

# GC2X10MPS12-247

1200 V SiC MPS™ Diode



## Silicon Carbide Schottky Diode

$V_{RRM}$	=	1200 V
$I_F$ ( $T_C = 135^\circ\text{C}$ )	=	48 A*
$Q_C$	=	80 nC*

### Features

- High Avalanche (UIS) Capability
- Enhanced Surge Current Capability
- Superior Figure of Merit  $Q_C/I_F$
- Low Thermal Resistance
- 175 °C Maximum Operating Temperature
- Temperature Independent Switching Behavior
- Positive Temperature Coefficient of  $V_F$
- Extremely Fast Switching Speeds

### Advantages

- Low Standby Power Losses
- Improved Circuit Efficiency (Lower Overall Cost)
- Low Switching Losses
- Ease of Paralleling without Thermal Runaway
- Smaller Heat Sink Requirements
- Low Reverse Recovery Current
- Low Device Capacitance
- Low Reverse Leakage Current

### Package

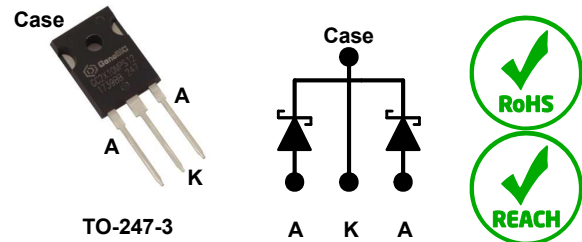

### Applications

- Boost Diode in Power Factor Correction (PFC)
- Switched Mode Power Supply (SMPS)
- Uninterruptible Power Supply (UPS)
- Motor Drives
- Freewheeling / Anti-parallel Diode in Inverters
- Solar Inverters
- LED and HID Lighting
- AC-DC Converters & Auxiliary Power Supplies

### Absolute Maximum Ratings (At $T_C = 25^\circ\text{C}$ Unless Otherwise Stated)

Parameter	Symbol	Conditions	Values	Unit
Repetitive Peak Reverse Voltage (Per Leg)	$V_{RRM}$		1200	V
Continuous Forward Current (Per Leg / Per Device)	$I_F$	$T_C = 25^\circ\text{C}, D = 1$	50/100	A
		$T_C = 135^\circ\text{C}, D = 1$	24/48	
		$T_C = 166^\circ\text{C}, D = 1$	10/20	
Non-Repetitive Peak Forward Surge Current, Half Sine Wave (Per Leg)	$I_{F,SM}$	$T_C = 25^\circ\text{C}, t_p = 10\text{ ms}$	82	A
		$T_C = 150^\circ\text{C}, t_p = 10\text{ ms}$	66	
Repetitive Peak Forward Surge Current, Half Sine Wave (Per Leg)	$I_{F,RM}$	$T_C = 25^\circ\text{C}, t_p = 10\text{ ms}$	50	A
		$T_C = 150^\circ\text{C}, t_p = 10\text{ ms}$	34	
Non-Repetitive Peak Forward Surge Current (Per Leg)	$I_{F,max}$	$T_C = 25^\circ\text{C}, t_p = 10\text{ }\mu\text{s}$	780	A
$i^2t$ Value (Per Leg)	$\int i^2 dt$	$T_C = 25^\circ\text{C}, t_p = 10\text{ ms}$	34	$\text{A}^2\text{s}$
Non-Repetitive Avalanche Energy (Per Leg)	$E_{AS}$	$L = 2.2\text{ mH}, I_{AS} = 10\text{ A}$	110	mJ
Diode Ruggedness (Per Leg)	$dV/dt$	$V_R = 0 \sim 960\text{ V}$	100	V/ns
Power Dissipation (Per Leg / Per Device)	$P_{tot}$	$T_C = 25^\circ\text{C}$	336/672	W
Operating and Storage Temperature	$T_j, T_{stg}$		-55 to 175	$^\circ\text{C}$

# GC2X10MPS12-247

1200 V SiC MPS™ Diode



## Electrical Characteristics (Per Leg)

Parameter	Symbol	Conditions	Values			Unit
			Min.	Typ.	Max.	
Diode Forward Voltage	$V_F$	$I_F = 10 \text{ A}, T_j = 25 \text{ }^\circ\text{C}$		1.5	1.8	V
		$I_F = 10 \text{ A}, T_j = 175 \text{ }^\circ\text{C}$		2	2.4	
Reverse Current	$I_R$	$V_R = 1200 \text{ V}, T_j = 25 \text{ }^\circ\text{C}$		1	10	$\mu\text{A}$
		$V_R = 1200 \text{ V}, T_j = 175 \text{ }^\circ\text{C}$		3	36	
Total Capacitive Charge	$Q_C$	$V_R = 400 \text{ V}$		27		nC
		$I_F \leq I_{F,MAX}$ $di_F/dt = 200 \text{ A}/\mu\text{s}$ $T_j = 175 \text{ }^\circ\text{C}$ $V_R = 800 \text{ V}$		40		
Switching Time	$t_s$	$V_R = 400 \text{ V}$		< 10		ns
		$V_R = 800 \text{ V}$				
Total Capacitance	C	$V_R = 1 \text{ V}, f = 1 \text{ MHz}, T_j = 25 \text{ }^\circ\text{C}$		660		pF
		$V_R = 800 \text{ V}, f = 1 \text{ MHz}, T_j = 25 \text{ }^\circ\text{C}$		50		

## Thermal / Mechanical Characteristics

Thermal Resistance, Junction – Case (Per Leg)	$R_{thJC}$		0.38	$^\circ\text{C}/\text{W}$
Weight	$W_T$		6.1	g
Mounting Torque	$T_M$		1.1	Nm

\* Per Device

# GC2X10MPS12-247

1200 V SiC MPS™ Diode

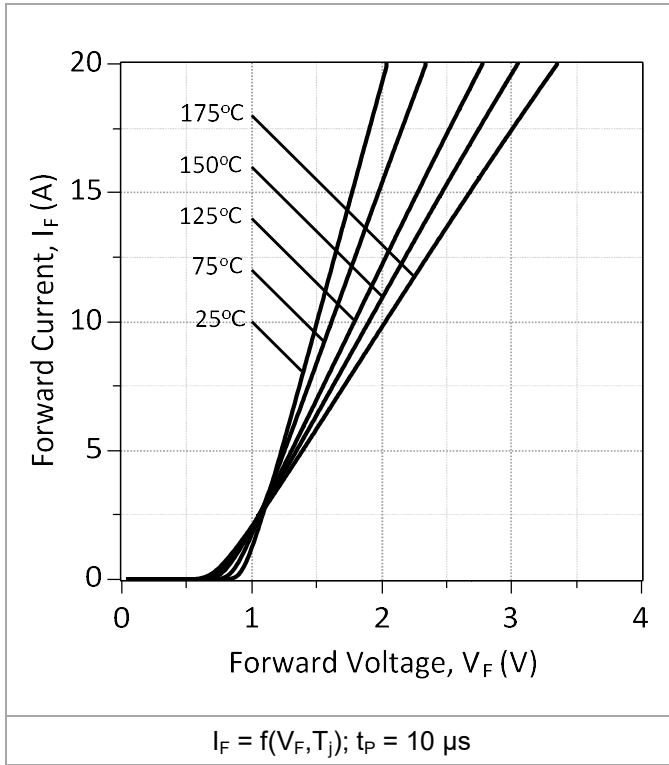

**Figure 1: Typical Forward Characteristics (Per Leg)**

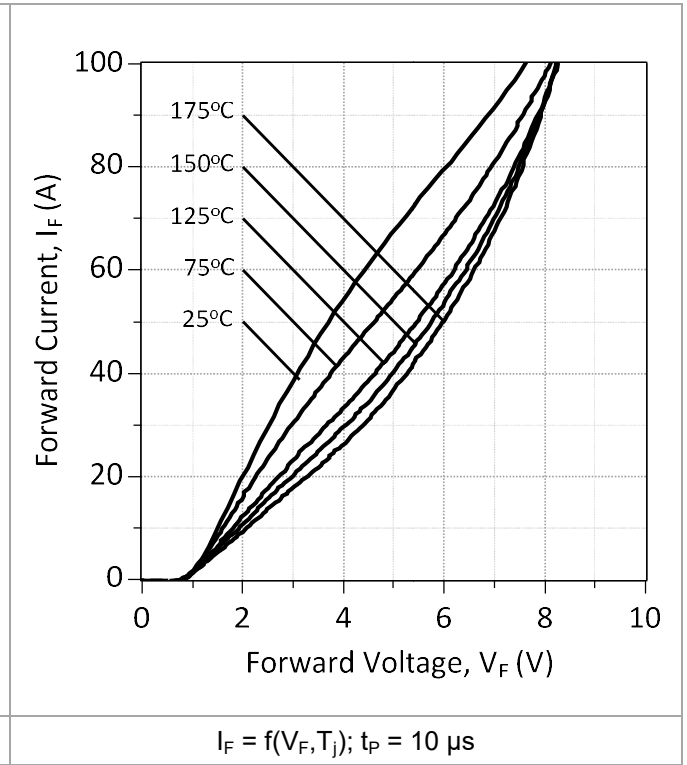

**Figure 2: Typical High Current Forward Characteristics (Per Leg)**

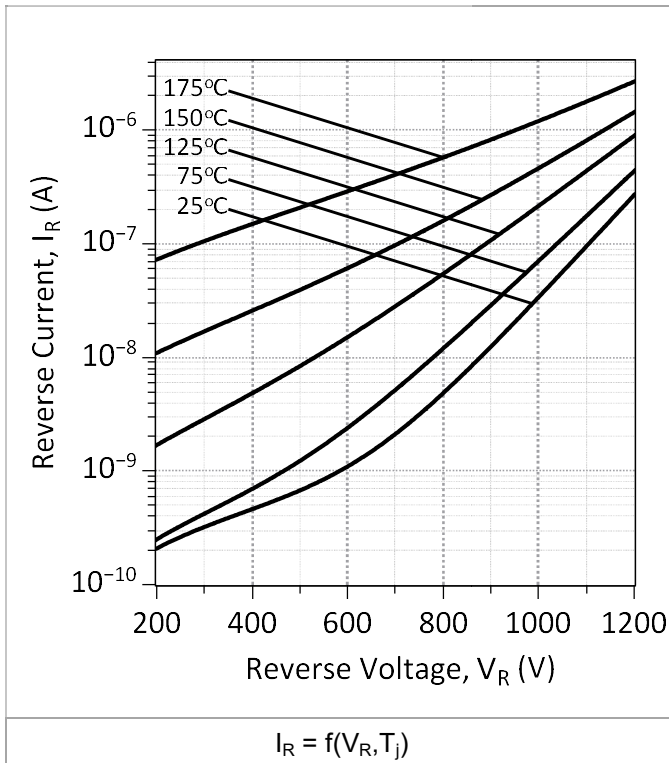

**Figure 3: Typical Reverse Characteristics (Per Leg)**

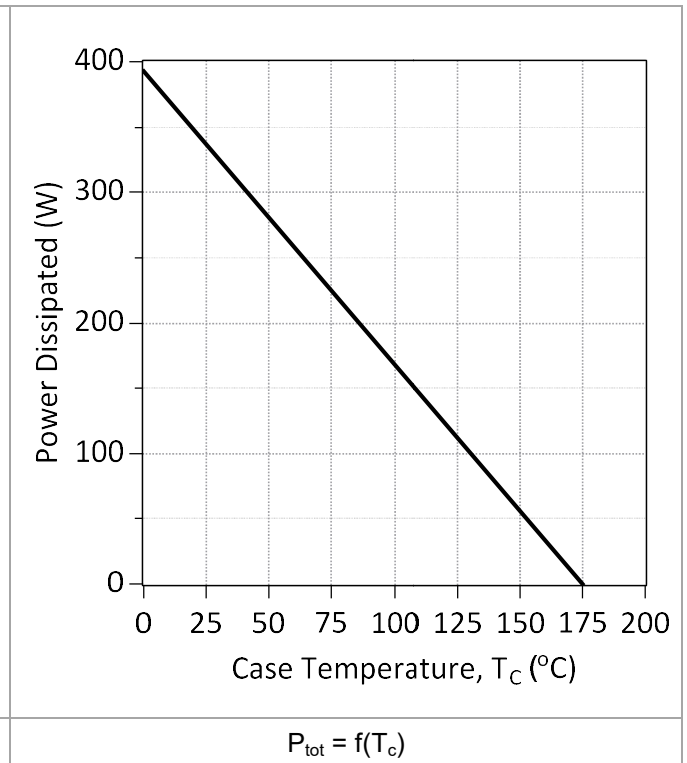
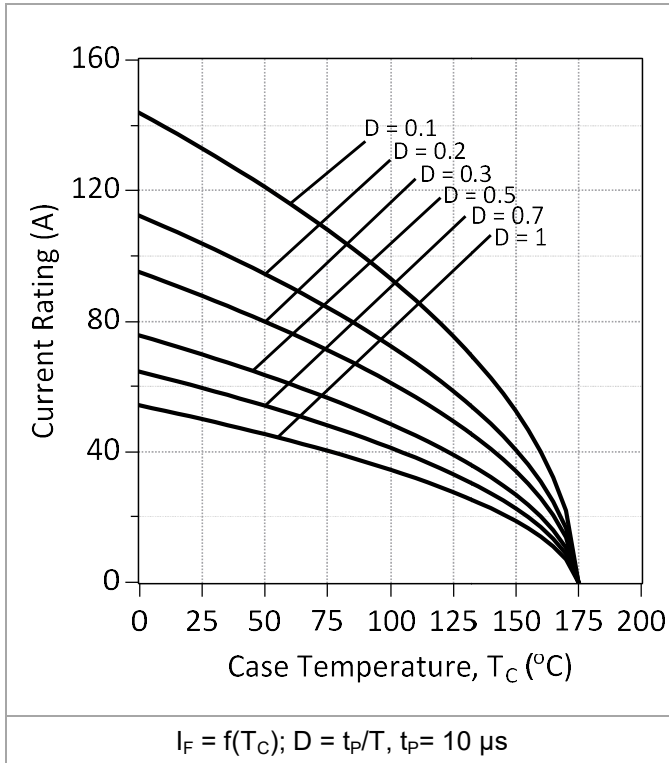

**Figure 4: Power Derating Curve (Per Leg)**



# GC2X10MPS12-247

1200 V SiC MPS™ Diode



**Figure 5: Current Derating Curves (Per Leg)**

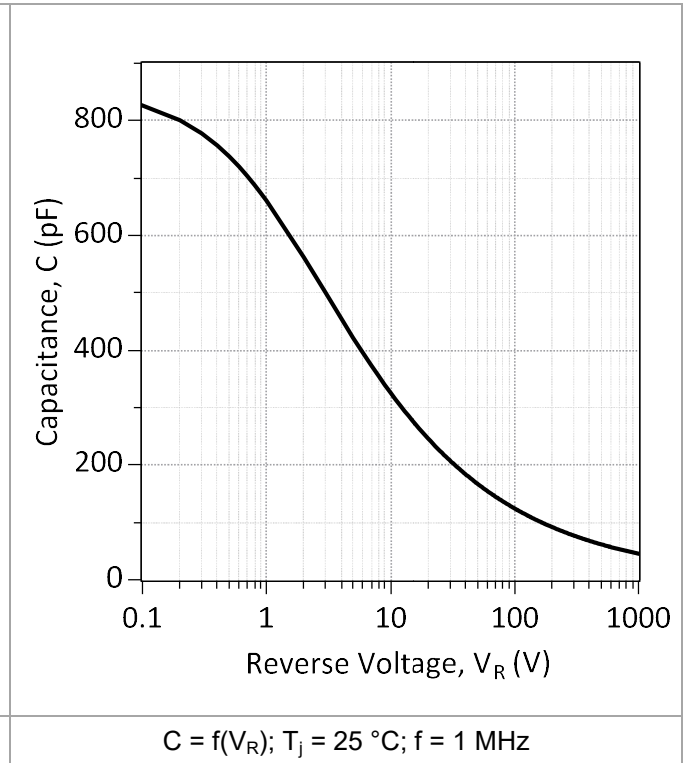

**Figure 6: Typical Junction Capacitance vs. Reverse Voltage Characteristics (Per Leg)**

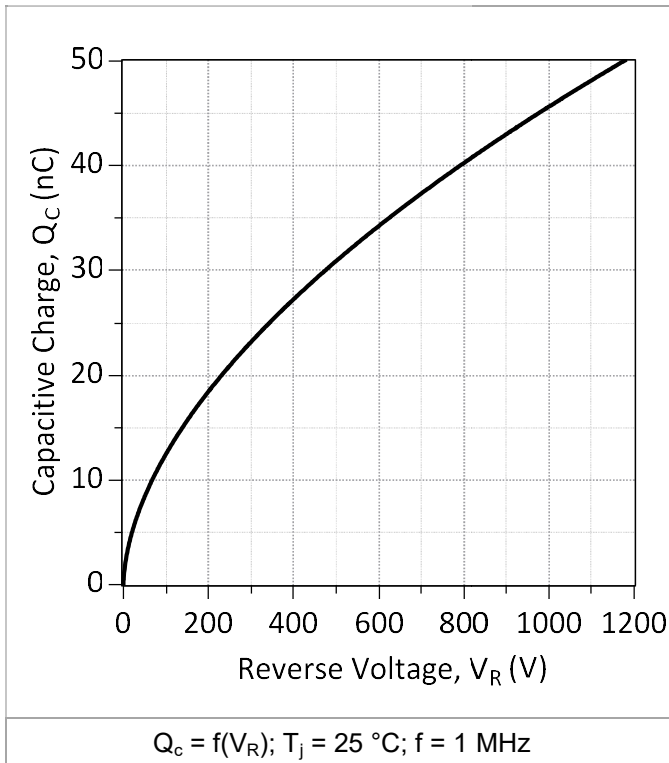

**Figure 7: Typical Capacitive Charge vs. Reverse Voltage Characteristics (Per Leg)**

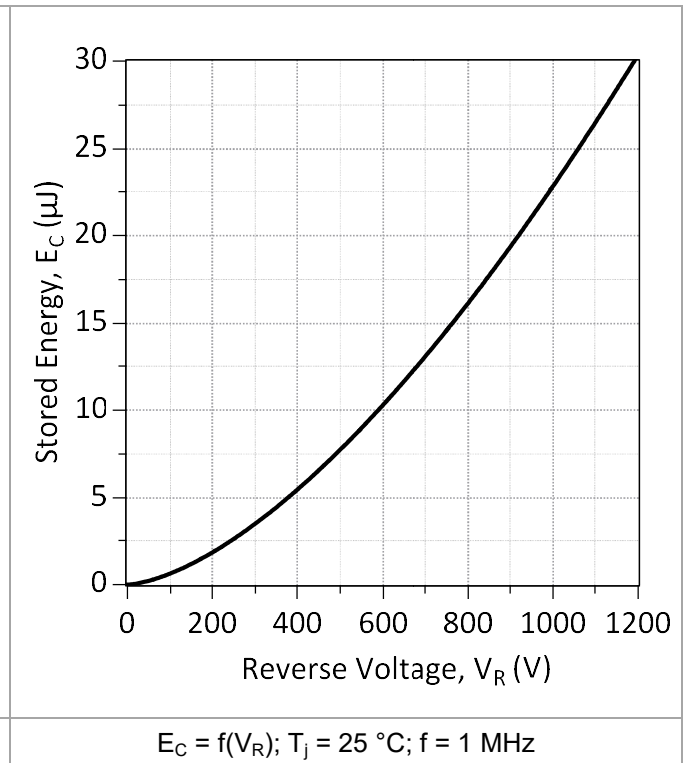

**Figure 8: Typical Capacitive Energy vs. Reverse Voltage Characteristics (Per Leg)**

# GC2X10MPS12-247

1200 V SiC MPS™ Diode

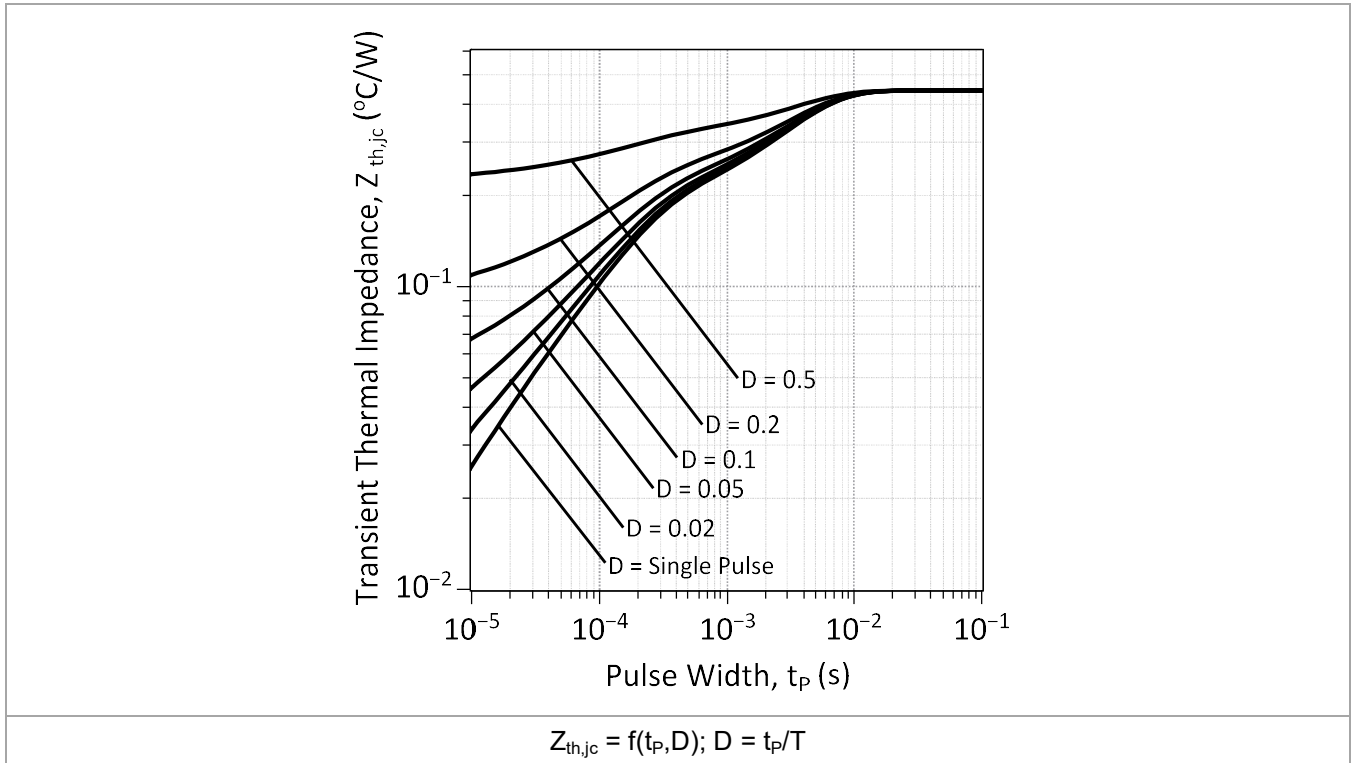

Figure 9: Transient Thermal Impedance (Per Leg)

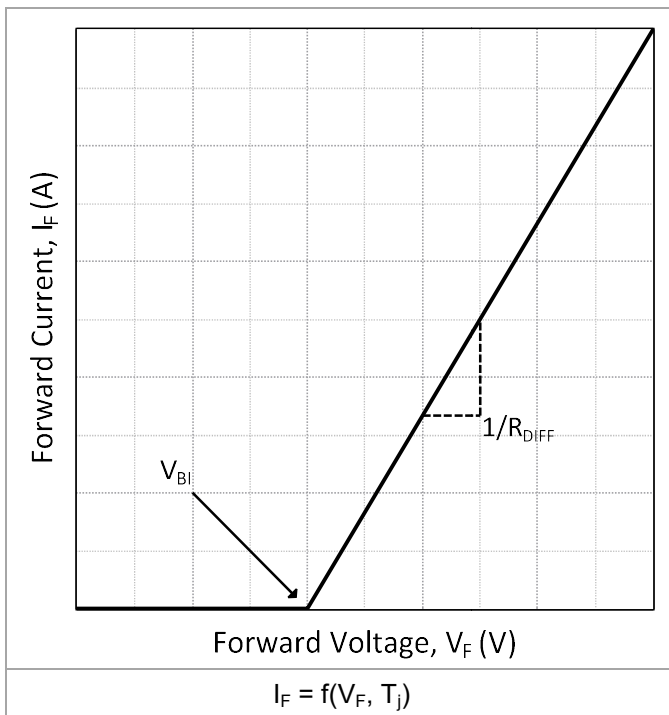

Figure 10: Forward Curve Model (Per Leg)

$$I_F = (V_F - V_{Bi})/R_{DIFF} \text{ (A)}$$

**Built-In Voltage ( $V_{Bi}$ ):**

$$V_{Bi}(T_j) = m \cdot T_j + n \text{ (V)},$$

$$m = -1.55e-03, n = 1.01$$

**Differential Resistance ( $R_{DIFF}$ ):**

$$R_{DIFF}(T_j) = a \cdot T_j^2 + b \cdot T_j + c \text{ (}\Omega\text{);}$$

$$a = 1.26e-06, b = 2.11e-04, c = 0.0447$$



# GC2X10MPS12-247

1200 V SiC MPS™ Diode



## Package Dimensions

TO-247-3L

Package Outline

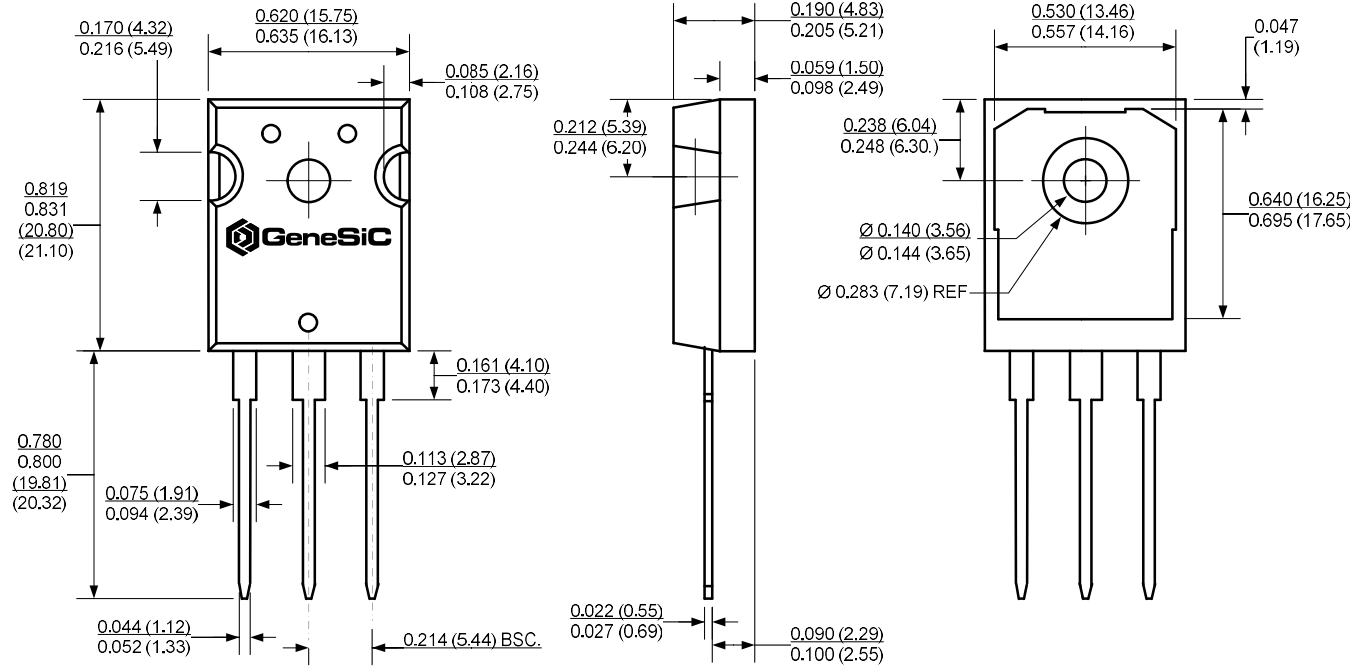

## Recommended Solder Pad Layout

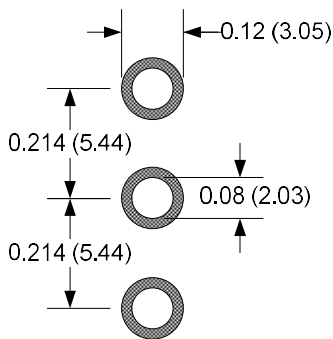

### NOTE

1. CONTROLLED DIMENSION IS INCH. DIMENSION IN BRACKET IS MILLIMETER.
2. DIMENSIONS DO NOT INCLUDE END FLASH, MOLD FLASH, MATERIAL PROTRUSIONS

## GC2X10MPS12-247

1200 V SiC MPS™ Diode



### RoHS Compliance

The levels of RoHS restricted materials in this product are below the maximum concentration values (also referred to as the threshold limits) permitted for such substances, or are used in an exempted application, in accordance with EU Directive 2011/65/EC (RoHS), as implemented November 15, 2017. RoHS Declarations for this product can be obtained from your GeneSiC representative.

### REACH Compliance

REACH substances of high concern (SVHCs) information is available for this product. Since the European Chemical Agency (ECHA) has published notice of their intent to frequently revise the SVHC listing for the foreseeable future, please contact a GeneSiC representative to insure you get the most up-to-date REACH SVHC Declaration. REACH banned substance information (REACH Article 67) is also available upon request.

This product has not been designed or tested for use in, and is not intended for use in, applications implanted into the human body nor in applications in which failure of the product could lead to death, personal injury or property damage, including but not limited to equipment used in the operation of nuclear facilities, life-support machines, cardiac defibrillators or similar emergency medical equipment, aircraft navigation or communication or control systems, or air traffic control systems.

GeneSiC disclaims all and any warranty and liability arising out of use or application of any product. No license, express or implied to any intellectual property rights is granted by this document.

### Related Links

- Soldering Document: <http://www.genesicsemi.com/technical-support/quality/>
- Tin-Whisker Report: <http://www.genesicsemi.com/technical-support/compliance/>
- Reliability Report: <http://www.genesicsemi.com/technical-support/reliability/>