

## Silicon Standard Recovery Diode

$V_{RRM} = 100\text{ V} - 600\text{ V}$

$I_F = 25\text{ A}$

### Features

- High Surge Capability
- Types from 100 V to 600 V  $V_{RRM}$
- Not ESD Sensitive

### Note:

1. Standard polarity: Stud is cathode.
2. Reverse polarity (R): Stud is anode.
3. Stud is base.

DO-4 Package

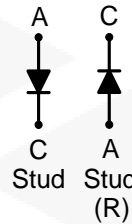

### Maximum ratings, at $T_j = 25\text{ }^\circ\text{C}$ , unless otherwise specified ("R" devices have leads reversed)

Parameter	Symbol	Conditions	S25B (R)	S25D (R)	S25G (R)	S25J (R)	Unit
Repetitive peak reverse voltage	$V_{RRM}$		100	200	400	600	V
RMS reverse voltage	$V_{RMS}$		70	140	280	420	V
DC blocking voltage	$V_{DC}$		100	200	400	600	V
Continuous forward current	$I_F$	$T_C \leq 120\text{ }^\circ\text{C}$	25	25	25	25	A
Surge non-repetitive forward current, Half Sine Wave	$I_{F,SM}$	$T_C = 25\text{ }^\circ\text{C}$ , $t_p = 8.3\text{ ms}$	373	373	373	373	A
Operating temperature	$T_j$		-55 to 150	-55 to 150	-55 to 150	-55 to 150	$^\circ\text{C}$
Storage temperature	$T_{stg}$		-55 to 150	-55 to 150	-55 to 150	-55 to 150	$^\circ\text{C}$

### Electrical characteristics, at $T_j = 25\text{ }^\circ\text{C}$ , unless otherwise specified

Parameter	Symbol	Conditions	S25B (R)	S25D (R)	S25G (R)	S25J (R)	Unit
Diode forward voltage	$V_F$	$I_F = 25\text{ A}$ , $T_j = 25\text{ }^\circ\text{C}$	1.1	1.1	1.1	1.1	V
Reverse current	$I_R$	$V_R = 50\text{ V}$ , $T_j = 25\text{ }^\circ\text{C}$	10	10	10	10	$\mu\text{A}$
		$V_R = 50\text{ V}$ , $T_j = 175\text{ }^\circ\text{C}$	12	12	12	12	mA

### Thermal characteristics

Thermal resistance, junction - case	$R_{thJC}$		2.50	2.50	2.50	2.50	$^\circ\text{C/W}$
-------------------------------------	------------	--	------	------	------	------	--------------------

Figure .1-Typical Forward Characteristics

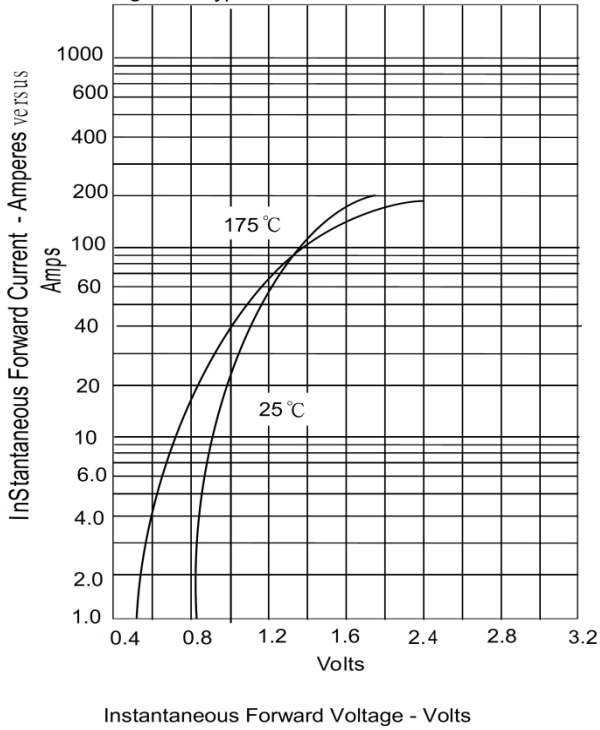

Figure .2-Forward Derating Curve

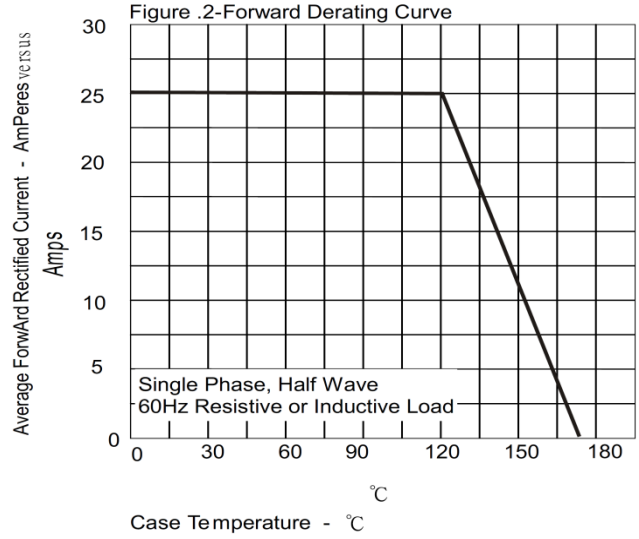

Figure .4-Typical Reverse Characteristics

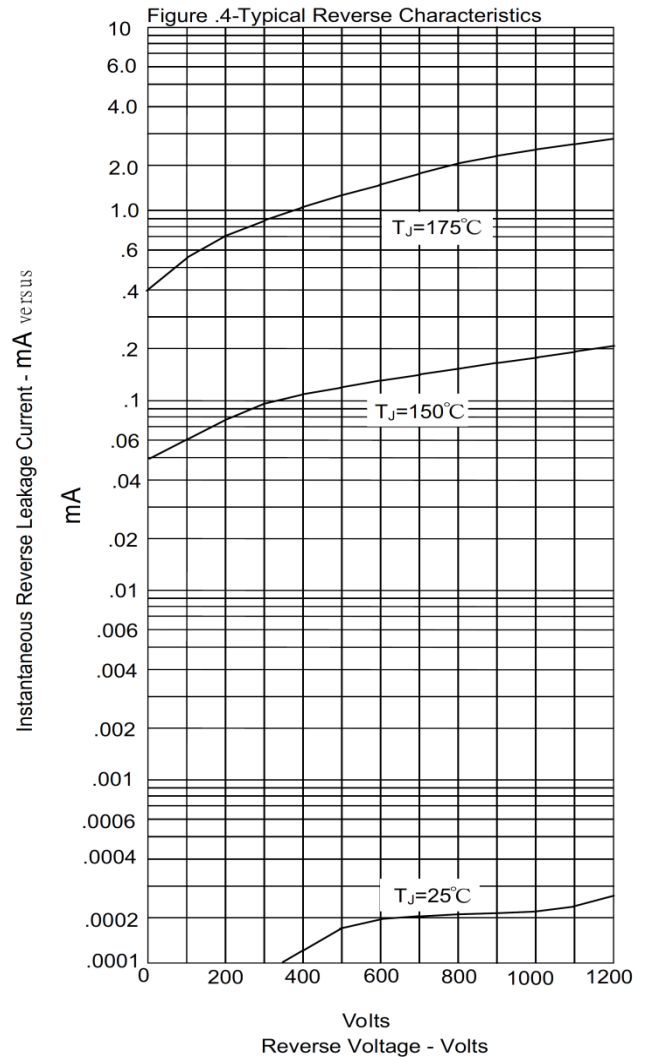
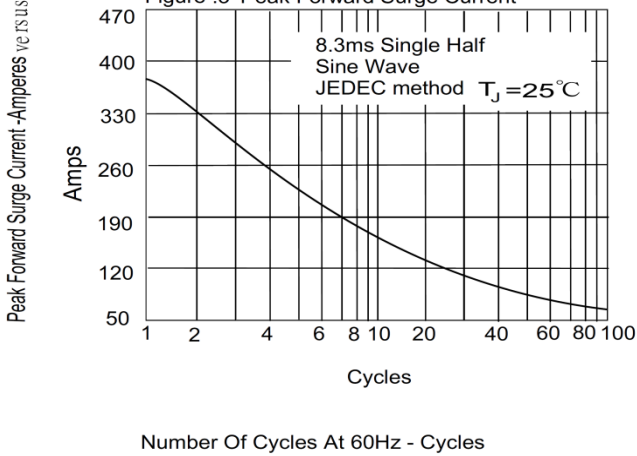
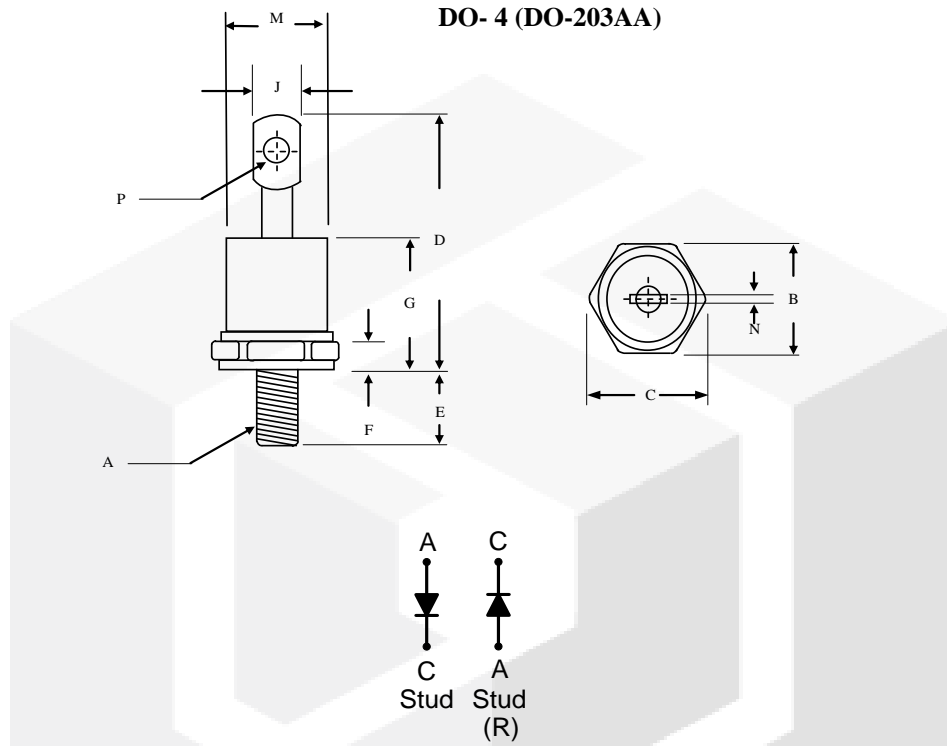

Figure .3-Peak Forward Surge Current



**Package dimensions and terminal configuration**

Product is marked with part number and terminal configuration.



	Inches		Millimeters	
	Min	Max	Min	Max
A	10-32 UNF			
B	0.424	0.437	10.77	11.10
C	-----	0.505	-----	12.82
D	-----	0.800	-----	20.30
E	0.453	0.492	11.50	12.50
F	0.114	0.140	2.90	3.50
G	-----	0.405	-----	10.29
J	-----	0.216	-----	5.50
M	-----	φ0.302	-----	φ7.68
N	0.031	0.045	0.80	1.15
P	0.070	0.79	1.80	2.00