



GT25C128

SPI

128K Bits

Serial EEPROM

Copyright © 2011 Giantec Semiconductor Inc. (Giantec). All rights reserved. Giantec reserves the right to make changes to this specification and its products at any time without notice. Giantec products are not designed, intended, authorized or warranted for use as components in systems or equipment intended for critical medical or surgical equipment, aerospace or military, or other applications planned to support or sustain life. It is the customer's obligation to optimize the design in their own products for the best performance and optimization on the functionality and etc. Giantec assumes no liability arising out of the application or use of any information, products or services described herein. Customers are advised to obtain the latest version of this device specification before relying on any published information and prior placing orders for products



GT25C128

Table of Contents

1. Features	3
2. General Description	3
3. Functional Block Diagram	4
4. Pin Configuration	5
4.1 8-Pin SOIC and TSSOP	5
4.2 Pin Definition	5
4.3 Pin Descriptions	5
5. Device Operation	6
5.1 Status Register	6
5.2 Op-Code Instructions	7
5.3 Write Enable	7
5.4 Write Disable	7
5.5 Read Status Register	7
5.6 Write Status Register	7
5.7 Read Data	8
5.8 Write Data	8
5.9. Diagrams	9
6. Electrical Characteristics	12
6.1 Absolute Maximum Ratings	12
6.2 Operating Range	12
6.3 Capacitance	12
6.4 DC Electrical Characteristic	13
6.5 AC Electrical Characteristic	14
7. Ordering Information	15
8. Top Markings	16
8.1 SOIC Package	16
8.2 TSSOP Package	16
9. Package Information	17
9.1 SOIC	17
9.2 TSSOP	18
10. Revision History	19



GT25C128

1. Features

- Serial Peripheral Interface (SPI) Compatible
 - Supports Mode 0 (0,0) and Mode 3 (1,1)
- Wide-voltage Operation
 - $V_{CC} = 1.8V$ to $5.5V$
- Low power CMOS
 - Standby current: $\leq 15 \mu A$ ($1.8V$)
 - Operating current: $\leq 3 mA$ ($1.8V$)
- Operating frequency: $5 MHz$ ($5.5V$)
- Memory organization: $128Kb$ ($16,384 \times 8$)
- Byte and Page write (up to 64 bytes)
 - Partial page write allowed
- Block Write Protection
 - Protect 1/4, 1/2, or Entire Array
- Self timed write cycle: $5 ms$ (max.)
- High-reliability
 - Endurance: 1 million cycles
 - Data retention: 100 years
- Industrial temperature grade
- Packages (8-pin): SOIC and TSSOP
- Lead-free, RoHS, Halogen free, Green

2. General Description

The GT25C128 is an industrial standard electrically erasable programmable read only memory (EEPROM) product that utilizes standard Serial Peripheral Interface (SPI) for communications. The GT25C128 contains a memory array of $128K$ bits ($16,384 \times 8$), which is organized in 64 bytes per page.

This EEPROM operates in a wide voltage range from $1.8V$ to $5.5V$, which fits most application. The device provides low-power operations and low standby current. The product is offered in Lead-free, RoHS, halogen free or Green package. The available package types are 8-pin SOIC and TSSOP.

The functionalities of the GT25C128 are optimized for most applications, such as consumer electronics, wireless, telecommunication, industrial, medical, instrumentation, commercial and others, where low-power and low-voltage are vital. This product has a compatible SPI interface: Chip-Select (\overline{CS}), Serial Data In (SI), Serial Data Out (SO) and Serial Clock (SCK) for high-speed communication. Furthermore, a Hold feature via \overline{HOLD} pin allows the device entering into a suspended state whenever necessary and resuming the communication without re-initializing the serial sequence. A Status Register facilitates a flexible write protection mechanism and device

status monitoring. The GT25C128 also offers an additional page, named the Identification Page (64 bytes) which can be written and (later) permanently locked in Read-only mode. This Identification Page offers flexibility in the application board production line, as the Identification Page can be used to store unique identification parameters and/or parameters specific to the production line.

In order to refrain the state machine from entering into a wrong state during power-up sequence or a power toggle off-on condition, a power on reset circuit is implemented. During power-up, the device does not respond to any instructions until the supply voltage (V_{CC}) has reached an acceptable stable level above the reset threshold voltage. Once V_{CC} passes the power on reset threshold, the device is reset and enters into Standby mode. This should also avoid any inadvertent Write operations during power-up stage. During power-down process, the device will enter into standby mode, once V_{CC} drops below the power on reset threshold voltage. In addition, the device will be in standby mode after receiving the Stop command, provided that no internal write operation is in progress. Nevertheless, it is illegal to send a command unless the V_{CC} is within its operating level.



GT25C128

3. Functional Block Diagram

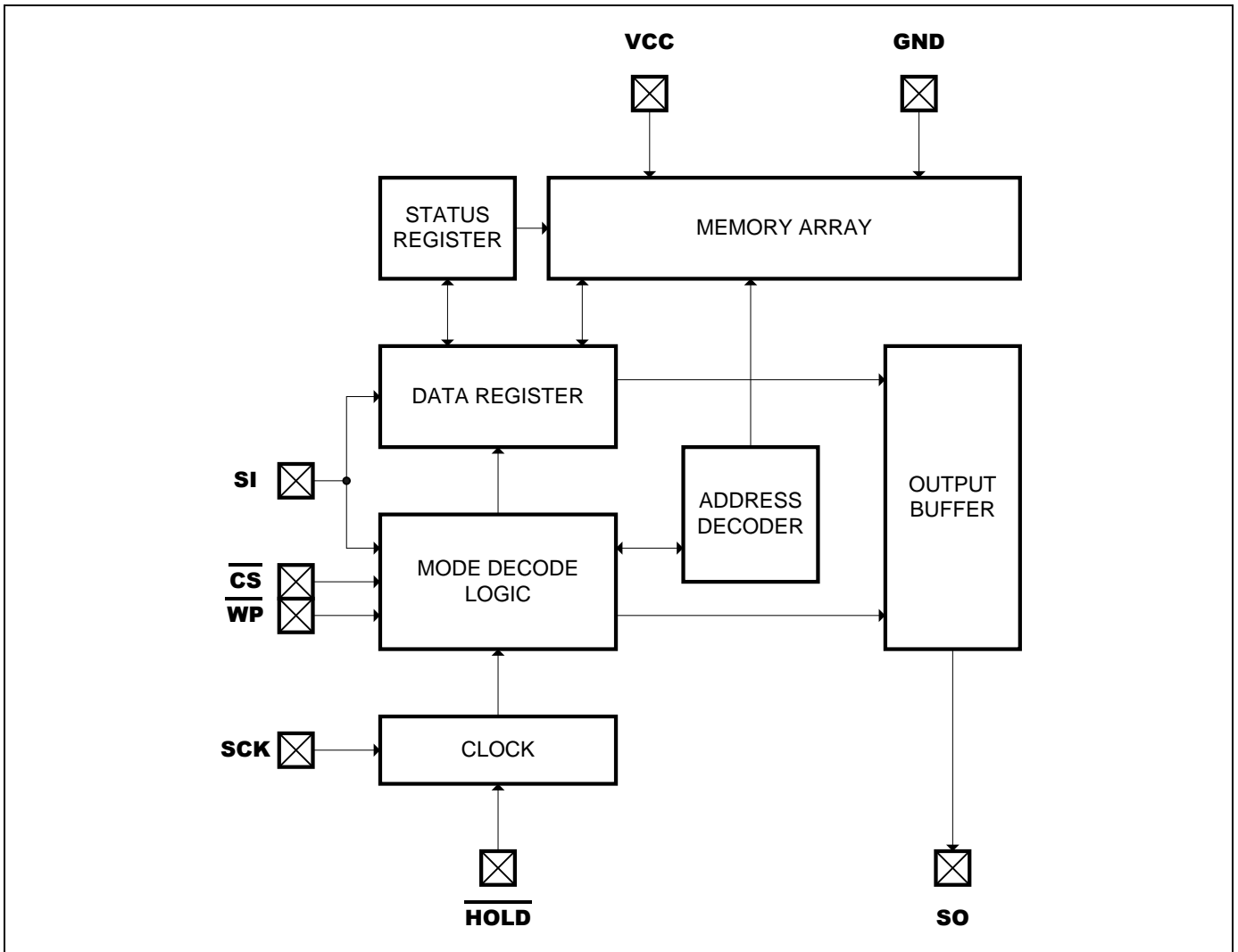

Serial Interface Description

- Master:** The device that provides a clock signal.
- Slave:** GT25C128.
- Transmitter/Receiver:** The GT25C128 has both data input (SI) and data output (SO).
- MSB** MSB (Most Significant Bit) is the first bit being transmitted or received.
- Op-Code:** Operational instruction code typically sent to the GT25C128 is the first byte of information transmitted after \overline{CS} is Low. If the Op-Code is a valid instruction as listed in Table 5.3, then it will be decoded appropriately. It is prohibited to send an invalid Op-Code.



GT25C128

4. Pin Configuration

4.1 8-Pin SOIC and TSSOP

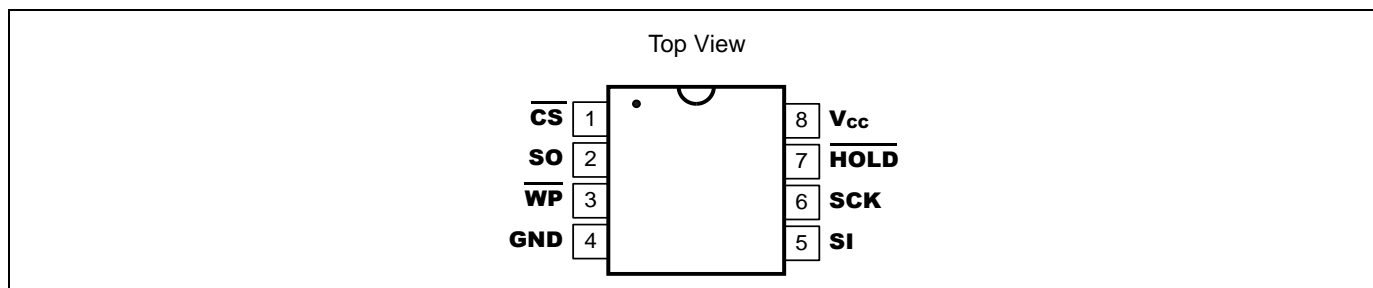

4.2 Pin Definition

Pin No.	Pin Name	I/O	Definition
1	$\overline{\text{CS}}$	I	Chip Select
2	SO	O	Serial Data Output
3	$\overline{\text{WP}}$	I	Write Protect Input
4	GND	-	Ground
5	SI	I	Serial Data Input
6	SCK	I	Serial Clock
7	$\overline{\text{HOLD}}$	I	Hold function
8	V _{CC}	-	Supply Voltage

4.3 Pin Descriptions

Chip Select ($\overline{\text{CS}}$)

The $\overline{\text{CS}}$ pin is used to enable or disable the device. Upon power-up, $\overline{\text{CS}}$ must follow the supply voltage. When the device is ready for instruction input, this signal requires a High-to-Low transition. Once $\overline{\text{CS}}$ is stable at Low, the device is enabled. Then the master and slave can communicate among each other through SCK, SI, and SO pins. Upon completion of transmission, $\overline{\text{CS}}$ must be driven to High in order to stop the operation or start the internal write operation. And the device will enter into standby mode, unless an internal write operation is in progress. During this mode, SO becomes high impedance.

Serial Clock (SCK)

Under the SPI modes (0, 0) and (1, 1), this clock signal provides synchronization between the master and GT25C128. Typically, Op-Codes, addresses and data are latched from SI at the rising edge of SCK, while data from SO are clocked out at the falling edge of SCK.

Serial Data Input (SI)

Data Input pin.

Serial Data Output (SO)

Data output pin.

Write Protect ($\overline{\text{WP}}$)

This active Low input signal is utilized to initiate Hardware Write Protection mode. This mode prevents the Block Protection bits and the WPEN bit in the Status Register from being modified. To activate the Hardware Write Protection, $\overline{\text{WP}}$ must be Low simultaneously when WPEN is set to 1.

Hold ($\overline{\text{HOLD}}$)

This feature is used to suspend the device in the middle of a serial sequence and temporarily ignore further communication on the bus (SI, SO, SCK). The $\overline{\text{HOLD}}$ signal transitions must occur only when SCK is Low and be held stable during SCK transitions. Connecting $\overline{\text{HOLD}}$ to High disables this feature. Figure. 5-8 shows Hold timing.



GT25C128

5. Device Operation

5.1 Status Register

The Status Register accessible by the user consists of 8-bits data for write protection control and write status. It

becomes Read-Only under any of the following conditions:
Hardware Write Protection is enabled or WEN is set to 0. If neither is true, it can be modified by a valid instruction.

Table 5.1: Status Register

Bit	Symbol	Name	Description
0	$\overline{\text{RDY}}$	Ready	When $\overline{\text{RDY}} = 0$, device is ready for an instruction. When $\overline{\text{RDY}} = 1$, device is busy. As busy, device only accepts Read Status Register command.
1	WEN	Write Enable	This represents the write protection status of the device. When WEN = 0, Status Register and entire array cannot be modified, regardless the setting of WPEN, $\overline{\text{WP}}$ pin or block protection. Write Enable command (WREN) can be used to set WEN to 1. Upon power-up stage, WEN is reset to 0.
2	BP0	Block Protect Bit	Despite of the status on WPEN, $\overline{\text{WP}}$ or WEN, BP0 and BP1 configure any combinations of the four blocks being protected (Table 5.2). They are non-volatile memory and programmed to 0 by factory. Values can be either 0 or 1, but are not retained. Mostly always 0, except during write operation.
3	BP1	Block Protect Bit	
4	X	Don't Care	
5	X	Don't Care	This bit can be utilized to enable Hardware Write Protection, together with $\overline{\text{WP}}$ pin. If enabled, Status Register becomes read-only. However, the memory array is not protected by this mode. Hardware Write Protection requires the setting of $\overline{\text{WP}} = 0$ and WPEN = 1. Otherwise, it is disabled. WPEN cannot be altered from 1 to 0 if $\overline{\text{WP}}$ is already set to Low. (Table 5.4 for write protection)
6	X	Don't Care	
7	WPEN	Write Protect Enable	

Note: During internal write cycles, bits 0 to 7 are temporarily 1's.

Table 5.2: Block Protection by BP0 and BP1

Level	Status Register Bits		Array Addresses Protected
	BP1	BP0	
0	0	0	None
1 (1/4)	0	1	3000h-3FFFh
2 (1/2)	1	0	2000h-3FFFh
3 (All)	1	1	0000h-3FFFh



GT25C128

5.2 Op-Code Instructions

The operations of the GT25C128 are controlled by a set of instruction Op-Codes (Table 5.3) that are clocked-in serially via SI pin. To initiate an instruction, the chip select (\overline{CS}) must be Low. Subsequently, each Low-to-High transition of the clock (SCK) will latch a stable level from SI. After the 8-bit Op-Code, it may continue to latch-in an address and/or data from SI accordingly, or to output data from SO. During

data output, data are latched out at the falling edge of SCK. All communications start with MSB first. Upon the transmission of the last bit but prior to any following Low-to-High transition on SCK, \overline{CS} must be brought to High in order to end the transaction and start the operation. The device will enter into Standby Mode after the operation is completed.

Table 5.3: Instruction Op-Codes^[1,2,3]

Name	Op-Code	Operation	Address	Data (SI)	Data (SO)
WREN	0000 X110	Set Write Enable Latch	-	-	-
WRDI	0000 X100	Reset Write Enable Latch	-	-	-
RDSR	0000 X101	Read Status Register	-	-	D ₇ -D ₀ -
WRSR	0000 X001	Write Status Register	-	D ₇ -D ₀	-
READ	0000 X011	Read Data from Array	A ₁₅ -A ₀	-	D ₇ -D ₀ , ...
WRITE	0000 X010	Write Data to Array	A ₁₅ -A ₀	D ₇ -D ₀ , ...	-

Notes: ^[1] X = Don't care bit. However, it is recommended to be "0".

^[2] Some address bits may be don't care (Table 5.5).

^[3] It is strongly recommended that an appropriate format of Op-Code must be entered. Otherwise, it may cause unexpected phenomenon to be occurred. Nevertheless, it is illegal to input invalid any Op-Code.

^[4] Address bit A10 must be 0, all other address bits are Don't Care.

^[5] Address bit A10 must be 1, all other address bits are Don't Care.

5.3 Write Enable

When V_{CC} is initially applied, the device powers up with both status register and entire array in a write-disabled state. Upon completion of Write Disable (WRDI), Write Status Register (WRSR) or Write Data to Array (WRITE), the device resets the WEN bit in the Status Register to 0. Prior to any data modification, a Write Enable (WREN) instruction is necessary to set WEN to 1 (Figure. 5-2).

5.4 Write Disable

The device can be completely protected from modification by resetting WEN to 0 through the Write Disable (WRDI) instruction (Figure. 5-3).

5.5 Read Status Register

The Read Status (RDSR) instruction reviews the status of Write Protect Enable, Block Protection setting (Table 5.2), Write Enable state and \overline{RDY} status. RDSR is the only instruction accepted when a write cycle is underway. It is

recommended that the status of Write Enable and \overline{RDY} be checked, especially prior to an attempted modification of data. These 8 bits information can be repeatedly output on SO after the initial Op-Code (Figure. 5-4).

5.6 Write Status Register

The Write Status Register (WRSR) instruction allows the user to choose a Block Protection setting and set or reset the WPEN bit. The values of the other data bits incorporated into WRSR can be 0 or 1 and are not stored in the Status Register. WRSR will be ignored unless both following conditions are true: a) WEN = 1, due to a prior WREN instruction; and b) Hardware Write Protection is not enabled (Table 5.4). Except for \overline{RDY} status, the values in the Status Register remain unchanged until the moment when the write cycle is completed and the register is updated. Note that WPEN can be changed from 1 to 0 only if \overline{WP} is already set High. Once completed, WEN is reset



GT25C128

for complete chip write protection (Fig. 5-5).

5.7 Read Data

This instruction includes an Op-Code and 16-bit address, then results the selected data to be shifted out from SO. Following the first data byte, additional sequential data can be output. If the data byte of the last address is initially output, then address will rollover to the first address in the array, and the output could loop indefinitely. At any time, a rising \overline{CS} signal ceases the operation (Figure. 5-6).

5.8 Write Data

The WRITE instruction contains an Op-Code, a 16-bit address and the first data byte. Additional data bytes may be supplied sequentially after the first byte. Each WRITE instruction can affect up to 64 bytes of data in a page. Each page has a starting address XXXXXXXX XX000000 and an

ending address XXXXXXXX XX111111. After the last byte of data in a page is input, the address rolls over to the beginning of the same page. If more than 64 bytes of data is input during a single instruction, then only the last 64 bytes will be retained, but the initial data will be overwritten.

The contents of the array defined by Block Protection cannot be modified as long as that block configuration is selected. The contents of the array outside the Block Protection can only be modified if Write Enable (WEN) is set to 1. Therefore, it may be necessary that a WREN instruction is initiated prior to WRITE. Once Write operation is completed, WEN is reset for complete chip write protection (Figure. 5-7). Besides, Hardware Write Protection has no affect on the memory array.

Table 5.4: Write Protection

WPEN	\overline{WP}	Hardware Write Protection	WEN	Inside Block	Outside Block	Status Register (WPEN, BP1, BP0)
0	X	Not Enabled	0	Read-only	Read-only	Read-only
0	X	Not Enabled	1	Read-only	Unprotected	Unprotected
1	0	Enabled	0	Read-only	Read-only	Read-only
1	0	Enabled	1	Read-only	Unprotected	Read-only
X	1	Not Enabled	0	Read-only	Read-only	Read-only
X	1	Not Enabled	1	Read-only	Unprotected	Unprotected

Note: X = Don't care bit.

Table 5.5: Address Key

Name	GT25C128
A_N	$A_{13}-A_0$
Don't Care Bits	$A_{15}-A_{14}$



GT25C128

5.9. Diagrams

Figure 5-1. Synchronous Data Timing

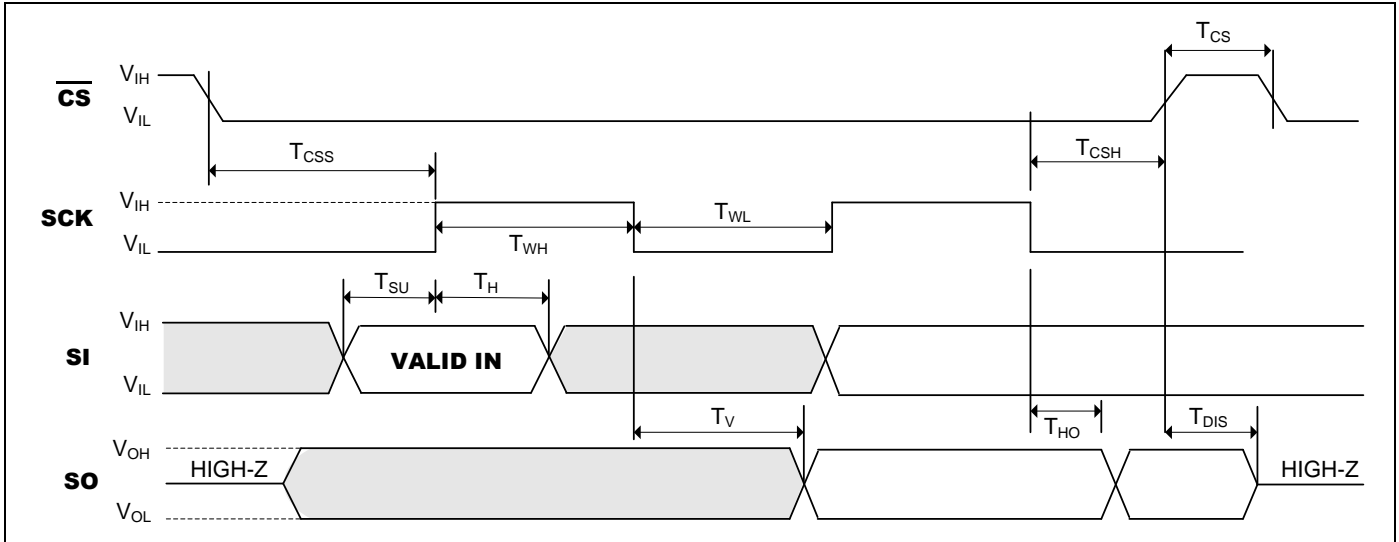

Figure 5-2. WREN Timing

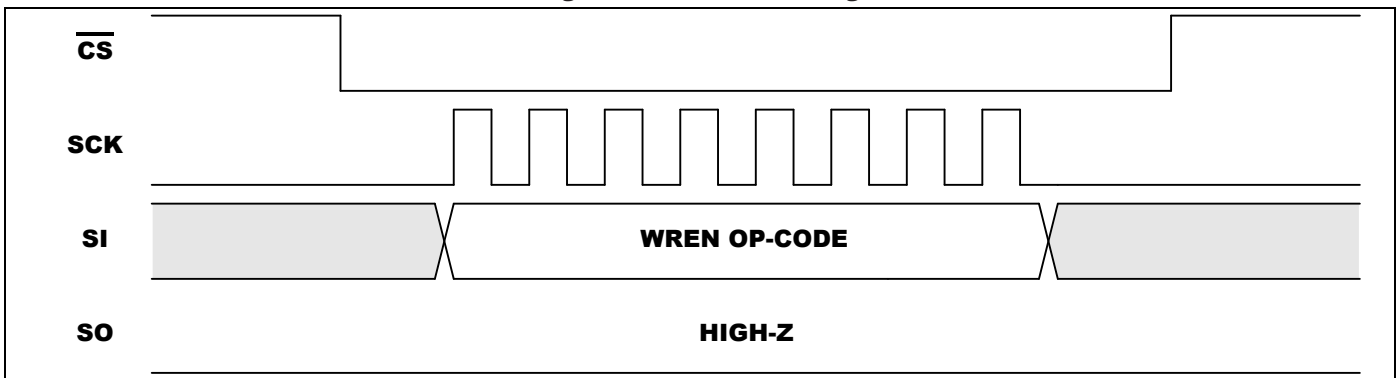
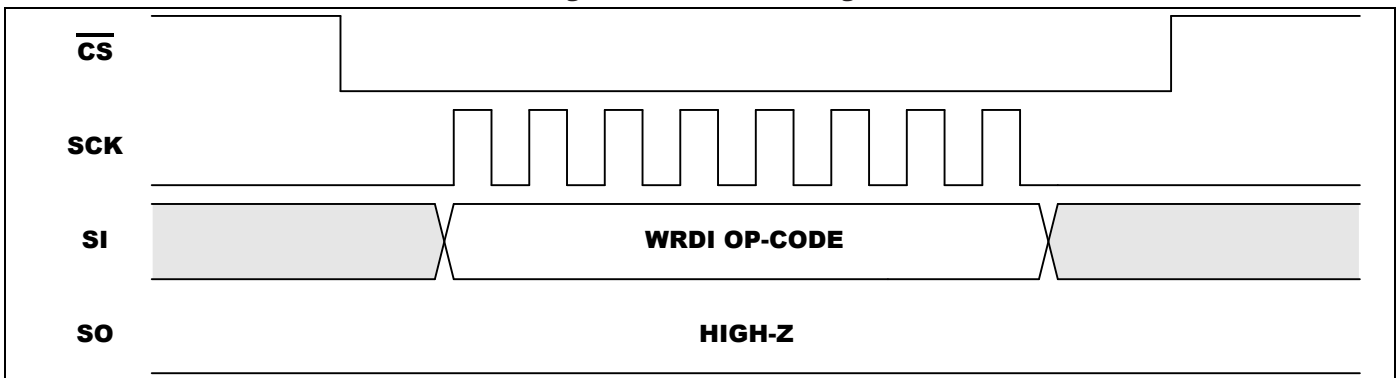

Figure 5-3. WRDI Timing





GT25C128

Figure 5-4. RDSR Timing

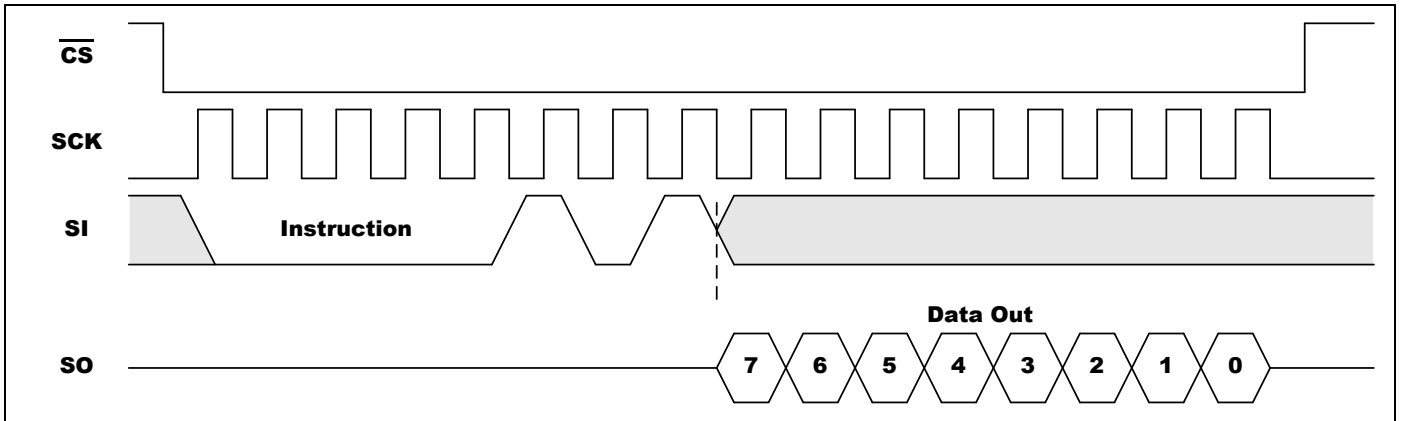

Figure 5-5. WRSR Timing

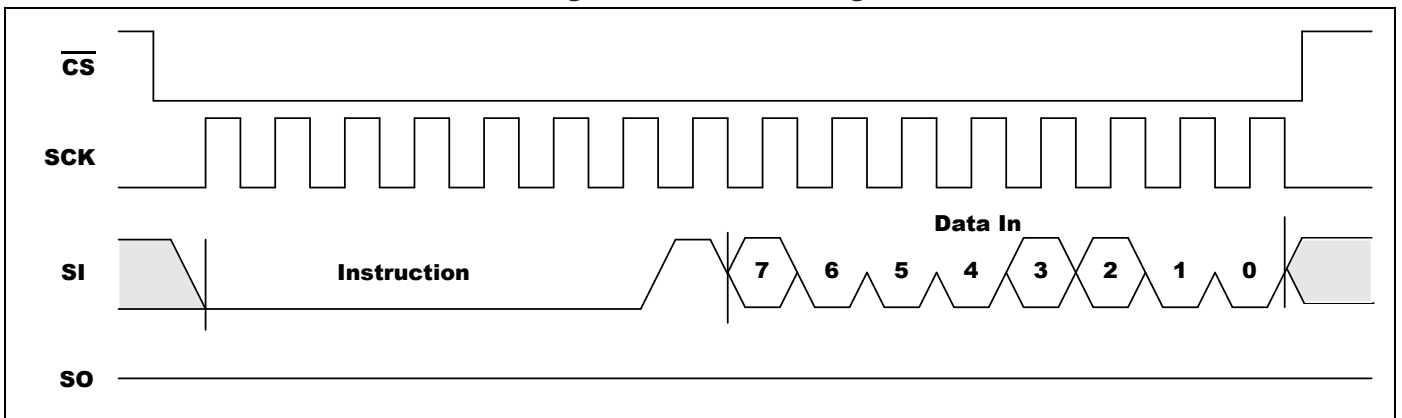
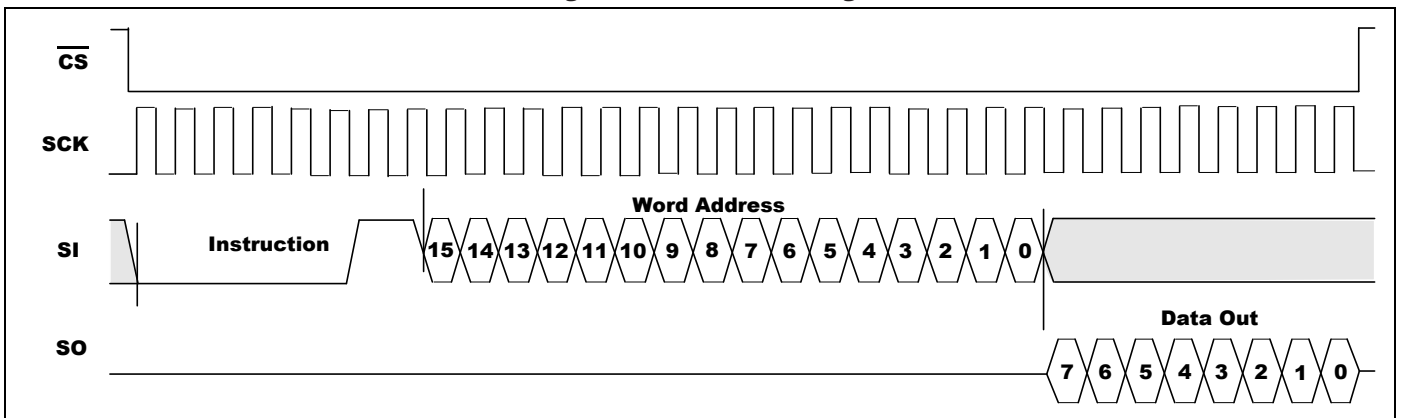

Figure 5-6. READ Timing





GT25C128

Figure 5-7. WRITE Timing

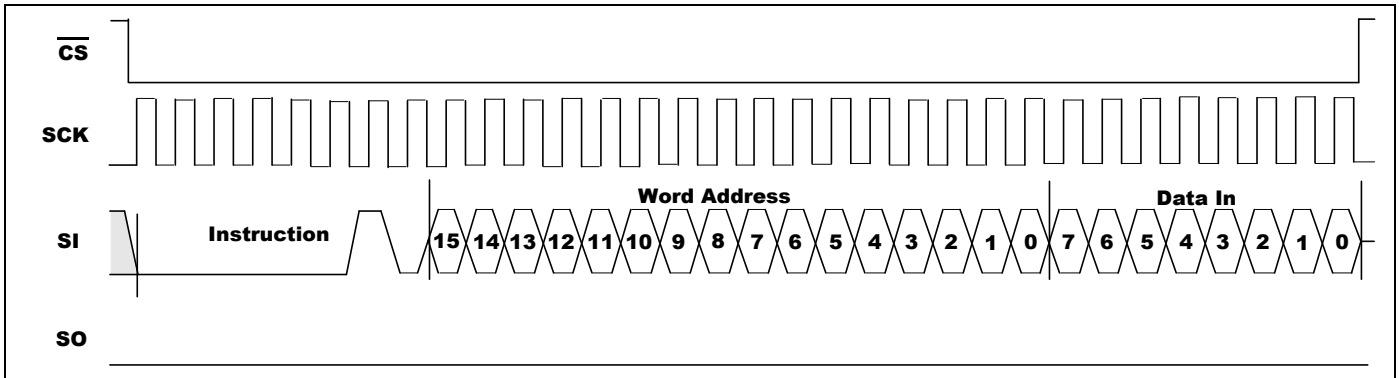
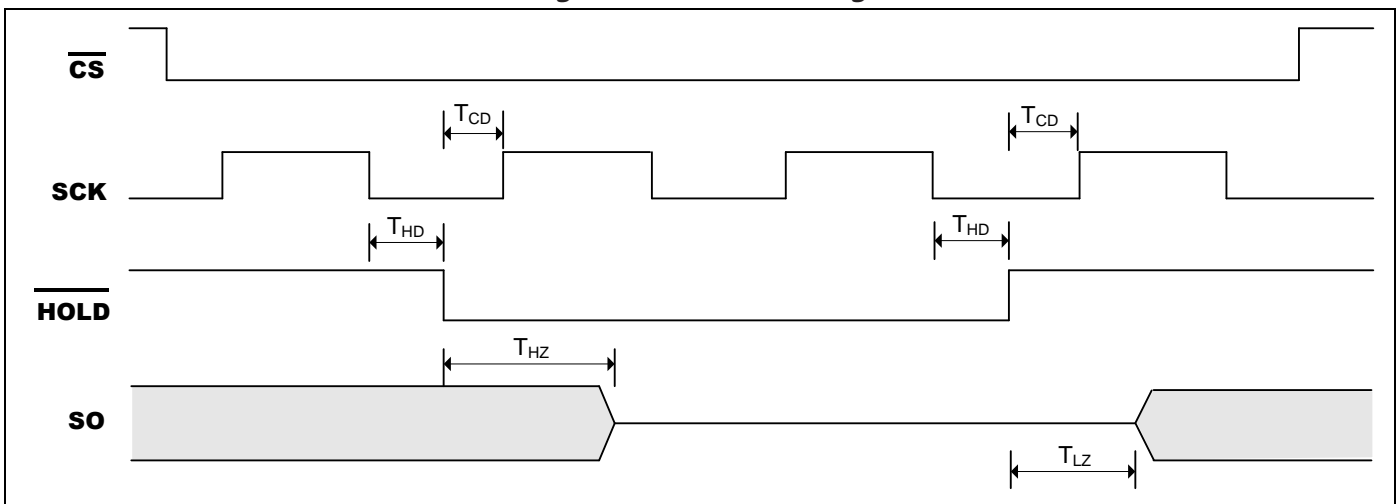

Figure 5-12. HOLD Timing





GT25C128

6. Electrical Characteristics

6.1 Absolute Maximum Ratings

Symbol	Parameter	Value	Unit
V_S	Supply Voltage	-0.5 to + 6.5	V
V_P	Voltage on Any Pin	-0.5 to $V_{CC} + 0.5$	V
T_{BIAS}	Temperature Under Bias	-55 to +125	°C
T_{STG}	Storage Temperature	-65 to +150	°C
I_{OUT}	Output Current	5	mA

Note: Stress greater than those listed under Absolute Maximum Ratings may cause permanent damage to the device. This is a stress rating only and functional operation of the device at these or any other condition outside those indicated in the operational sections of this specification is not implied. Exposure to absolute maximum rating conditions for extended periods may affect reliability.

6.2 Operating Range

Range	Ambient Temperature (T_A)	V_{CC}
Industrial	-40°C to +85°C	1.8V to 5.5V

Note: Giantec offers Industrial grade for Commercial applications (0°C to +70°C).

6.3 Capacitance

Symbol	Parameter ^[1, 2]	Conditions	Max.	Unit
C_{IN}	Input Capacitance	$V_{IN} = 0V$	6	pF
$C_{I/O}$	Input / Output Capacitance	$V_{I/O} = 0V$	8	pF

Notes: ^[1] Tested initially and after any design or process changes that may affect these parameters and not 100% tested.

^[2] Test conditions: $T_A = 25^\circ C$, $f = 1\text{ MHz}$, $V_{CC} = 5.0V$



GT25C128

6.4 DC Electrical Characteristic

Industrial: $T_A = -40^{\circ}\text{C}$ to $+85^{\circ}\text{C}$, $V_{CC} = 1.8\text{V} \sim 5.5\text{V}$

Symbol	Parameter	V _{CC}	Test Conditions	Min.	Max.	Unit
V _{CC}	Supply Voltage			1.8	5.5	V
V _{IH}	Input High Voltage			0.7* V _{CC}	V _{CC} +1	V
V _{IL}	Input Low Voltage			-0.3	0.3* V _{CC}	V
I _{LI}	Input Leakage Current		V _{IN} = 0V To V _{CC}	-2	2	μA
I _{LO}	Output Leakage Current		V _{OUT} = 0V To V _{CC} , $\overline{\text{CS}} = V_{CC}$	-2	2	μA
V _{OH1}	Output High Voltage	1.8	I _{OH} = -0.1mA	0.8*V _{CC}	—	V
		2.5	I _{OH} = -0.4mA	0.8*V _{CC}	—	V
		5	I _{OH} = -2 mA	0.8*V _{CC}	—	V
V _{OL1}	Output Low Voltage	1.8	I _{OL} = 0.15 mA	—	0.2	V
		2.5	I _{OL} = 1.5 mA	—	0.4	V
		5	I _{OL} = 2 mA	—	0.4	V
I _{CC}	Operating Current	1.8	Read/Write at 2 MHz, SO=Open	—	3	mA
		2.5	Read/Write at 2 MHz, SO=Open	—	4	mA
		5	Read/Write at 5 MHz, SO=Open	—	10	mA
I _{SB}	Standby Current	1.8	V _{IN} = V _{CC} or GND, $\overline{\text{CS}} = V_{CC}$	—	15	μA
		2.5	V _{IN} = V _{CC} or GND, $\overline{\text{CS}} = V_{CC}$	—	20	μA
		5	V _{IN} = V _{CC} or GND, $\overline{\text{CS}} = V_{CC}$	—	25	μA



GT25C128

6.5 AC Electrical Characteristic

Industrial: $T_A = -40^{\circ}\text{C}$ to $+85^{\circ}\text{C}$, Supply voltage = 1.8V to 5.5V

Symbol	Parameter ^[1]	1.8V ≤ V _{CC} < 2.5V		2.5V ≤ V _{CC} < 4.5V		4.5V ≤ V _{CC} ≤ 5.5V		Unit
		Min.	Max.	Min.	Max.	Min.	Max.	
F _{SCK}	SCK Clock Frequency	0	2	0	2	0	5	MHz
T _{RI}	Input Rise Time	—	1	—	1	—	1	μs
T _{FI}	Input Fall Time	—	1	—	1	—	1	μs
T _{WH}	SCK High Time	200	—	200	—	100	—	ns
T _{WL}	SCK Low Time	200	—	200	—	100	—	ns
T _{CS}	$\overline{\text{CS}}$ High Time	200	—	200	—	100	—	ns
T _{CSS}	$\overline{\text{CS}}$ Setup Time	200	—	200	—	100	—	ns
T _{CSH}	$\overline{\text{CS}}$ Hold Time	200	—	200	—	100	—	ns
T _{SU}	Data In Setup Time	40	—	40	—	20	—	ns
T _H	Data In Hold Time	50	—	50	—	30	—	ns
T _{HD}	$\overline{\text{HOLD}}$ Setup Time	100	—	100	—	50	—	ns
T _{CD}	$\overline{\text{HOLD}}$ Hold Time	100	—	100	—	50	—	ns
T _V ^[2]	Output Valid	0	150	0	100	0	50	ns
T _{HO}	Output Hold Time	0	—	0	—	0	—	ns
T _{LZ}	$\overline{\text{HOLD}}$ to Output Low Z	0	100	0	100	0	50	ns
T _{HZ}	$\overline{\text{HOLD}}$ to Output High Z	—	200	—	200	—	100	ns
T _{DIS}	Output Disable Time	—	200	—	200	—	100	ns
T _{WC}	Write Cycle Time	—	5	—	5	—	5	ms

Notes: ^[1] The parameters are characterized but not 100% tested.

^[2] C_L = 30pF (typical)



GT25C128

7. Ordering Information

Industrial Grade: -40°C to +85°C, Lead-free

Voltage Range	Part Number*	Package (8-pin)*
1.8V to 5.5V	GT25C128-2GLI-TR	150-mil SOIC
	GT25C128-2ZLI-TR	3 x 4.4 mm TSSOP

*

1. Contact Giantec Sales Representatives for availability and other package information.
2. The product is packed in tape and reel "-TR" (4K per reel), except UDFN is 5K per reel.
3. Refer to Giantec website for related declaration document on lead free, RoHS, halogen free or Green, whichever is applicable.
4. Giantec offers Industrial grade for Commercial applications (0°C to +70°C).



GT25C128

8. Top Markings

8.1 SOIC Package

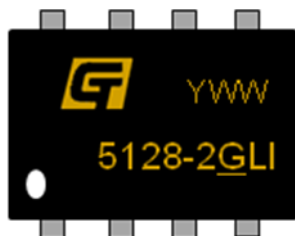

G: Giantec Logo

5128-2GLI: GT25C128-2GLI-TR

YWW: Date Code, Y=year, WW=week

8.2 TSSOP Package



GT: Giantec Logo

5128-2ZLI: GT25C128-2ZLI-TR

YWW: Date Code, Y=year, WW=week



GT25C128

9. Package Information

9.1 SOIC

8L 150mil SOIC Package Outline

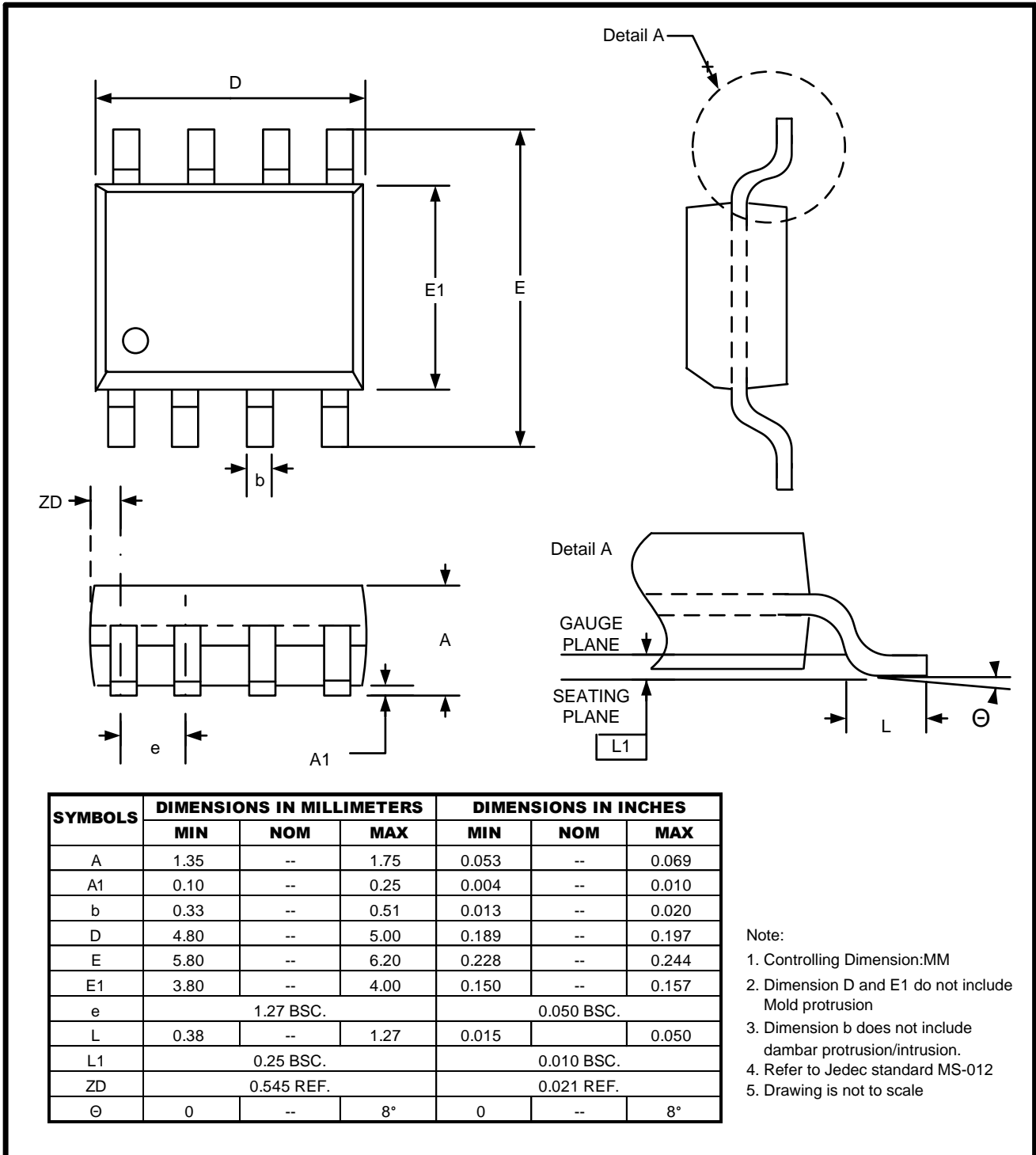



GT25C128

9.2 TSSOP

8L 3x4.4mm TSSOP Package Outline

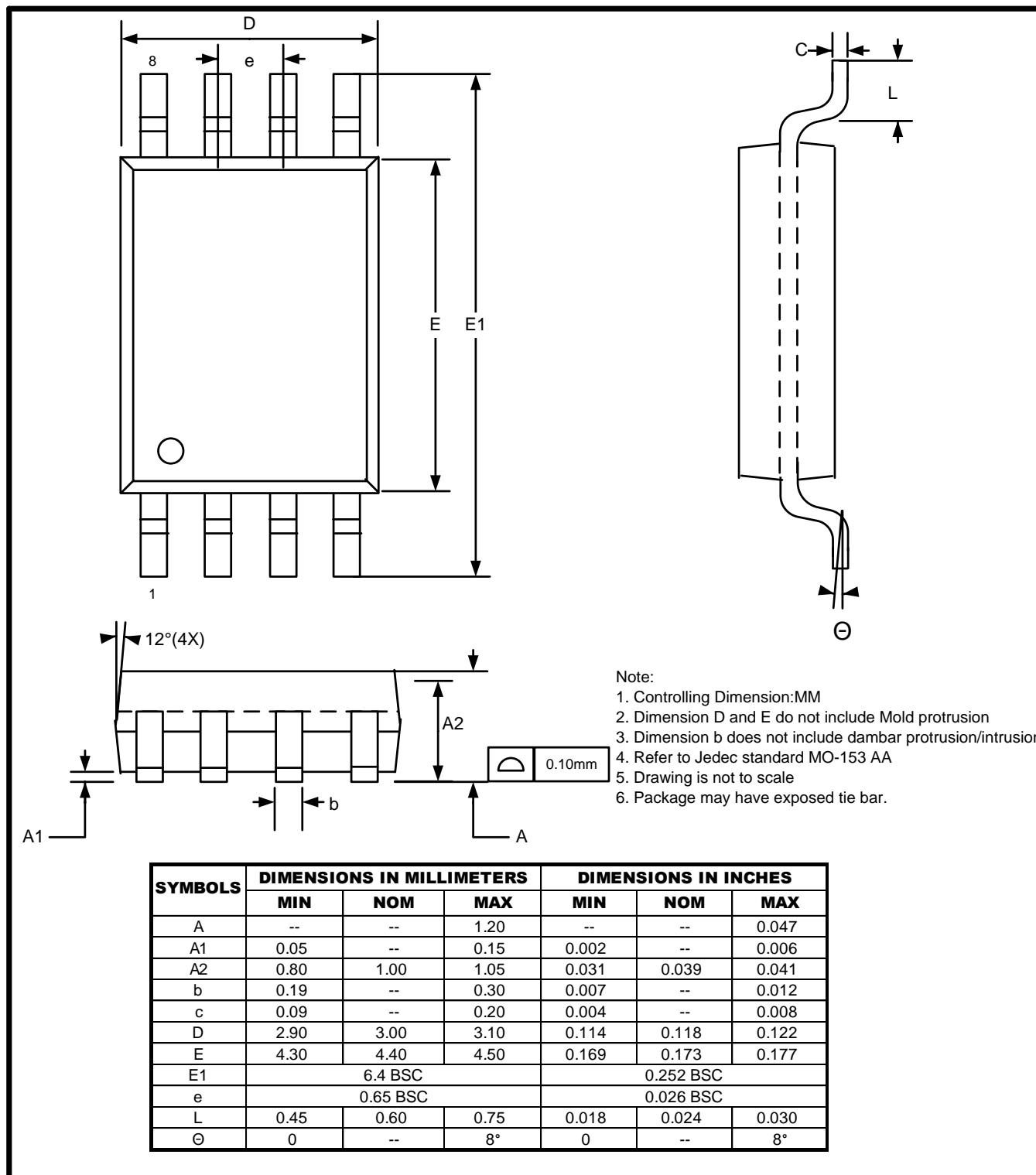



GT25C128

10. Revision History

Revision	Date	Descriptions
A0	Mar. 2010	Initial version
A1	Jun. 2011	New datasheet format
C2	Oct. 2013	Revise SOIC/SOP to SOIC