

## Harvatek Surface Mount CHIP LEDs Data Sheet B2141IR--A1C000373U1373

Official Product	HT Part No. B2141IR--A1C000373U1373		
Tentative Product	*****	*****	*****
Specifications are subject to changes for improvement without advance notice. Proprietary data, drawings, company confidential all rights reserved.		02/24/2020	Version 1.1 Page 1/14

**DISCLAIMER.....3**

**LIFE SUPPORT POLICY.....3**

**PRODUCT SPECIFICATIONS .....4**

**ATTENTION: ELECTROSTATIC DISCHARGE (ESD) PROTECTION .....4**

**LABEL SPECIFICATIONS .....5**

**ELECTRO-OPTICAL CHARACTERISTICS.....6**

**PACKAGE OUTLINE DIMENSION AND RECOMMENDED SOLDERING PATTERN FOR REFLOW**

**SOLDERING.....7**

**CHARACTERISTICS OF B2141IR .....8**

**PACKAGING .....10**

**TAPE DIMENSION .....10**

**REEL DIMENSION.....11**

**PACKING.....11**

**DRY PACK.....12**

**BAKING.....12**

**PRECAUTIONS .....12**

**REFLOW SOLDERING .....13**

**REWORKING.....13**

**CLEANING.....13**

**CAUTIONS OF PICK AND PLACE .....14**

**REVISE HISTORY.....14**

Official Product	HT Part No. B2141IR--A1C000373U1373		
Tentative Product	*****	*****	
Specifications are subject to changes for improvement without advance notice. Proprietary data, drawings, company confidential all rights reserved.		02/24/2020	Version 1.1 Page 2/14

## DISCLAIMER

HARVATEK reserves the right to make changes without further notice to any products herein to improve reliability, function or design. HARVATEK does not assume any liability arising out of the application or use of any product or circuit described herein; neither does it convey any license under its patent rights, nor the rights of others.

## Life Support Policy

HARVATEK's products are not authorized for use as critical components in life support devices or systems without the express written approval of the President of HARVATEK or HARVATEK INTERNATIONAL. As used herein:

1. Life support devices or systems are devices or systems which, (a) are intended for surgical implant into the body, or (b) support or sustain life, and (c) whose failure to perform when properly used in accordance with instructions for use provided in the labeling, can be reasonably expected to result in a significant injury of the user.
2. A critical component in any component of a life support device or system whose failure to perform can be reasonably expected to cause the failure of the life support device or system, or to affect its safety or effectiveness.

Official Product	HT Part No. B21411R--A1C000373U1373		
Tentative Product	*****	*****	
Specifications are subject to changes for improvement without advance notice. Proprietary data, drawings, company confidential all rights reserved.		02/24/2020	Version 1.1 Page 3/14

## Product Specifications

Item	Specification	Material	Quantity
Peak Wavelength $\lambda_p$	Typ:940nm @100 mA/ $T_s = 25^\circ\text{C}$		
Radiant Intensity $I_e$	30-60 mW/sr @100 mA/ $T_s = 25^\circ\text{C}$		
Forward Voltage $V_F$	1.2-1.6V @100 mA/ $T_s = 25^\circ\text{C}$ ; Tolerance: $\pm 0.1\text{V}$		
Reverse Current $I_R$	< 10 $\mu\text{A}$ @ $V_R = 5\text{V}$		
Resin	Clear	Epoxy	
Carrier tape	EIA 481-1A specs	Conductive black tape	
Reel	EIA 481-1A specs	Conductive black	
Label	HT standard	Paper	
Packing bag	220x240mm	Aluminum laminated bag/ no-zipper	One reel per bag
Carton	HT standard	Paper	Non-specified

### Others:

Each immediate box consists of 5 reels. The 5 reels may not necessarily have the same lot number or the same bin combinations of  $I_v$ ,  $\lambda_P$  and  $V_f$ . Each reel has a label identifying its specification; the immediate box consists of a product label as well.

Note :This is shipped test conditions

※Remarks: This product should be operated in forward bias. If a reverse voltage is continuously applied to the product, such operation can cause migration resulting in LED damage.

### ATTENTION: Electrostatic Discharge (ESD) protection



The symbol to the left denotes that ESD precaution is needed. ESD protection for GaP and AlGaAs based chips is necessary even though they are relatively safe in the presence of low static-electric discharge. Parts built with AlInGaP, GaN, or/and InGaN based chips are **STATIC SENSITIVE devices**. ESD precaution must be taken during design and assembly.

If manual work or processing is needed, please ensure the device is adequately protected from ESD during the process.

Official Product	HT Part No. B21411R--A1C000373U1373		
Tentative Product	*****	*****	
Specifications are subject to changes for improvement without advance notice. Proprietary data, drawings, company confidential all rights reserved.	02/24/2020	Version 1.1	Page 4/14

## Label Specifications



### ■Harvatek P/N:

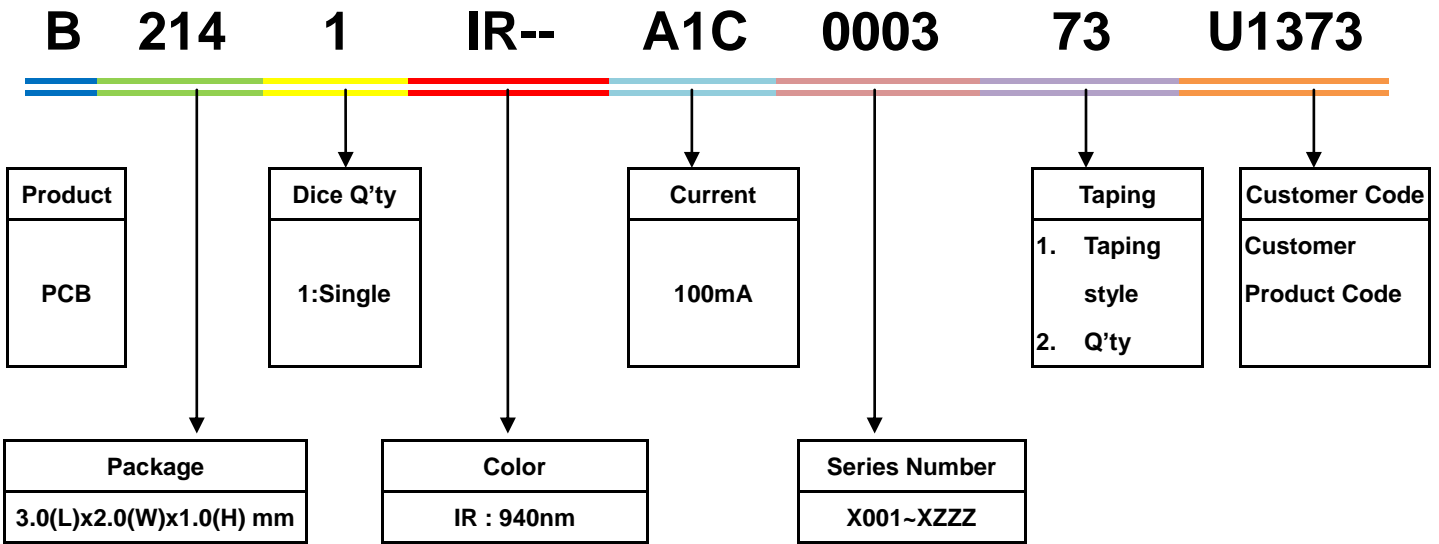

### ■ Lot No.:

1	2	3	4	5	6	7	8	9	10
E	1	A	1	A	2	2	L	1	2
Code 1 2		Code 3	Code 4	Code 5	Code 6	Code 7	Code 8	Code 9	Code 10
		Mfg. Year	Mfg. Month	Mfg. Date	Consecutive number		Special code		
Internal Tracing Code		2010-A		1:A	01~ZZ		000~ZZZ		
		2011-B		2:B					
		2012-C	1:Jan.	3:C					
		...	2:Feb.	...					
		2018-I/J	...	26:Z					
		2019-K	A:Oct.	27:7					
		...	B:Nov.	28:8					
2022-N	C:Dec.	29:9							
2023-P		30:3							
...		31:4							

Official Product	HT Part No. B21411R--A1C000373U1373		
Tentative Product	*****	*****	
Specifications are subject to changes for improvement without advance notice. Proprietary data, drawings, company confidential all rights reserved.		02/24/2020	Version 1.1 Page 5/14

## Absolute Maximum Rating At 25°C

Symbol	Parameters	Ratings	Units	Notes
$I_F$	Forward Current	150	mA	
$I_{FP}$	Peak Forward Current	1	A	1
$V_R$	Reverse Voltage	5	V	
$T_{opr}$	Operating Temperature	-40 ~ +85	°C	
$T_{stg}$	Storage Temperature	-40 ~ +100	°C	
$T_{sol}$	Soldering Temperature	260	°C	2

### Notes:

- $I_{FP}$  Conditions--Pulse Width  $\leq 100\mu s$  and Duty  $\leq 1\%$ .
- Soldering time  $\leq 5$  seconds.

## Electro-Optical Characteristics

Symbol	Parameters	Test conditions	Min	Typ	Max	Units	Notes
$I_e$	Radiant Intensity	$I_F=100mA$	30	43	60	mW/sr	3
$\lambda_P$	Peak Wavelength	$I_F=100mA$	-	940	-	nm	4
$\Delta\lambda$	Spectral bandwidth at 50% of $I_{max}$	$I_F=100mA$		50	-	nm	
$V_F$	Forward Voltage	$I_F=100mA$	1.2	-	1.6	V	5
$I_R$	Reverse Current	$V_R=5V$	-	-	10	$\mu A$	
$2\theta_{1/2}$	Angle of Half Intensity (X)	$I_F=100mA$	-	140	-	deg	
	Angle of Half Intensity (Y)		-	120	-		

### Notes:

- Radiant Intensity ( $I_e$ ) Bin:

Color	Bin Code	Spec. Range
IR	PRU	30-40 mW/sr
	PVY	40-50 mW/sr
	PZC	50-60 mW/sr

- Peak Wavelength ( $\lambda_P$ ) Bin:

Color	Bin Code	Spec. Range
IR	B	920-960 nm

Official Product	HT Part No. B21411R--A1C000373U1373		
Tentative Product	*****	*****	
Specifications are subject to changes for improvement without advance notice. Proprietary data, drawings, company confidential all rights reserved.		02/24/2020	Version 1.1 Page 6/14

**Notes:**

5. Forward Voltage ( $V_F$ ) Bin:

Color	Bin Code	Spec. Range
IR	D5	1.2-1.4 V
	D6	1.4-1.6 V

**Package Outline Dimension and Recommended Soldering Pattern for Reflow Soldering**

(Unit: mm Tolerance: +/-0.1)

Outline Dim.	Soldering Pattern
<p>Soldering terminals may shift in the x, y direction.</p>	

Official Product	HT Part No. B21411R--A1C000373U1373		
Tentative Product	*****	*****	*****
Specifications are subject to changes for improvement without advance notice. Proprietary data, drawings, company confidential all rights reserved.		02/24/2020	Version 1.1
		Page 7/14	

## Characteristics of B21411R

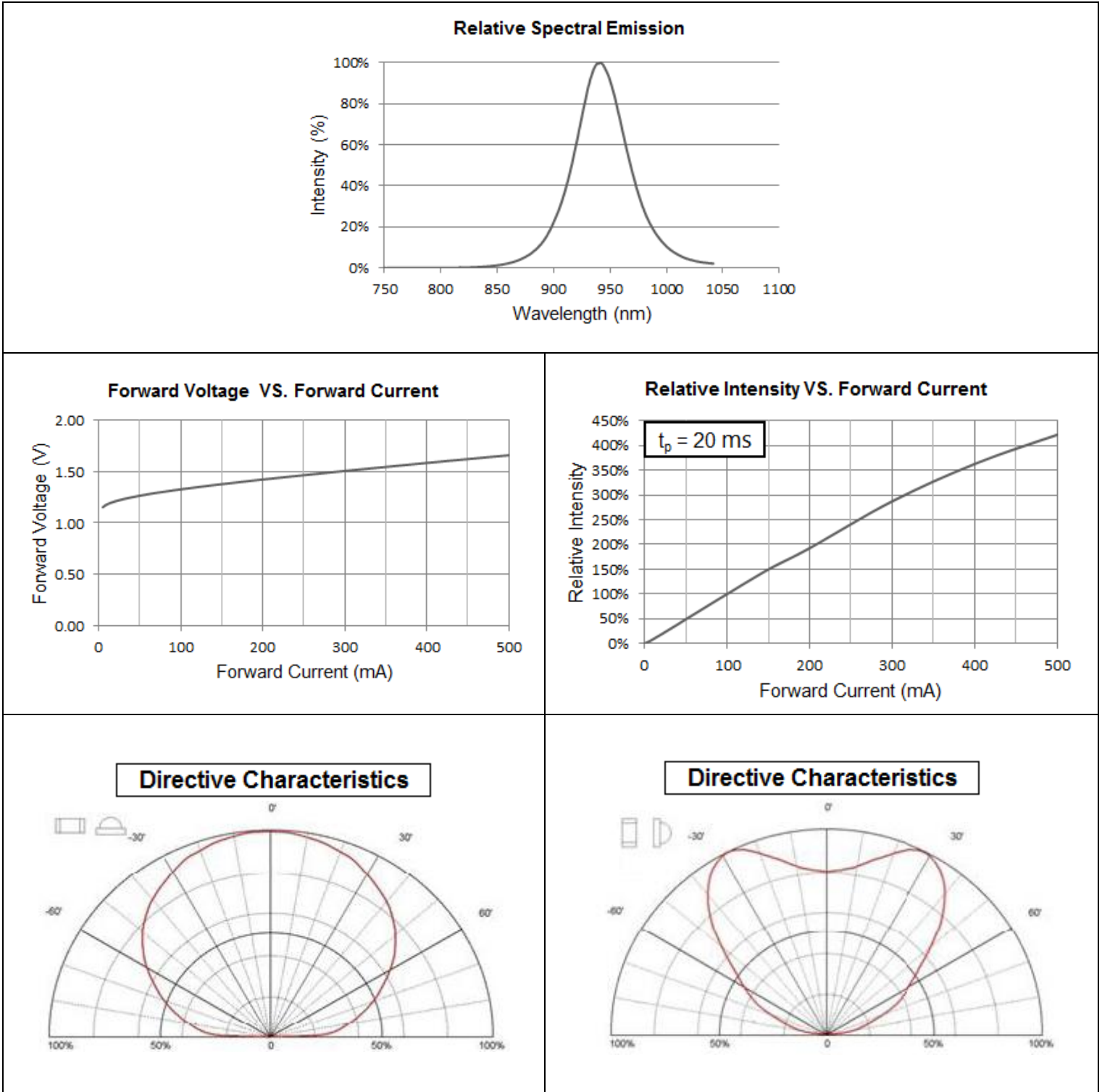

Official Product	HT Part No. B21411R--A1C000373U1373		
Tentative Product	*****	*****	*****
Specifications are subject to changes for improvement without advance notice. Proprietary data, drawings, company confidential all rights reserved.		02/24/2020	Version 1.1 Page 8/14



## Precaution for Use

1. The chips should not be used directly in any type of fluid such as water, oil, organic solvent, etc.
2. When the LEDs are illuminating, the maximum ambient temperature should be first considered before operation.
3. LEDs must be stored in a clean environment. A sealed container with a nitrogen atmosphere is necessary if the storage period is over 3 months after shipping.
4. The LEDs must be used within 4 weeks after unpacked. Unused products must be repacked in an anti-electrostatic package, folded to close any opening and then stored in a dry and cool space.
5. The appearance and specifications of the products may be modified for improvement without further notice.
6. The LEDs are sensitive to the static electricity and surge. It is strongly recommended to use a grounded wrist band and anti-electrostatic glove when handling the LEDs. If a voltage over the absolute maximum rating is applied to LEDs, it will damage LEDs. Damaged LEDs will show some abnormal characteristics such as remarkable increase of leak current, lower turn-on voltage and getting unlit at low current.

Official Product	HT Part No. B21411R--A1C000373U1373		
Tentative Product	*****	*****	
Specifications are subject to changes for improvement without advance notice. Proprietary data, drawings, company confidential all rights reserved.		02/24/2020	Version 1.1 Page 9/14

## Packaging Tape Dimension

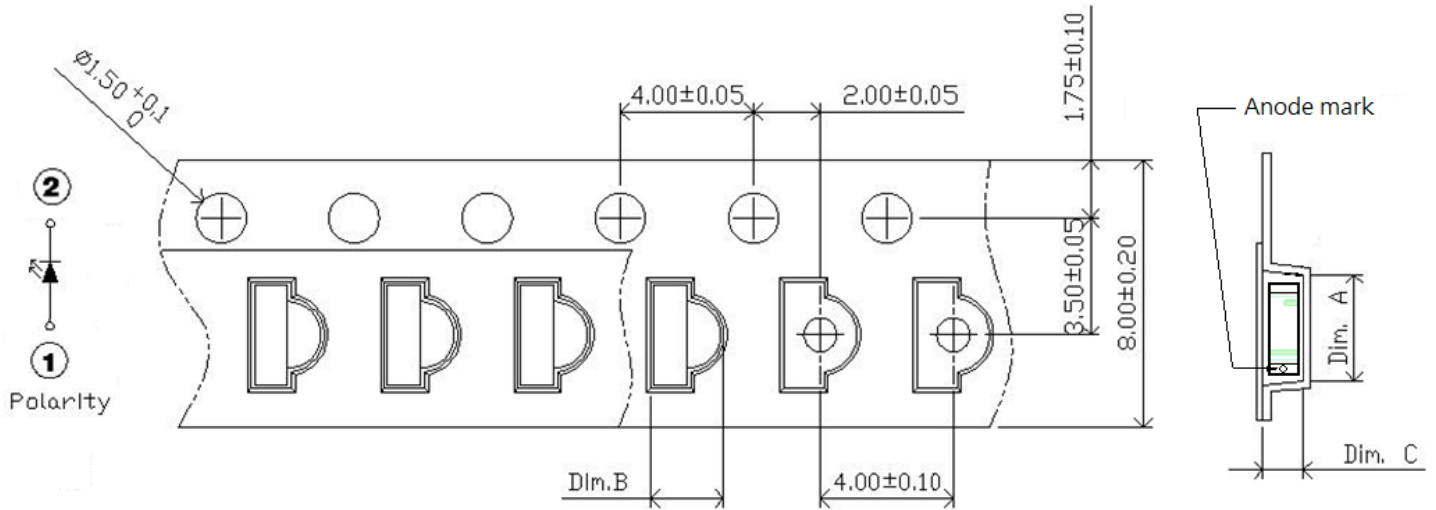

Dim. A	Dim. B	Dim. C	Q'ty/Reel
3.2±0.10	2.20±0.10	1.20±0.10	3K

Unit: mm

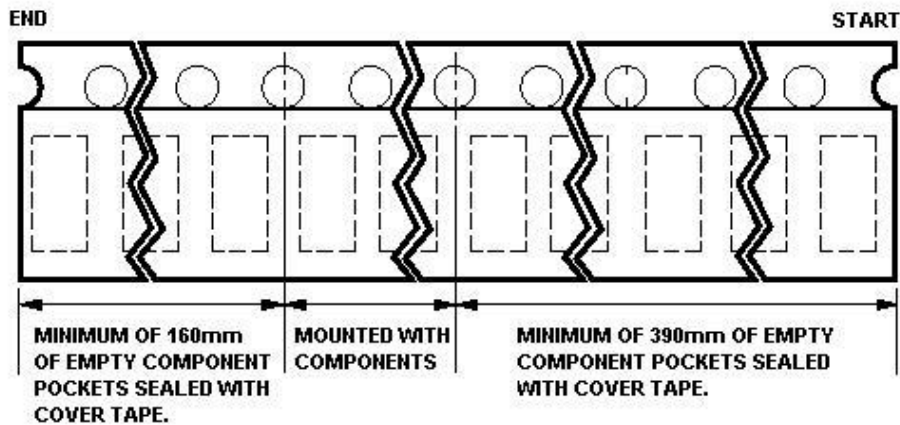

Official Product	HT Part No. B21411R--A1C000373U1373		
Tentative Product	*****	*****	*****
Specifications are subject to changes for improvement without advance notice. Proprietary data, drawings, company confidential all rights reserved.	02/24/2020	Version 1.1	Page 10/14

## Reel Dimension

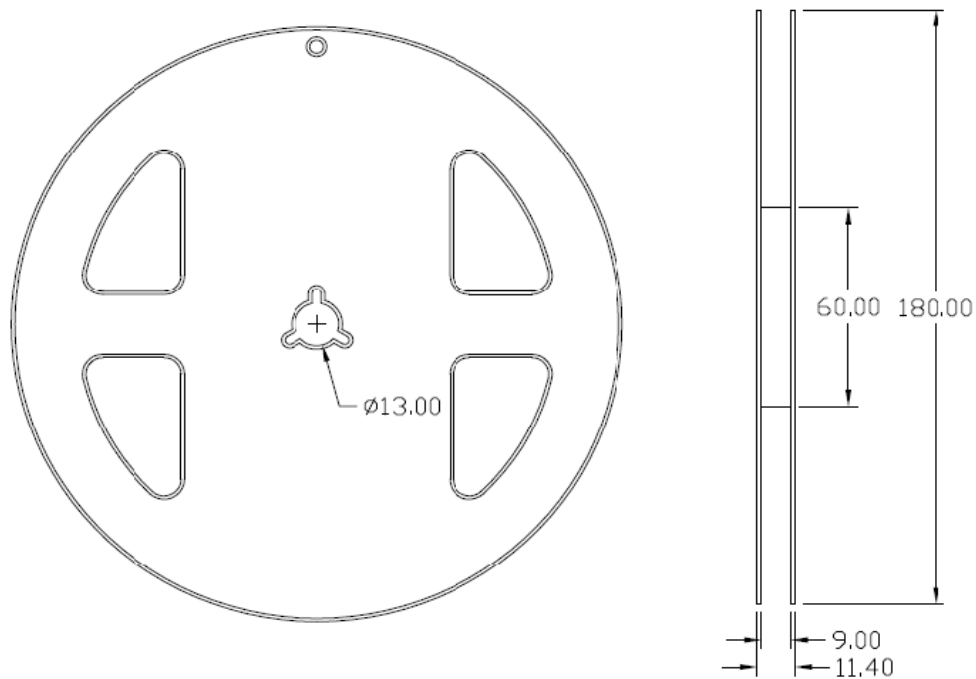

## Packing

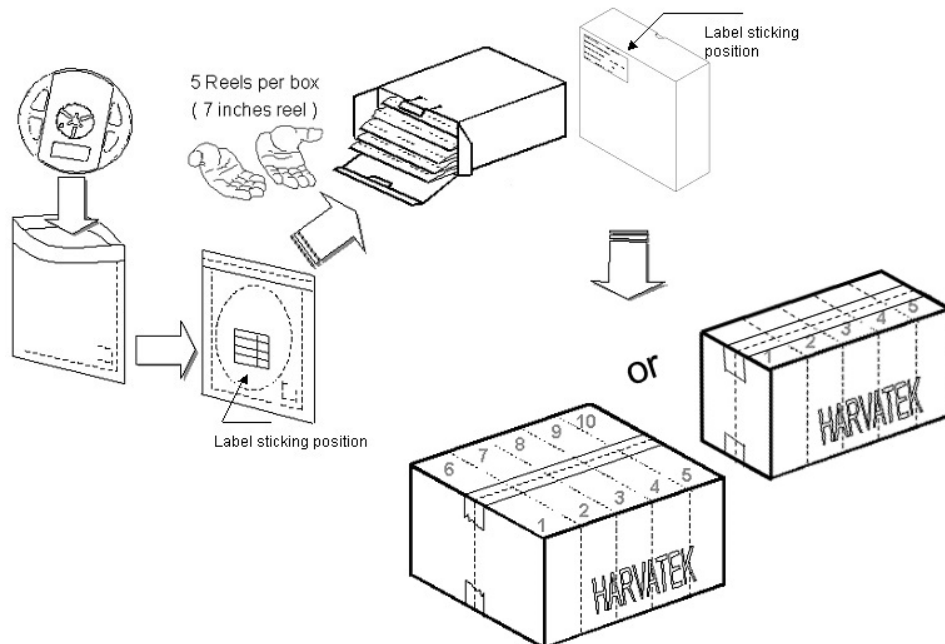

5 or 10 boxes per carton is available depending on shipment quantity.

Official Product	HT Part No. B21411R--A1C000373U1373		
Tentative Product	*****	*****	*****
Specifications are subject to changes for improvement without advance notice. Proprietary data, drawings, company confidential all rights reserved.		02/24/2020	Version 1.1 Page 11/14

## Dry Pack

All SMD optical devices are **MOISTURE SENSITIVE**. Avoid exposure to moisture at all times during transportation or storage. Every reel is packaged in a moisture protected anti-static bag. Each bag is properly sealed prior to shipment.

A humidity indicator will be included in the moisture protected anti-static bag prior to shipment.

The packaging sequence is as follows:



## Baking

Baking before soldering is recommended when the package has been unsealed for 4 weeks.

The conditions are as followings:

1.  $60\pm 3^{\circ}\text{C} \times (12\sim 24\text{hrs})$  and  $<5\% \text{RH}$ , taped reel type.
2.  $100\pm 3^{\circ}\text{C} \times (45\text{min}\sim 1\text{hr})$ , bulk type.
3.  $130\pm 3^{\circ}\text{C} \times (15\text{min}\sim 30\text{min})$ , bulk type.

## Precautions

1. Avoid exposure to moisture at all times during transportation or storage.
2. Anti-Static precaution must be taken when handling GaN, InGaN, and AlInGaP products.
3. It is suggested to connect the unit with a current limiting resistor of the proper size. Avoid applying a reverse voltage beyond the specified limit.
4. Avoid operation beyond the limits as specified by the absolute maximum ratings.
5. Avoid direct contact with the surface through which the LED emits light.
6. If possible, assemble the unit in a clean room or dust-free environment.

Official Product	HT Part No. B21411R--A1C000373U1373		
Tentative Product	*****	*****	*****
Specifications are subject to changes for improvement without advance notice. Proprietary data, drawings, company confidential all rights reserved.		02/24/2020	Version 1.1 Page 12/14

## Reflow Soldering

Recommend soldering paste specifications:

1. Operating temp.: Above 220°C ,60sec
2. Peak temp.:260°C Max.,10sec Max.
3. Reflow soldering should not be done more than two times.
4. Never take next process until the component is cooled down to room temperature after reflow.
5. The recommended reflow soldering profile (measuring on the surface of the LED terminal) is following:

Lead-free Solder Profile

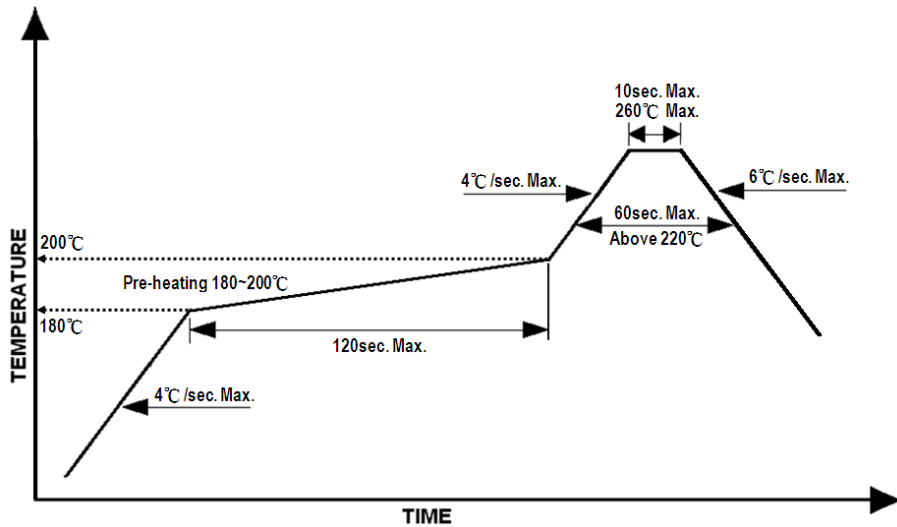

## Reworking

- Rework should be completed within 5 seconds under 260°C.
- The iron tip must not come in contact with the copper foil.
- Twin-head type is preferred.

## Cleaning

Following are cleaning procedures after soldering:

- An alcohol-based solvent such as isopropyl alcohol (IPA) is recommended.
- Temperature x Time should be 50°C x 30sec. or <30°C x 3min
- Ultra sonic cleaning: < 15W/ bath; bath volume ≤ 1liter
- Curing: 100°C max, <3min

Official Product	HT Part No. B21411R--A1C000373U1373			
Tentative Product	*****	*****	*****	*****
Specifications are subject to changes for improvement without advance notice. Proprietary data, drawings, company confidential all rights reserved.		02/24/2020	Version 1.1	Page 13/14

## Cautions of Pick and Place

- Avoid stress on the resin at elevated temperature.
- Avoid rubbing or scraping the resin by any object.
- Electric-static may cause damage to the component. Please ensure that the equipment is properly grounded. Use of an ionizer fan is recommended.

## Revise History

Rev.	Descriptions	Date	Page
1.0	-	06/20/2019	-
1.1	New Lot No.	02/24/2020	5

Official Product	HT Part No. B21411R--A1C000373U1373		
Tentative Product	*****	*****	*****
Specifications are subject to changes for improvement without advance notice. Proprietary data, drawings, company confidential all rights reserved.		02/24/2020	Version 1.1 Page 14/14