

**REPETITIVE AVALANCHE AND dv/dt RATED  
 HEXFET<sup>®</sup> TRANSISTORS  
 THRU-HOLE - TO-205AF (TO-39)**

**IRFF9120  
 JANTX2N6845  
 JANTXV2N6845  
 REF:MIL-PRF-19500/563  
 100V, P-CHANNEL**

**Product Summary**

Part Number	BVDSS	RDS(on)	ID
IRFF9120	-100V	0.60Ω	-4.0A



The HEXFET<sup>®</sup> technology is the key to International Rectifier's advanced line of power MOSFET transistors. The efficient geometry and unique processing of this latest "State of the Art" design achieves: very low on-state resistance combined with high transconductance. The HEXFET transistors also feature all of the well established advantages of MOSFETs such as voltage control, very fast switching, ease of paralleling and temperature stability of the electrical parameters. They are well suited for applications such as switching power supplies, motor controls, inverters, choppers, audio amplifiers and high energy pulse circuits.

**Features:**

- Repetitive Avalanche Ratings
- Dynamic dv/dt Rating
- Hermetically Sealed
- Simple Drive Requirements
- Ease of Paralleling
- ESD Rating: Class 1B per MIL-STD-750, Method 1020

**Absolute Maximum Ratings**

	Parameter		Units
ID @ VGS = -10V, TC = 25°C	Continuous Drain Current	-4.0	A
ID @ VGS = -10V, TC = 100°C	Continuous Drain Current	-2.6	
IDM	Pulsed Drain Current ①	-16	
PD @ TC = 25°C	Max. Power Dissipation	20	W
	Linear Derating Factor	0.16	W/°C
VGS	Gate-to-Source Voltage	±20	V
EAS	Single Pulse Avalanche Energy ②	364	mJ
IAR	Avalanche Current ①	-4.0	A
EAR	Repetitive Avalanche Energy ①	2.0	mJ
dv/dt	Peak Diode Recovery dv/dt ③	-5.0	V/ns
TJ	Operating Junction	-55 to 150	°C
TSTG	Storage Temperature Range		
	Lead Temperature	300 (0.063 in. (1.6mm) from case for 10s)	
	Weight	0.98(typical)	g

For footnotes refer to the last page

**Electrical Characteristics @ T<sub>j</sub> = 25°C (Unless Otherwise Specified)**

	Parameter	Min	Typ	Max	Units	Test Conditions
B <sub>V</sub> DSS	Drain-to-Source Breakdown Voltage	-100	—	—	V	V <sub>GS</sub> = 0V, I <sub>D</sub> = -1.0mA
ΔB <sub>V</sub> DSS/ΔT <sub>J</sub>	Temperature Coefficient of Breakdown Voltage	—	-0.10	—	V/°C	Reference to 25°C, I <sub>D</sub> = -1.0mA
R <sub>DS(on)</sub>	Static Drain-to-Source On-State Resistance	—	—	0.60	Ω	V <sub>GS</sub> = -10V, I <sub>D</sub> = -2.6A ④
		—	—	0.69		V <sub>GS</sub> = -10V, I <sub>D</sub> = -4.0A ④
V <sub>GS(th)</sub>	Gate Threshold Voltage	-2.0	—	-4.0	V	V <sub>DS</sub> = V <sub>GS</sub> , I <sub>D</sub> = -250μA
g <sub>fs</sub>	Forward Transconductance	1.25	—	—	S	V <sub>DS</sub> = -15V, I <sub>DS</sub> = -2.6A ④
I <sub>DSS</sub>	Zero Gate Voltage Drain Current	—	—	-25	μA	V <sub>DS</sub> = -80V, V <sub>GS</sub> = 0V
		—	—	-250		V <sub>DS</sub> = -80V V <sub>GS</sub> = 0V, T <sub>J</sub> = 125°C
I <sub>GSS</sub>	Gate-to-Source Leakage Forward	—	—	-100	nA	V <sub>GS</sub> = -20V
I <sub>GSS</sub>	Gate-to-Source Leakage Reverse	—	—	100		V <sub>GS</sub> = 20V
Q <sub>g</sub>	Total Gate Charge	4.3	—	16.3	nC	V <sub>GS</sub> = -10V, I <sub>D</sub> = -4.0A
Q <sub>gs</sub>	Gate-to-Source Charge	1.3	—	4.7		V <sub>DS</sub> = -50V
Q <sub>gd</sub>	Gate-to-Drain ('Miller') Charge	1.0	—	9.0		
t <sub>d(on)</sub>	Turn-On Delay Time	—	—	60	ns	V <sub>DD</sub> = -50V, I <sub>D</sub> = -4.0A, V <sub>GS</sub> = -10V, R <sub>G</sub> = 7.5Ω
t <sub>r</sub>	Rise Time	—	—	100		
t <sub>d(off)</sub>	Turn-Off Delay Time	—	—	50		
t <sub>f</sub>	Fall Time	—	—	70		
LS + LD	Total Inductance	—	7.0	—	nH	Measured from drain lead (6mm/0.25in. from package) to source lead (6mm/0.25in. from package)
C <sub>iss</sub>	Input Capacitance	—	380	—	pF	V <sub>GS</sub> = 0V, V <sub>DS</sub> = -25V f = 1.0MHz
C <sub>oss</sub>	Output Capacitance	—	170	—		
C <sub>rss</sub>	Reverse Transfer Capacitance	—	45	—		

**Source-Drain Diode Ratings and Characteristics**

	Parameter	Min	Typ	Max	Units	Test Conditions
I <sub>S</sub>	Continuous Source Current (Body Diode)	—	—	-4.0	A	
I <sub>SM</sub>	Pulse Source Current (Body Diode) ①	—	—	-16		
V <sub>SD</sub>	Diode Forward Voltage	—	—	-4.8	V	T <sub>j</sub> = 25°C, I <sub>S</sub> = -4.0A, V <sub>GS</sub> = 0V ④
t <sub>rr</sub>	Reverse Recovery Time	—	—	200	ns	T <sub>j</sub> = 25°C, I <sub>F</sub> = -4.0A, di/dt ≤ -100A/μs
Q <sub>RR</sub>	Reverse Recovery Charge	—	—	3.1	μC	V <sub>DD</sub> ≤ -50V ④
t <sub>on</sub>	Forward Turn-On Time	Intrinsic turn-on time is negligible. Turn-on speed is substantially controlled by LS + LD.				

**Thermal Resistance**

	Parameter	Min	Typ	Max	Units	Test Conditions
R <sub>thJC</sub>	Junction-to-Case	—	—	6.25	°C/W	Typical socket mount
R <sub>thJA</sub>	Junction-to-Ambient	—	—	175		

Note: Corresponding Spice and Saber models are available on International Rectifier Website.

For footnotes refer to the last page

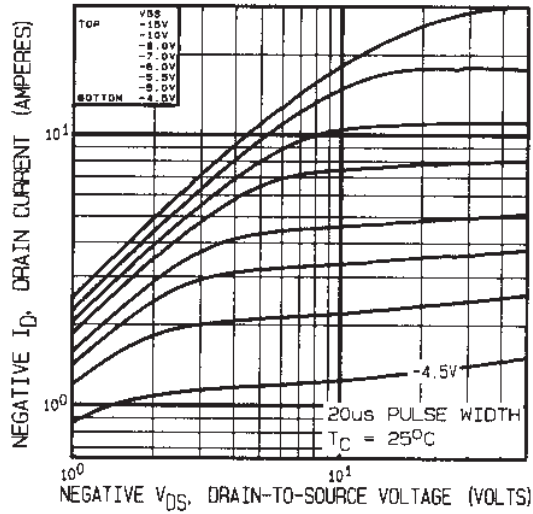

Fig1. Typical Output Characteristics

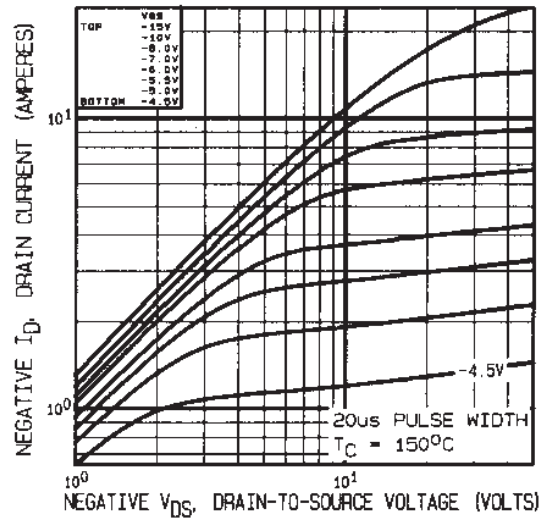

Fig2. Typical Output Characteristics

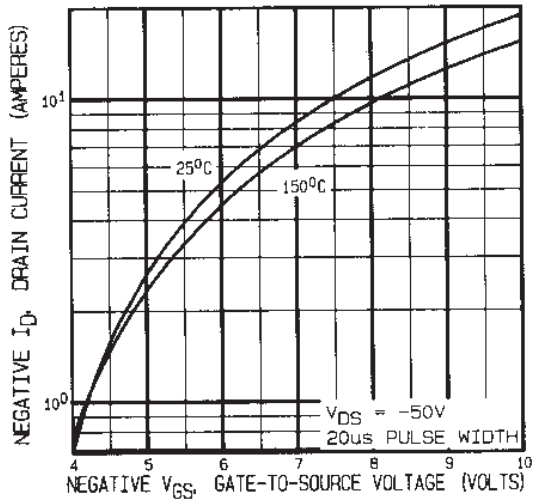

Fig3. Typical Transfer Characteristics

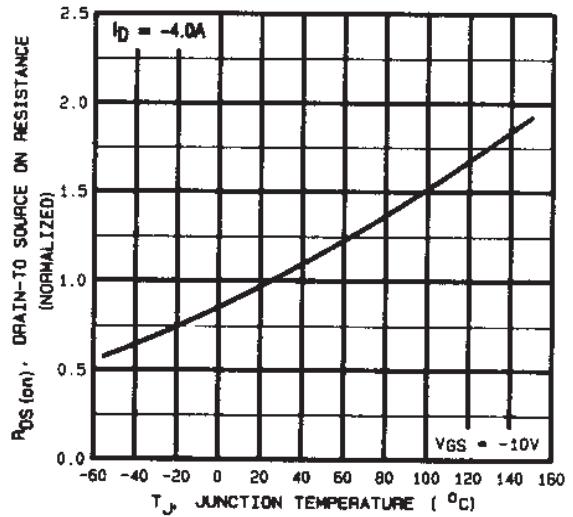
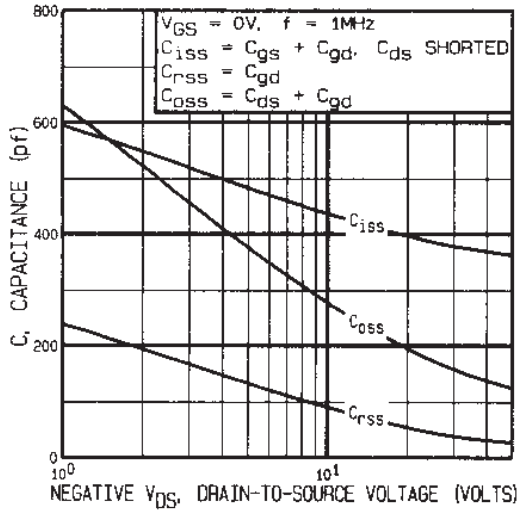
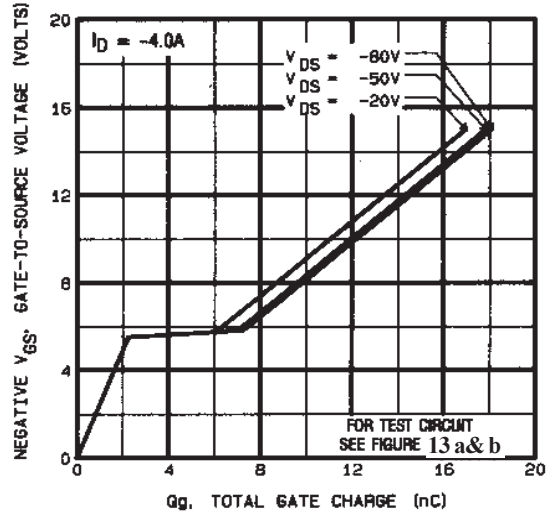

Fig4. Normalized On-Resistance Vs. Temperature



**Fig5.** Typical Capacitance Vs. Drain-to-Source Voltage



**Fig6.** Typical Gate Charge Vs. Gate-to-Source Voltage

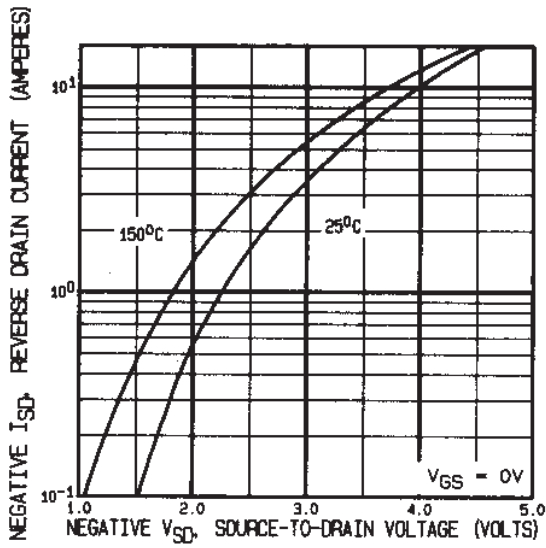

**Fig7.** Typical Source-Drain Diode Forward Voltage

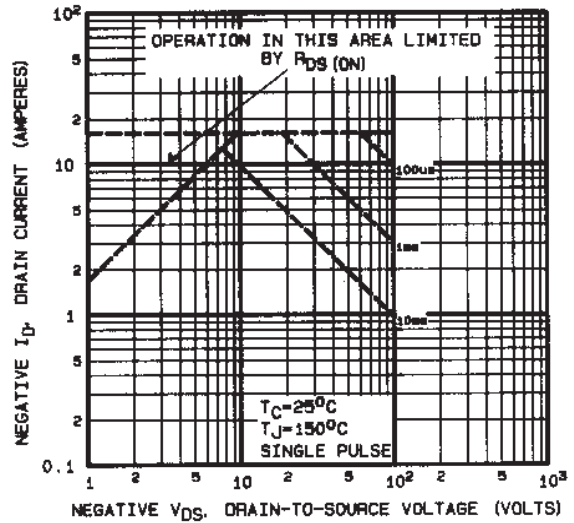

**Fig8.** Maximum Safe Operating Area

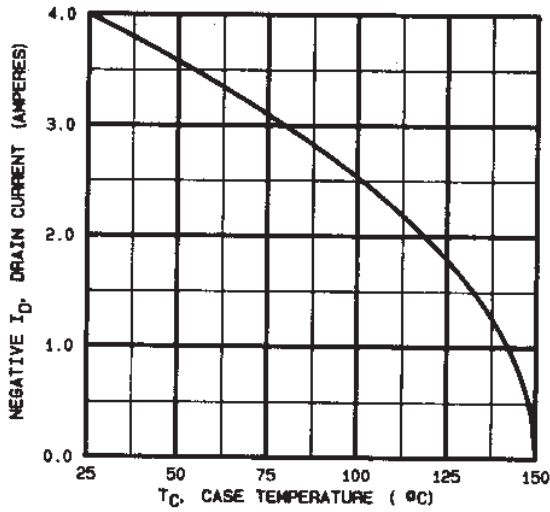

**Fig9.** Maximum Drain Current Vs. Case Temperature

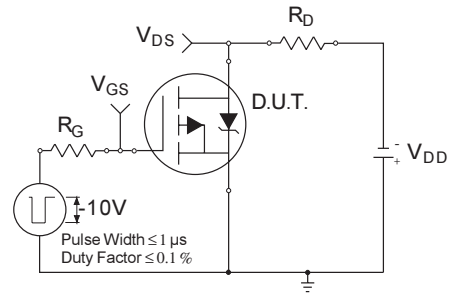

**Fig 10a.** Switching Time Test Circuit

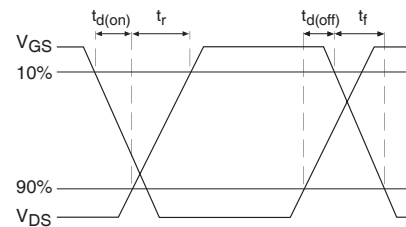

**Fig 10b.** Switching Time Waveforms

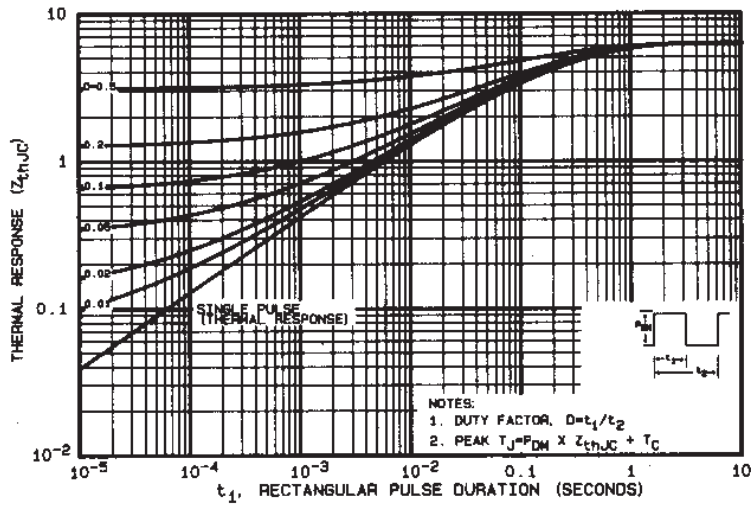

**Fig 11.** Maximum Effective Transient Thermal Impedance, Junction-to-Case

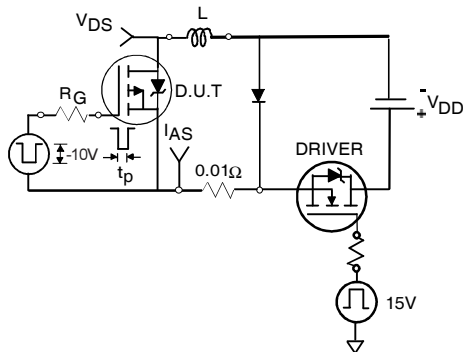

Fig 12a. Unclamped Inductive Test Circuit

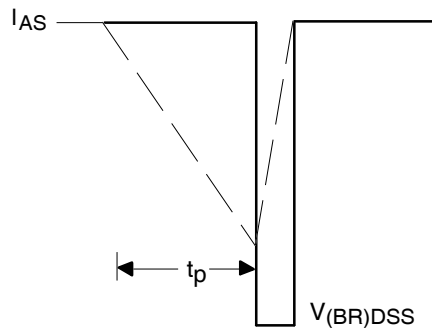

Fig 12b. Unclamped Inductive Waveforms

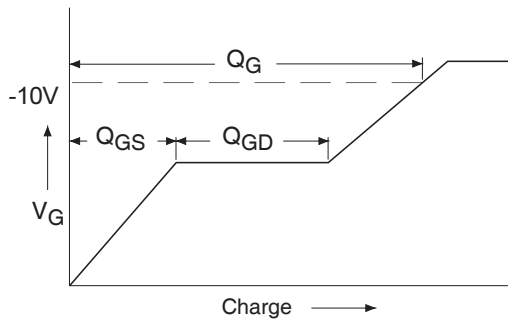

Fig 13a. Basic Gate Charge Waveform

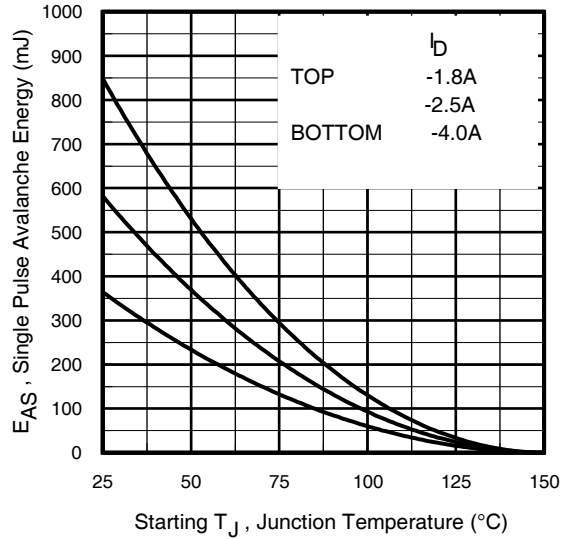

Fig 12c. Maximum Avalanche Energy Vs. Drain Current

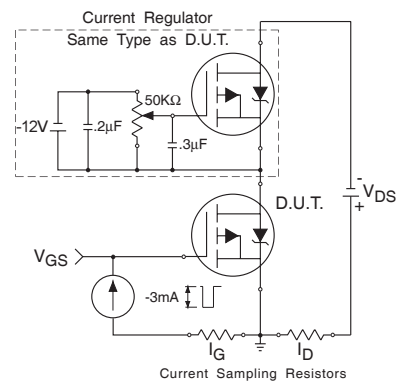

Fig 13b. Gate Charge Test Circuit

**Footnotes:**

- ① Repetitive Rating; Pulse width limited by maximum junction temperature.
- ②  $V_{DD} = -25V$ , starting  $T_J = 25^\circ C$ ,  
 Peak  $I_L = -4.0A$ ,  $L = 45.5mH$ ,  $V_{GS} = 10V$
- ③  $I_{SD} \leq -4.0A$ ,  $di/dt \leq -110A/\mu s$ ,  
 $V_{DD} \leq -100V$ ,  $T_J \leq 150^\circ C$   
 Suggested  $R_G = 7.5 \Omega$
- ④ Pulse width  $\leq 300 \mu s$ ; Duty Cycle  $\leq 2\%$

**Case Outline and Dimensions —TO-205AF (TO-39)**

