

Capacitor, Film, Metallized Polyester (Stacked), 0.1 uF, +/-5% Tol, -55/+105C, General Purpose, 63 VDC@85C, Lead Spacing=5 mm

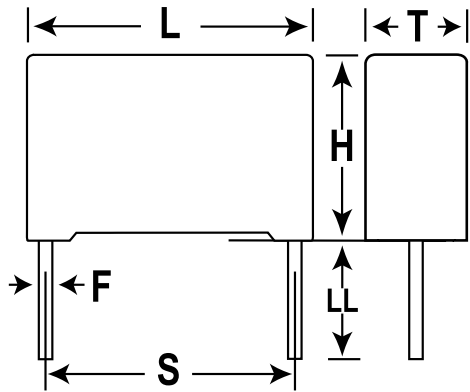

General Information	
Supplier:	KEMET
Dielectric:	Metallized Polyester (Stacked)
Application:	General Purpose
Sub Application:	AEC-Q200
Style:	Radial Box
Lead Form:	cut
Features:	Pulse
Approvals:	AEC-Q200
RoHS:	Yes

Dimensions (mm)		
Symbol	Dimension	Tolerance
L	7.2	+0.2
H	6.5	+0.1
T	2.5	+0.1
S	5	+/-0.4
LL	4	+1.5
F	0.5	+/-0.05

Specifications	
Capacitance:	0.1 uF
Voltage:	63 VDC
Tolerance:	+/-5%
Voltage AC:	40 VAC
Rated Temperature:	85C
Temperature Range:	-55/+105C
Dissipation Factor @ 1 kHz:	0.8%
Dissipation Factor @ 10 kHz:	1.2%
Dissipation Factor @ 100kHz:	2.5%
Insulation Resistance:	15 GOhm
Inductance:	7
Maximum dVdT:	160 v/us
Miscellaneous:	Above 85C DC And AC Voltage Derating Is 1.25%/C

Packaging Specifications	
Package Kind:	Bulk
Package Quantity:	3000