

Mechanical:

REV.	ECN NO.	DESCRIPTION	DATE	APPD
A	REL		07/08/2009	

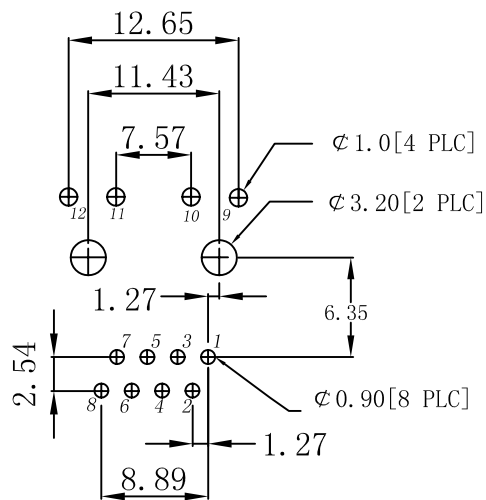

SUGGESTED PCB LAYOUT (TOP VIEW)

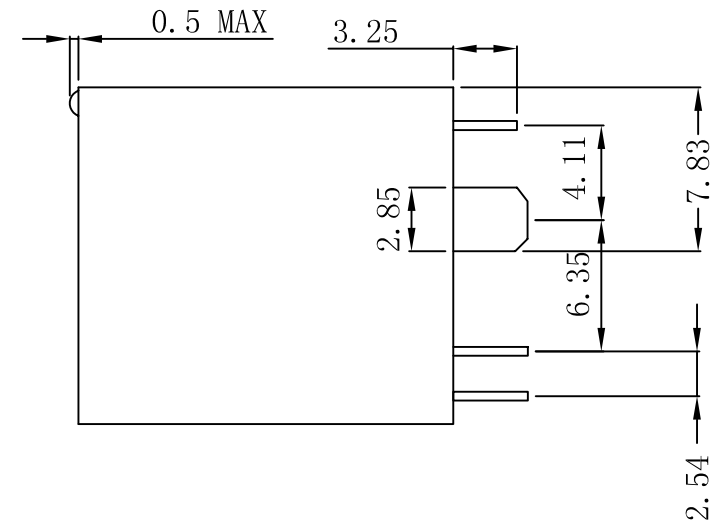
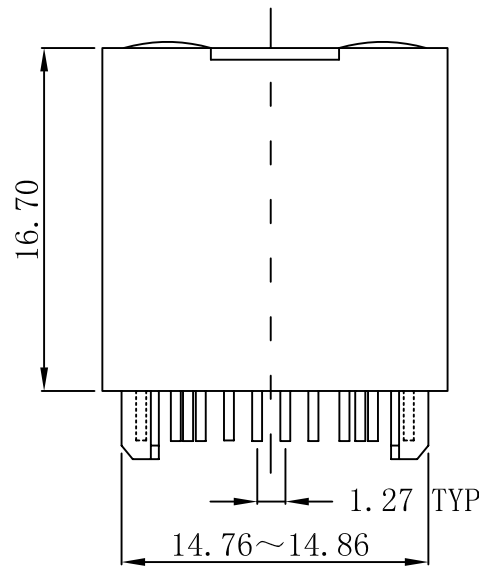
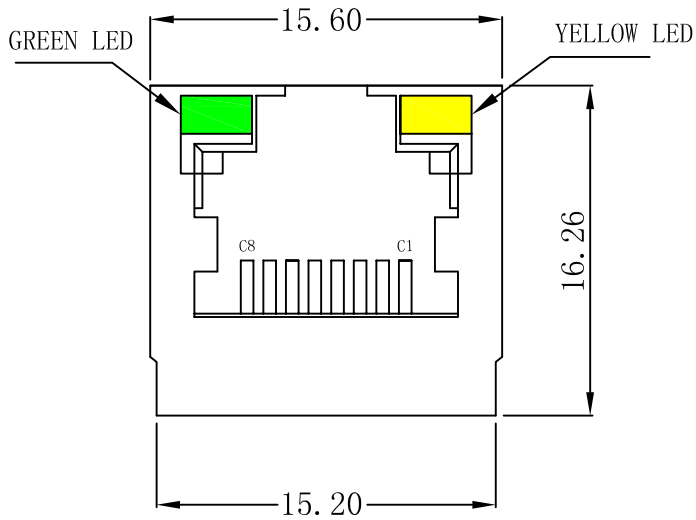

NOTES:

1. Designed to support application, such as SOHO (ADSL modems), LAN-on-Motherboard (LOM), hub and Switches.
2. Meets IEEE 802.3 specification
3. Connector Materials:
 Housing: Thermoplastic UL94V-0
 Contact/Shield: Copper alloy
 Shield plating: Nickel
 Contact plating: Gold 6 micro-inches min. In contact area.
4. Wave solder tip temperature: 265°C Max
 Wave solder tip temperature time: 5 Sec Max

X:X	±0.20	APPD:	LINK-PP INT'L TECHNOLOGY CO., LIMITED	
X:XX	±0.10	CHKD:		
X:XXX	±0.05	DR: TOM	Title: Vertical RJ45 Connector With 10/100 Magnetic	
ANGLES	±1°	UNIT: mm	PART NO.: LPJDO012NENL	
	SCALE: 2/1	SHEET: 1/2	REV: A	DWG NO.: LP09080701

Schematic:

REV.	ECN NO.	DESCRIPTION	DATE	APPD
A	REL		07/08/2009	

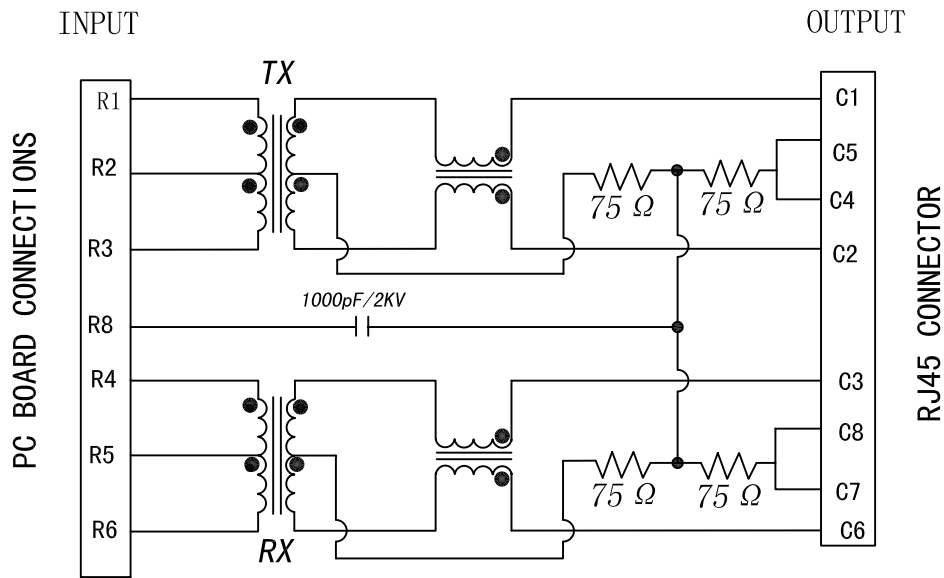

Electrical Specifications:

TEST NOTES (25±5°C)

- TR: (100KHZ, 0.1V);
TX=1:1 ±2% RX=1:1 ±2%
- LX: (100KHz, 100mV, 8mA, DC Bias)
PINS: (R1-R3), (R4-R6)=350uH MIN
- Transmitter filter & Receiver filter Type:
Balance low pass 100Ω impedance
- HIPOT:
Input (R1-R3) TO Output (C1-C2): 1500VAC 60sec
Input (R4-R6) TO Output (C3-C6): 1500VAC 60sec
- INSERTION LOSS:
-1.0dB MAX @ 1.0MHz TO 100MHz
- RETURN LOSS:
-18dB MIN @ 1.0MHz TO 30MHz
-16dB MIN @ 30MHz TO 60MHz
-12dB MIN @ 60MHz TO 80MHz
- CROSS TALK:
-30dB MIN @1.0MHz TO 100MHz
- COMMON MODE REJECTION:
-30dB MIN @1.0MHz TO 100MHz
- OPERATING TEMPERATURE: 0~70°C.

GREEN/LEFT LED

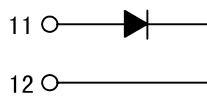

YELLOW/RIGHT LED

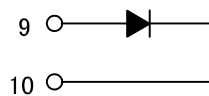

X:X	±0.20	APPD:	LINK-PP INT'L TECHNOLOGY CO., LIMITED
X:XX	±0.10	CHKD:	
X:XXX	±0.05	DR: TOM	Title: Vertical RJ45 Connector With 10/100 Magnetic
ANGLES	±1°	UNIT: mm	PART NO.: LPJDO012NENL
	SCALE: 2/1	SHEET: 2/2	REV: A DWG NO.: LP09080701