

FEATURES

- **Low Supply Current: 500 μ A**
- **0.2 μ A Supply Current in SHUTDOWN**
- **50 μ A Supply Current in RECEIVER ALIVE Mode**
- **ESD Protection Over ± 10 kV**
- **Operates from a Single 5V Supply**
- **Uses Small Capacitors: 0.1 μ F**
- **Operates to 120k Baud**
- **Three-State Outputs Are High Impedance When Off**
- **Output Overvoltage Does Not Force Current Back into Supplies**
- **RS232 I/O Lines Can Be Forced to ± 25 V Without Damage**
- **Flowthrough Architecture**

APPLICATIONS

- Battery-Powered Modems
- Battery-Powered DCE
- Notebook Computers
- Palmtop Computers

DESCRIPTION

The LTC1338 is a 5-driver/3-receiver RS232 transceiver with very low supply current. In the no load condition, the supply current is only 500 μ A. The charge pump only requires four 0.1 μ F capacitors.

In SHUTDOWN mode, the supply current is further reduced to 0.2 μ A. In RECEIVER ALIVE mode, all three receivers are kept alive and the supply current is 50 μ A. All RS232 outputs assume a high impedance state in SHUTDOWN and with the power off.

The LTC1338 is fully compliant with all data rate and overvoltage RS232 specifications. The transceiver can operate up to 120k baud with a 2500pF, 3k Ω load. Both driver outputs and receiver inputs can be forced to ± 25 V without damage, and can survive multiple ± 10 kV ESD strikes.

TYPICAL APPLICATION

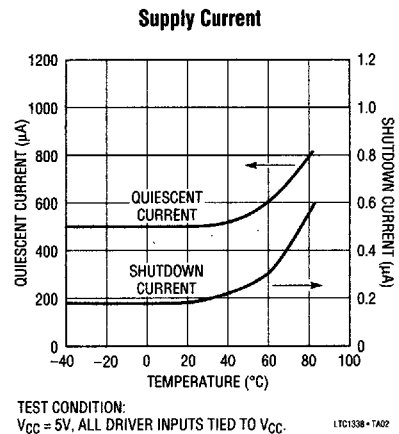
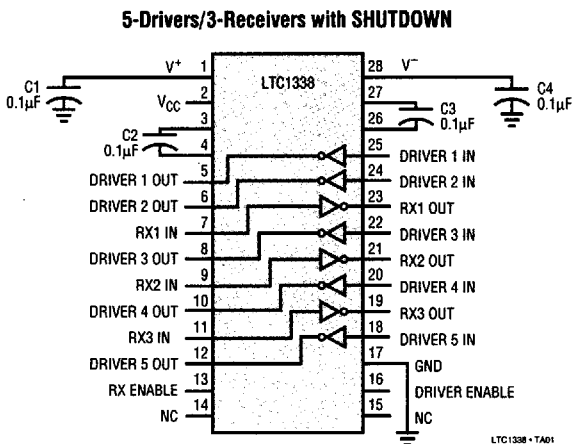

ABSOLUTE MAXIMUM RATINGS

(Note 1)

Supply Voltage (V_{CC})	6V
Input Voltage	
Driver	-0.3V to $V_{CC} + 0.3V$
Receiver	-25V to 25V
Driver/Receiver Enable Pin	-0.3V to $V_{CC} + 0.3V$
Output Voltage	
Driver	-25V to 25V
Receiver	-0.3V to $V_{CC} + 0.3V$
Short Circuit Duration	
V^+	30 sec
V^-	30 sec
Driver Output	Indefinite
Receiver Output	Indefinite
Operating Temperature Range	
Commercial (LTC1338C)	0°C to 70°C
Industrial (LTC1338I)	-40°C to 85°C
Storage Temperature Range	-65°C to 150°C
Lead Temperature (Soldering, 10 sec)	300°C

PACKAGE/ORDER INFORMATION

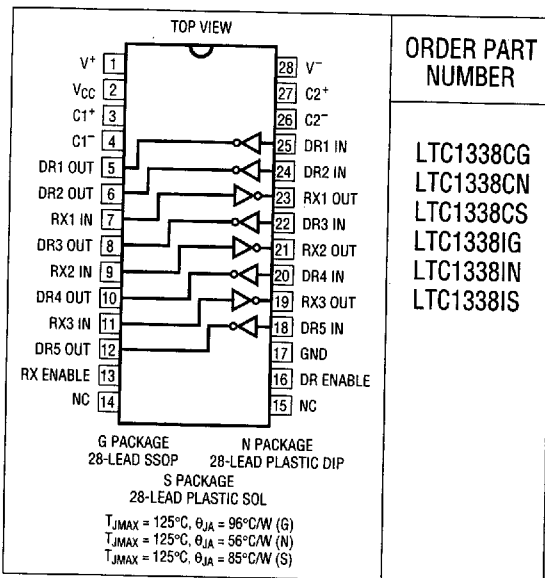

ORDER PART NUMBER

LTC1338CG
 LTC1338CN
 LTC1338CS
 LTC1338IG
 LTC1338IN
 LTC1338IS

Contact factory for Military grade parts.

DC ELECTRICAL CHARACTERISTICS

$V_{CC} = 5V, C1 = C2 = C3 = C4 = 0.1\mu F$, unless otherwise noted.

PARAMETER	CONDITIONS	MIN	TYP	MAX	UNITS	
Any Driver						
Output Voltage Swing	3k to GND				V	
		Positive	●	5.0	7.0	V
		Negative	●	-5.0	-6.5	V
Logic Input Voltage Level	Input Low Level ($V_{OUT} = \text{High}$)	●		1.4	0.8	V
	Input High Level ($V_{OUT} = \text{Low}$)	●		2.0	1.4	V
Logic Input Current	$0 \leq V_{IN} \leq V_{CC}$	●			±5	μA
Output Short-Circuit Current	$V_{OUT} = 0V$				±12	mA
Output Leakage Current	SHUTDOWN, $V_{OUT} = \pm 20V$ (Note 3)	●		±10	±500	μA
Any Receiver						
Input Voltage Thresholds	Input Low Threshold	●	0.8	1.3	V	
	Input High Threshold	●		1.7	2.4	V
Hysteresis		●	0.1	0.4	1	V
Input Resistance	$-10V \leq V_{IN} \leq 10V$		3	5	7	kΩ
Output Voltage	Output Low, $I_{OUT} = -1.6mA$ ($V_{CC} = 5V$)	●		0.2	0.4	V
	Output High, $I_{OUT} = 160\mu A$ ($V_{CC} = 5V$)	●		3.5	4.8	V
Output Short-Circuit Current	Sinking Current, $V_{OUT} = V_{CC}$			-15	-40	mA
Output Leakage Current	SHUTDOWN, $0 \leq V_{OUT} \leq V_{CC}$ (Note 3)	●		1	10	μA
Power Supply Generator						
V^+ Output Voltage	$I_{OUT} = 0mA$			8.0	V	
	$I_{OUT} = 12mA$			7.5	V	
V^- Output Voltage	$I_{OUT} = 0mA$			-8.0	V	
	$I_{OUT} = -12mA$			-7.0	V	
Supply Rise Time	SHUTDOWN to Turn-On			0.2	ms	

DC ELECTRICAL CHARACTERISTICS $V_{CC} = 5V, C1 = C2 = C3 = C4 = 0.1\mu F$, unless otherwise noted.

PARAMETER	CONDITIONS	MIN	TYP	MAX	UNITS
Power Supply					
V_{CC} Supply Current	No Load (All Driver $V_{IN} = V_{CC}$)(Note 2) $0^{\circ}C \leq T_A \leq 70^{\circ}C$		0.5	1.0	mA
	No Load (All Driver $V_{IN} = 0V$)(Note 2) $0^{\circ}C \leq T_A \leq 70^{\circ}C$		1.0	1.5	mA
	No Load (All Driver $V_{IN} = V_{CC}$)(Note 2) $-40^{\circ}C \leq T_A \leq 85^{\circ}C$		0.5	1.5	mA
	No Load (All Driver $V_{IN} = 0V$)(Note 2) $-40^{\circ}C \leq T_A \leq 85^{\circ}C$		1.0	2.0	mA
	RECEIVER ALIVE Mode (Note 4)	●	50	80	μA
Supply Leakage Current (V_{CC})	SHUTDOWN (Note 3)	●	0.2	10	μA
Driver/Receiver Enable Threshold Low		●	1.4	0.8	V
Driver/Receiver Enable Threshold High		●	2.0	1.4	V

AC CHARACTERISTICS $V_{CC} = 5V, C1 = C2 = C3 = C4 = 0.1\mu F$, unless otherwise noted.

PARAMETER	CONDITIONS	MIN	TYP	MAX	UNITS
Slew Rate	$R_L = 3k, C_L = 51pF$		8	30	V/ μs
	$R_L = 3k, C_L = 2500pF$	3	5		V/ μs
Driver Propagation Delay (TTL to RS232)	t_{HLD} (Figure 1)	●	2	3.5	μs
	t_{LHD} (Figure 1)	●	2	3.5	μs
Receiver Propagation Delay (RS232 to TTL)	t_{HLR} (Figure 2)	●	0.3	0.8	μs
	t_{LHR} (Figure 2)	●	0.2	0.8	μs

The ● denotes specifications which apply over the operating temperature range of $0^{\circ}C$ to $70^{\circ}C$ or $-40^{\circ}C$ to $85^{\circ}C$.

Note 1: Absolute maximum ratings are those values beyond which the life of the device may be impaired.

Note 2: Supply current is measured with driver and receiver outputs unloaded. The $V_{DRIVER ENABLE}$ and $V_{RECEIVER ENABLE} = V_{CC}$.

Note 3: Supply current and leakage current measurements in SHUTDOWN are performed with $V_{DRIVER ENABLE}$ and $V_{RECEIVER ENABLE} = 0V$.

Note 4: Supply current measurement in RECEIVER ALIVE mode is performed with $V_{DRIVER ENABLE} = 0V$ and $V_{RECEIVER ENABLE} = V_{CC}$.

TYPICAL PERFORMANCE CHARACTERISTICS

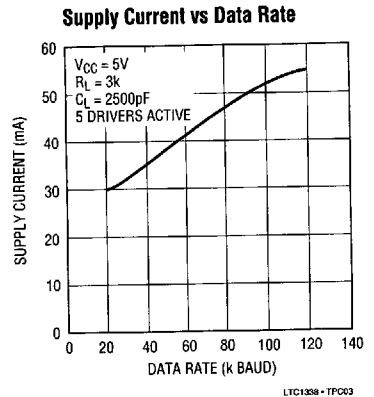
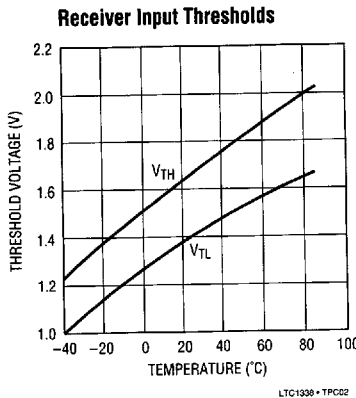
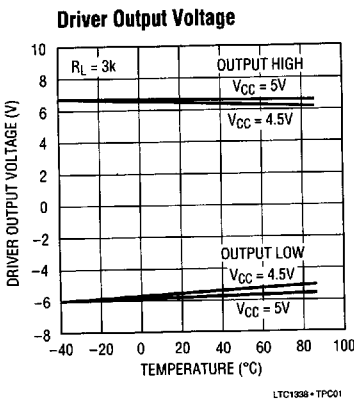

TYPICAL PERFORMANCE CHARACTERISTICS

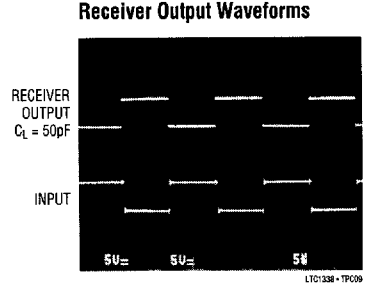
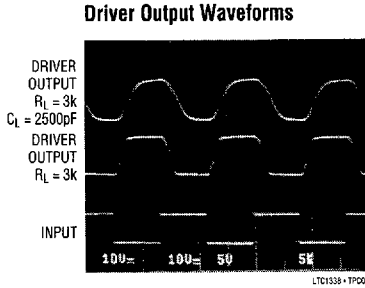
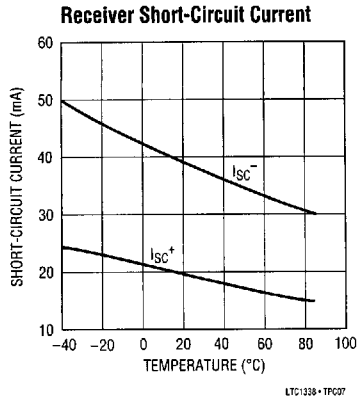
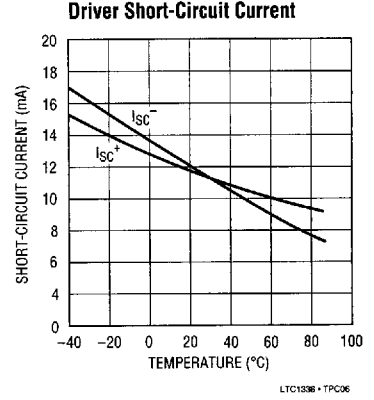
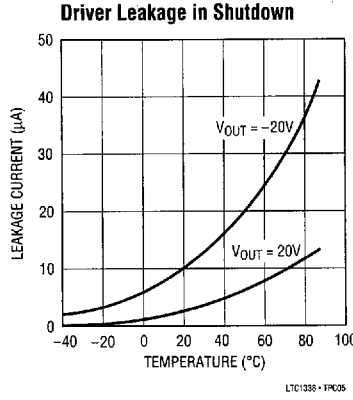
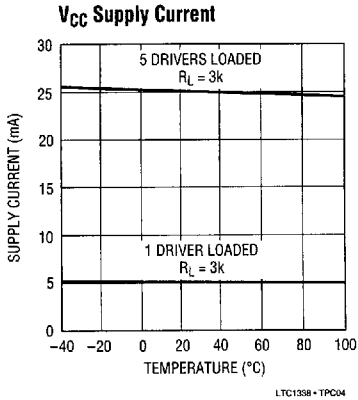

PIN FUNCTIONS

V_{CC}: 5V Input Supply Pin. Supply current less than 0.2µA in the SHUTDOWN mode. This pin should be decoupled with a 0.1µF ceramic capacitor.

GND: Ground Pin.

RECEIVER ENABLE: TTL/CMOS Compatible Enable Pin. Refer to Table 1 for its functional description. This pin can not float.

DRIVER ENABLE: TTL/CMOS Compatible Enable Pin. Refer to Table 1 for its functional description. This pin can not float.

V⁺: Positive Supply Output (RS232 Drivers). V⁺ ≅ 2V_{CC} - 1V. This pin requires an external capacitor C = 0.1µF for

charge storage. The capacitor may be tied to ground or 5V. With multiple devices, the V⁺ and V⁻ pins may be paralleled into common capacitors. For large numbers of devices, increasing the size of the shared common storage capacitors is recommended to reduce ripple.

V⁻: Negative Supply Output (RS232 Drivers). V⁻ ≅ 2V_{CC} - 1.5V. This pin requires an external capacitor C = 0.1µF for charge storage.

C1⁺, C1⁻, C2⁺, C2⁻: Commutating Capacitor Inputs. These pins require two external capacitors C = 0.1µF: one from C1⁺ to C1⁻, and another from C2⁺ to C2⁻. To maintain charge pump efficiency, the capacitor's effective series resistance should be less than 20Ω.

PIN FUNCTIONS

DRIVER IN: RS232 Driver Input Pins. Inputs are TTL/CMOS compatible. Inputs should not be allowed to float. Tie unused inputs to V_{CC} .

DRIVER OUT: Driver Outputs at RS232 Voltage Levels. Outputs are in a high impedance state when in SHUTDOWN, RECEIVER ALIVE mode or $V_{CC} = 0V$. The driver outputs are protected against ESD to $\pm 10kV$ for human body model discharges.

RX IN: Receiver Inputs. These pins can be forced to $\pm 25V$ without damage. The receiver inputs are protected against ESD to $\pm 10kV$ for human body model discharges. Each receiver provides 0.4V of hysteresis for noise immunity.

RX OUT: Receiver Outputs with TTL/CMOS Voltage Levels. Outputs are in a high impedance state when in SHUTDOWN or RECEIVER DISABLE mode to allow data line sharing.

Table 1. Functional Description

MODE	RX ENABLE	DR ENABLE	DRIVERS	RECEIVERS	I_{CC} (μA)(TYP)
SHUTDOWN	0	0	All driver outputs are high impedance.	All receiver outputs are high impedance.	0.2
Receiver Disable	0	1	All drivers alive.	All receiver outputs are high impedance.	500
RECEIVER ALIVE	1	0	All driver outputs are high impedance.	All receivers alive.	50
Normal	1	1	All drivers alive.	All receivers alive.	500

SWITCHING TIME WAVEFORMS

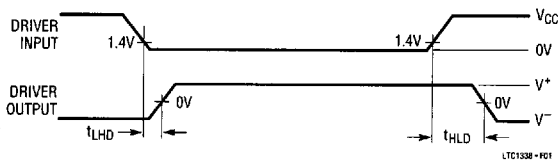

Figure 1. Driver Propagation Delay Timing

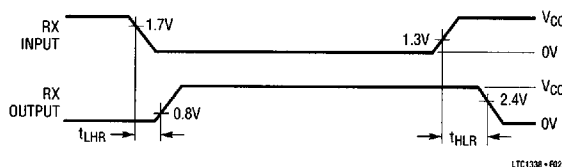
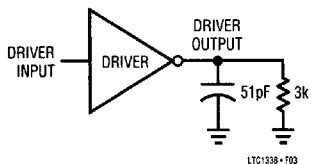

Figure 2. Receiver Propagation Delay Timing

TEST CIRCUITS

Driver Timing Test Load



Receiver Timing Test Load

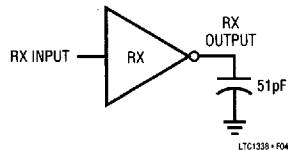

ESD Test Circuit

