

MORNSUN®

UFA_MP-6W & UFB_MP-6W Series 6W, WIDE INPUT, ISOLATED & REGULATED DUAL & SINGLE OUTPUT DC-DC CONVERTER



Patent Protection RoHS

PART NUMBER SYSTEM

UFA2405MP-6W

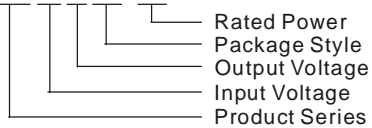

FEATURES

- DIP package
- Efficiency up to 85%
- 4:1 wide input voltage range
- 1.5KVDC input/output isolation
- Continuous short circuit protection
- Operating temperature range: -40°C ~ +85°C
- Metal shielding package
- Good high temperature properties, can meet the industrial products technical requirements

APPLICATIONS

The UFA_MP-6W & UFB_MP-6W Series are specially designed for applications where a wide range input voltage power supplies are unregulated from the input power supply in a distributed power supply system on a circuit board.

These products apply to where:

- 1) Input voltage range $\leq 4:1$;
- 2) 1.5KVDC input and output isolation;
- 3) Output regulated and low ripple noise is required.

SELECTION GUIDE

Model Number	Input Voltage(VDC)		Output Voltage (VDC)	Output Current (mA)		Input Current (mA)(typ.)		Reflected Ripple Current (mA,typ.)	Max. Capacitive Load# (μF)	Efficiency (% , typ.) @Max. Load
	Nominal (Range)	Max.		Max.	Min.	@Max. Load	@No Load			
UFA2405MP-6W	24 (9-36)	40	±5	±600	±60	300	15	260	470	80
UFA 2412MP-6W			±12	±250	±25				220	80
UFA 2415MP-6W			±15	±200	±20				68	82
UFA 2424MP-6W			±24	±125	±13				68	83
UFB2403MP-6W			3.3	1500	150				2000	78
UFB2405MP-6W			5	1200	120				1500	80
UFB2412MP-6W			12	500	50				350	82
UFB2415MP-6W			15	400	40				200	82
UFB2424MP-6W			24	250	25				100	83
UFA4805MP-6W			48 (18-75)	80	±5				±600	±60
UFA4812MP-6W	±12	±250			±25	220	82			
UFA4815MP-6W	±15	±200			±20	68	84			
UFA4824MP-6W	±24	±125			±13	68	85			
UFB4803MP-6W	3.3	1500			150	2000	76			
UFB4805MP-6W	5	1200			120	1500	80			
UFB4812MP-6W	12	500			50	500	84			
UFB4815MP-6W	15	400			40	350	85			
UFB4824MP-6W	24	250			25	100	86			

Note: 1. Models listed with strike-through text have been officially discontinued.
2.* Input voltage can't exceed this value, or will cause the permanent damage.
3. # For each output.

INPUT SPECIFICATIONS

Item	Test Conditions	Min.	Typ.	Max.	Unit
Input Surge Voltage (1sec.max.)	24VDC Input Models	-0.7	--	50	VDC
	48VDC Input Models	-0.7	--	100	
Start Voltage	24VDC Input Models	--	--	9	
	48VDC Input Models	--	--	18	
Under Voltage Shutdown	24VDC Input Models	--	--	9	
	48VDC Input Models	--	--	18	

Short Circuit Input Power		--	--	3	W
Input Filter		π Filter			

OUTPUT SPECIFICATIONS

Item	Test Conditions	Min.	Typ.	Max.	Unit
Output Power		0.6	--	6	W
Positive Voltage Accuracy	Refer to recommended circuit	--	±1	±3	%
Negative Voltage Accuracy		--	±3	±5	
Output Voltage Balance	Dual output, balanced loads	--	±1	±1.5	
Line Regulation	Full load, Input voltage from low to high	--	±0.2	±0.5	
Load Regulation	From 10% to 100% load	--	±0.5	±2	
Cross Regulation	Dual output	--	--	±5	
Transient Recovery Time	25% load step change	--	200	500	μs
Transient Response Deviation		--	±3	±5	%
Temperature Drift	100% full load	--	--	±0.03	%/°C
Ripple *	20MHz Bandwidth	--	30	40	mVp-p
Noise*		--	100	150	
Over Current Protection	Full input voltage	110	--	--	%
Short Circuit Protection		Continuous, automatic recovery			

Note: 1. Dual output models unbalanced load: ±5%.
2. *Test ripple and noise by "parallel cable" method. See detailed operation instructions at Testing of Power Converter section, application notes.

COMMON SPECIFICATIONS

Item	Test Conditions	Min.	Typ.	Max.	Unit
Isolation Voltage	Tested for 1 minute and 1mA max	1500	--	--	VDC
Isolation Resistance	Test at 500VDC	1000	--	--	MΩ
Isolation Capacitance	Input/Output, 100KHz/1V	--	100	--	pF
Switching Frequency	100% load, input voltage range	--	300	--	KHz
MTBF	MIL-HDBK-217F @25°C	1000	--	--	K hours
Case Material		Copper, nickel plated			
Weight		--	17	--	g

ENVIRONMENTAL SPECIFICATIONS

Item	Test Conditions	Min.	Typ.	Max.	Unit
Storage Humidity	Non condensing	--	--	95	%
Operating Temperature	Power derating (above 85°C)	-40	--	85	°C
Storage Temperature		-55	--	125	
Maximum Case temp.	On working temperature	--	75	--	
Lead Temperature	1.5mm from case for 10 seconds	--	--	300	
Cooling		Free air convection			

EMC SPECIFICATIONS

EMI	CE	CISPR22/EN55022 CLASS A (External Circuit Refer to Figure1、 2)			
EMS	ESD	IEC/EN61000-4-2 Contact ±4KV perf. Criteria B			
	EFT	IEC/EN61000-4-4 ±2KV perf. Criteria B (External Circuit Refer to Figure 1、 2)			
	Surge	IEC/EN61000-4-5 ±2KV perf. Criteria B (External Circuit Refer to Figure 1、 2)			

EMC RECOMMENDED CIRCUIT

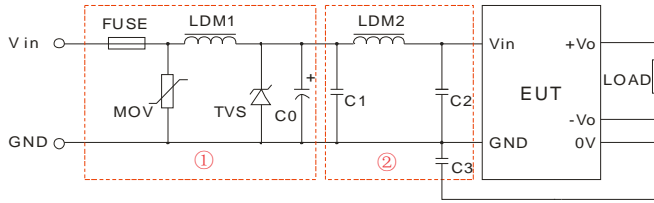

(Figure 1) UFA_MP-6W

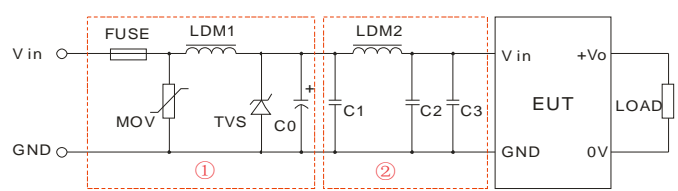

(Figure 2) UFB_MP-6W

Recommended external circuit parameters	Vin: 24V (Figure 1)	Vin: 24V (Figure 2)	Vin: 48V (Figure 1)	Vin: 48V (Figure 2)
FUSE	Choose according to practical input current			
MOV	10D560K		10D101K	
LDM1	82μH		56μH	
TVS	SMCJ48A		SMCJ90A	
C0	120μF/50V		120μF/100V	
C1	4.7μF/50V	2.2μF/50V	4.7μF/100V	2.2μF/100V
C2	--			
C3	1000pF/2KV		--	
LDM2	4.7μH	10μH	4.7μH	10μH

Note: 1. In Figure 1、2, part ① is EMS Recommended external circuit, part ② is EMI recommended external circuit. Choose according to requirements.
2. If there is no recommended parameters, the model no require the external component.

EMC RECOMMENDED CIRCUIT PCB LAYOUT

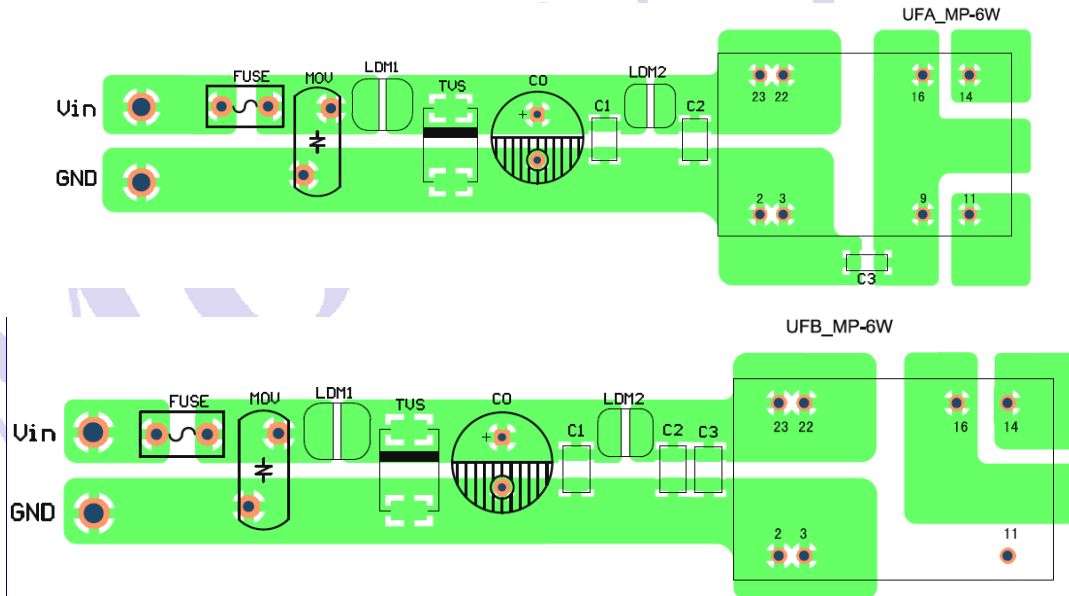

(Figure 3)

PRODUCT TYPICAL CURVE

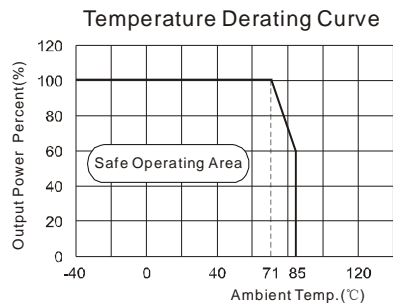

**Efficiency VS Input Voltage curve
(Full Load)**

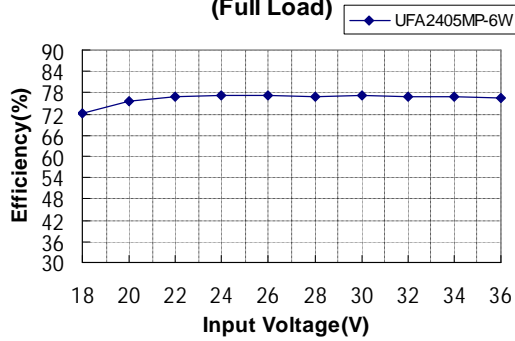

**Efficiency VS Input Voltage curve
(Full Load)**

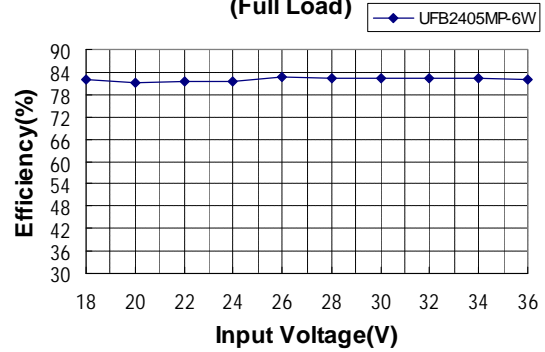

**Efficiency VS Output Load curve
(Vin=Vin-nominal)**

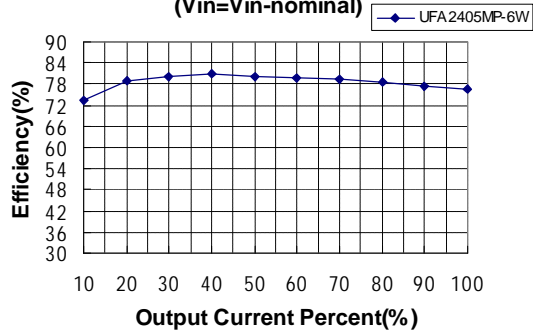

**Efficiency VS Output Load curve
(Vin=Vin-nominal)**

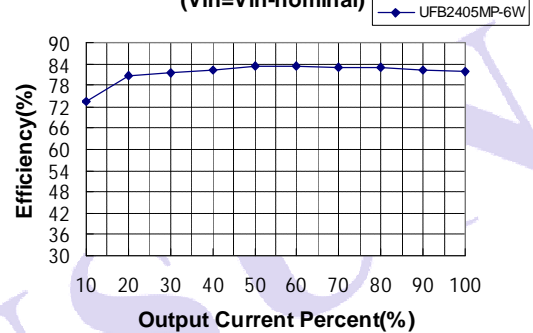

OUTLINE DIMENSIONS, RECOMMENDED FOOTPRINT & PACKAGING

MECHANICAL DIMENSIONS

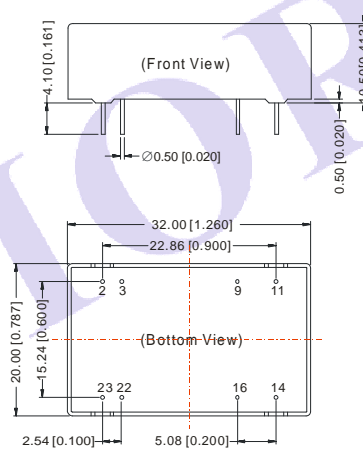

FOOTPRINT DETAILS		
Pin	Single	Dual
2,3	GND	GND
9	No Pin	0V
11	NC	-Vo
14	+Vo	+Vo
16	0V	0V
22,23	Vin	Vin

NC: No connection

Note:
Unit: mm[inch]
Pin diameter tolerances: $\pm 0.10\text{mm} [\pm 0.004\text{inch}]$
General tolerances: $\pm 0.25\text{mm} [\pm 0.010\text{inch}]$

RECOMMENDED FOOTPRINT

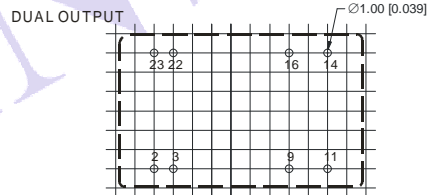

SINGLE OUTPUT

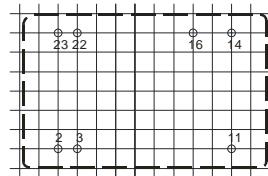

Note: grid 2.54*2.54mm.

TUBE OUTLINE DIMENSIONS

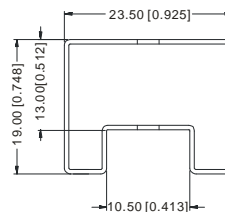

Note:
Unit : mm[inch]
General tolerances: $\pm 0.50\text{mm} [\pm 0.020\text{inch}]$
L=530mm[20.866inch] Tube Quantity: 15pcs
L=220mm[8.661inch] Tube Quantity: 6pcs
Short tube inner package dimensions: L*W*H= 255*170*80mm
Short tube outer package dimensions(with six inner package boxes):
L*W*H= 375*280*270mm
Long tube inner package dimensions: L*W*H= 580*200*100mm
Long tube outer package dimensions(with two inner package boxes):
L*W*H= 600*215*220mm
Long tube outer package dimensions(with three inner package boxes):
L*W*H= 600*215*325mm

TEST CONFIGURATIONS

Input Reflected-Ripple Current Test Setup

Input reflected-ripple current is measured with a inductor L_{in} and C_{in} to simulate source impedance.

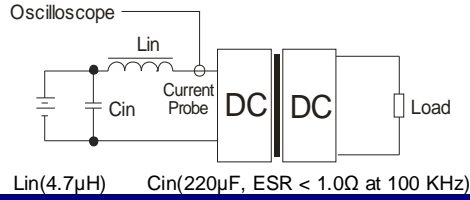

DESIGN & APPLY CONSIDERATIONS

1) Requirement on output load

To ensure this module can operate efficiently and reliably, During operation, the minimum output load **could not be less than 10% of the full load**. If the actual output power is very small, please connect a resistor with proper resistance at the output end in parallel to increase the load, or use our company's products with a lower rated output power.

2) Overload Protection

Under normal operating conditions, the output circuit of these products has no protection against overload. The simplest method is add a circuit breaker to the circuit.

3) Recommended Circuit

All the UFA_MP-6W & UFB_MP-6W series have been tested according to the following recommended testing circuit before leaving factory. This series should be tested under load. Never be tested under no load (see Figure 4).

If you want to further decrease the output ripple, you can increase capacitance properly or choose capacitors with low ESR. However, the capacitance should not be too high (Table 1).

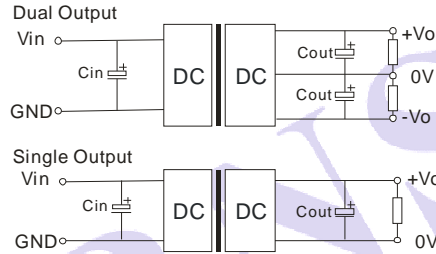

(Figure 4)

EXTERNAL CAPACITOR TABLE (TABLE 1)

Output Voltage		Capacitance $C_{out}^{\#}(\mu F)$	$C_{in}(\mu F)$
Single	3.3V, 5V	220	100
	12V, 15V	100	
	24V	47	
Dual	$\pm 5V$	100	
	$\pm 12V, \pm 15V$	47	
	$\pm 24V$	22	

Note: # For each output.

4) No parallel connection or plug and play

Note:

- The load shouldn't be less than 10%, otherwise ripple will increase dramatically. Operation under minimum load will not damage the converter; However, they may not meet all specification listed.
- All specifications measured at $T_a=25^{\circ}C$, humidity<75%, nominal input voltage and rated output load unless otherwise specified.
- In this datasheet, all the test methods of indications are based on corporate standards.
- Only typical models listed, other models may be different, please contact our technical person for more details.
- Our company offer custom products.
- Specifications subject to change without notice.

MORNSUN Science & Technology Co.,Ltd.

Address: No. 5, Kehui St. 1, Kehui development center, Science Ave., Guangzhou Science City, Luogang district, Guangzhou, P.R.China.

Tel: 86-20-28203030

Fax: 86-20-38601272

[Http://www.mornsun-power.com](http://www.mornsun-power.com)