



## WRA\_D-10W & WRB\_D-10W Series 10W, 2:1 WIDE INPUT ISOLATED & REGULATED DUAL/SINGLE OUTPUT DC-DC CONVERTER

Patent Protection RoHS

### FEATURES

- 2:1 wide input voltage range
- DIP package
- Efficiency up to 85%
- 1.5KVDC input/output Isolation
- Short circuit protection (automatic recovery)
- Operating temperature: -40°C to +85°C
- Metal shielding package
- No heat sink required
- Industry standard pinout
- MTBF>1,000,000 hours
- RoHS Compliance

### APPLICATIONS

The WRA\_D-10W & WRB\_D-10W series are specially designed for applications where a wide range input voltage power supplies are isolated from the input power supply in a distributed power supply system on a circuit board.

These products apply to:

- 1) Where the voltage of the input power supply is wide range (voltage ranges $\leq$ 2:1);
- 2) Where isolation is necessary between input and output(Isolation Voltage  $\leq$  1500VDC);
- 3) Where the regulation of the output voltage and the output ripple noise are demanded.

### MODEL SELECTION

WRA0515D-10W

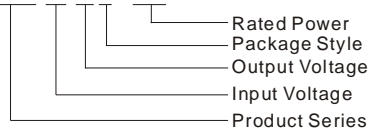

### PRODUCT PROGRAM

Part Number	Input			Output			Efficiency (% Typ.)
	Voltage (VDC)			Voltage (VDC)	Current (mA)		
	Nominal	Range	Max.*		Max.	Min.	
WRA0505D-10W	5	4.5-9	11	±5	±1000	±100	76
WRA0512D-10W				±12	±416	±42	80
WRA0515D-10W				±15	±333	±33	82
WRB0505D-10W				5	2000	200	76
WRB0512D-10W				12	833	83	80
WRB0515D-10W				15	666	66	82
WRA1205D-10W				12	9-18	20	±5
WRA1212D-10W	±12	±416	±42				82
WRA1215D-10W	±15	±333	±33				84
WRB1203D-10W	3.3	2500	250				72
WRB1205D-10W	5	2000	200				79
WRB1212D-10W	12	833	83				82
WRB1215D-10W	15	666	66				84
WRB1224D-10W	24	416	42	82			
WRA2405D-10W	24	18-36	40	±5	±1000	±100	81
WRA2412D-10W				±12	±416	±42	84
WRA2415D-10W				±15	±333	±33	83
WRA2424D-10W				±24	±208	±21	84
WRB2403D-10W				3.3	2500	250	74
WRB2405D-10W				5	2000	200	80
WRB2412D-10W				12	833	83	84
WRB2415D-10W	15	666	66	85			
WRB2424D-10W	24	417	42	85			
WRB2448D-10W	48	208	21	84			
WRA4805D-10W	48	36-72	80	±5	±1000	±100	80
WRA4812D-10W				±12	±416	±42	84
WRA4815D-10W				±15	±333	±33	85
WRB4803D-10W				3.3	2500	250	75
WRB4805D-10W				5	2000	200	80
WRB4812D-10W				12	833	83	83
WRB4815D-10W				15	666	66	85
WRB4824D-10W	24	417	42	84			

\*Input voltage can't exceed this value, or will cause the permanent damage. O: PWM mode, others PFM mode.

### MORNSUN Science & Technology Co., Ltd.

Address: No. 5, Kehui St. 1, Kehui development center, Science Ave., Guangzhou Science City, Luogang district, Guangzhou, P.R.China.

Tel: 86-20-28203030

Fax: 86-20-38601272

[Http://www.mornsun-power.com](http://www.mornsun-power.com)

## COMMON SPECIFICATIONS

Item	Test conditions	Min.	Typ.	Max.	Units
Storage Humidity				95	%
Operating Temperature		-40		85	°C
Storage Temperature		-55		125	
Temp. Rise at Full Load			40		
Lead Temperature	1.5mm from case for 10 seconds			300	
No-load power consumption			500		mW
Cooling	Free Air Convection				
Short Circuit Protection	Continuous, automatic recovery				
Case Material	Aluminum				
MTBF		1000			K hours
Weight			23.5		g

## ISOLATION SPECIFICATIONS

Item	Test conditions	Min.	Typ.	Max.	Units
Isolation voltage	Tested for 1 minute and 1 mA max	1500			VDC
Isolation resistance	Test at 500VDC	1000			MΩ
Isolation capacitance	Input/Output, 100KHz/1V		1000		pF

## OUTPUT SPECIFICATIONS

Item	Test Conditions	Min.	Typ.	Max.	Units
Output power	Refer to products program	1		10	W
Positive voltage accuracy	Refer to recommended circuit		±1	±3	%
Negative voltage accuracy	Refer to recommended circuit		±3	±5	
Load regulation	From 10% to 100% load		±0.5	±1*	
Line regulation(at full load)	Input voltage from low to high		±0.2	±0.5	mVp-p
Temperature drift (Vout)	Refer to recommended circuit			±0.03	
Ripple**	20MHz Bandwidth		20	50	
Noise**	20MHz Bandwidth		85	150	KHz
Switching frequency	100% load, Input voltage range		300		

\*Dual output models unbalanced load: ±5%.

\*\*Test ripple and noise by "parallel cable" method. See detailed operation instructions at Testing of Power Converter section, application notes.

## APPLICATION NOTE

### 1) Requirement on Output Load

In order to ensure the product operate efficiently and reliably, in addition to a max load (namely full load), a minimum load is specified for this kind of DC/DC converter. Make sure the specified range of input voltage is not exceeded, the minimum output load no less than 10% load. If the actual load is less than the specified minimum load, the output ripple may increase sharply while its efficiency and reliability will reduce greatly. If the actual output power is very small, please add an appropriate resistor as extra loading, or contact our company for other lower output power products.

### 2) Recommended Circuit

All the WRA\_D-10W & WRB\_D-10W Series have been tested according to the following recommended testing circuit before leaving factory. This series should be tested under load. Never be tested under no load (see Figure 1).

If you want to further decrease the input/output ripple, you can increase capacitance properly or choose capacitors with low ESR. However, the capacitance of the output filter capacitor must be proper. If the capacitance is too big, a startup problem might arise. For every channel of output, provided the safe and reliable operation is ensured, the greatest capacitance of its filter capacitor sees (Table 1). General:

Cin: 5V&12V 100μF  
24V&48V 10μF-47μF

Cout: 10μF/100mA

### 3) Input Current

When it is used in unregulated power supply, be sure that the fluctuating range of the power supply and the rippled voltage do not exceed the module standard. Input current of power supply should afford the startup current of this kind of DC/DC module (See figure 2), General:

$$I_p \leq 1.4 \cdot I_{in-max}$$

### 4) No parallel connection or plug and play

## TYPICAL CHARECTERISTICS

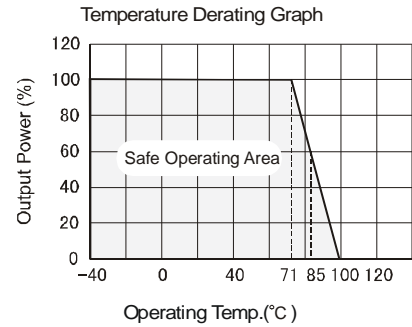

## RECOMMENDED CIRCUIT

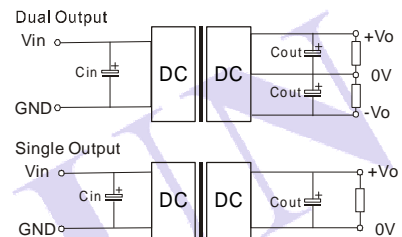

(Figure 1)

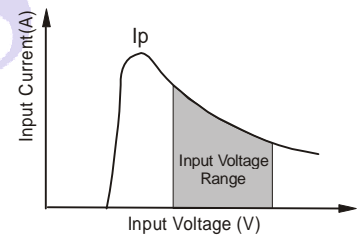

(Figure 2)

Output External Capacitor Table (Table 1)

Single Vout (VDC)	Cout (uF)	Dual Vout (VDC)	Cout (uF)
3.3	2200	±5	680
5	1000	±12	330
12	470	±15	220
15	330	±24	100
24	220	-	-
48	100	-	-

## OUTLINE DIMENSIONS & FOOTPRINT DETAILS

### MECHANICAL DIMENSIONS

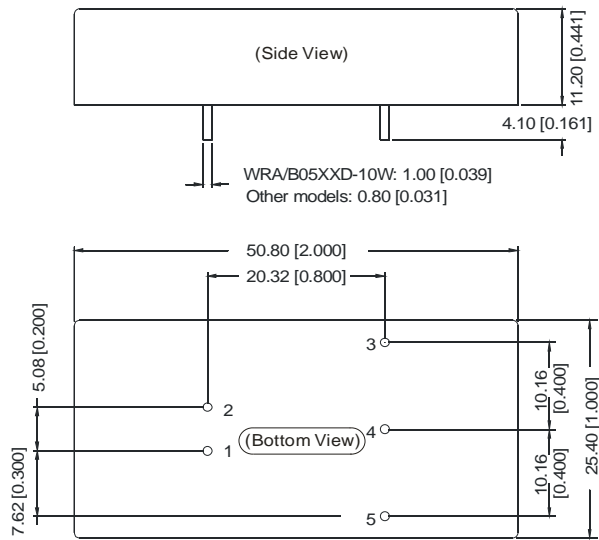

Note:  
Unit:mm[inch]  
Pin diameter tolerances:±0.10mm[±0.004inch]  
General tolerances:±0.25mm[±0.010inch]

#### FOOTPRINT DETAILS

Pin	Single	Dual
1	GND	GND
2	Vin	Vin
3	+Vo	+Vo
4	No Pin	0V
5	0V	-Vo

### RECOMMENDED FOOTPRINT(TOP VIEW)

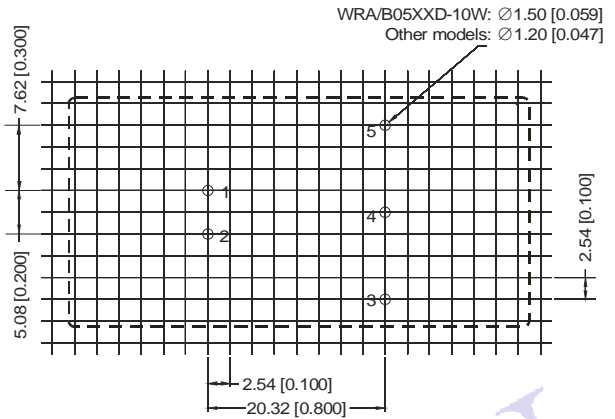

### TUBE OUTLINE DIMENSIONS

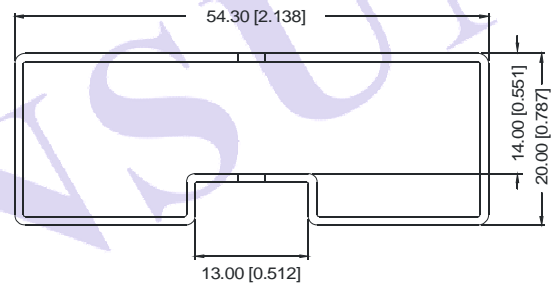

Note:  
Unit :mm[inch]  
General tolerances: ±0.50mm[±0.020inch]  
L=230mm[9.055inch] Tube Quantity: 7pcs

#### Note:

1. The load shouldn't be less than 10%, otherwise ripple will increase dramatically.
2. Operation under 10% load will not damage the converter; However, they may not meet all specification listed.
3. All specifications measured at Ta=25°C, humidity<75%, nominal input voltage and rated output load unless otherwise specified.
4. In this datasheet, all the test methods of indications are based on corporate standards.
5. Only typical models listed, other models may be different, please contact our technical person for more details.