

**NOTES**

1. 材質  
MATERIAL  
ハウジング : ガラス入りLCP、黒色、UL94V-0  
HOUSING : GLASS FILLED LIQUID CRYSTAL POLYMER, BLACK, UL94V-0  
ターミナル : 銅合金  
TERMINAL : COPPER ALLOY  
シールド : ステンレス鋼  
SHIELD : STAINLESS STEEL  
ネイル : 銅合金  
NAIL : COPPER ALLOY  
吸着テープ : 耐熱樹脂  
VACUUM TAPE : HEAT RESISTING RESIN

2. めっき仕様  
PLATING  
ターミナル  
TERMINAL  
接点部 : 金めっき  
CONTACT AREA : GOLD  
半田付け部 : 錫めっき  
SOLDER TAIL AREA : TIN  
下地めっき : ニッケルめっき  
UNDER-PLATING : NICKEL
3. テールとネイルの平坦度 : 0.1MAX  
COPLANARITY : 0.1 MAXIMUM

ネイル  
NAIL  
ニッケル下地めっき  
TIN OVER NICKEL PLATING

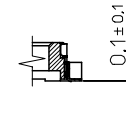
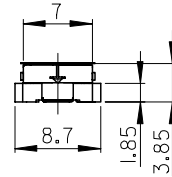
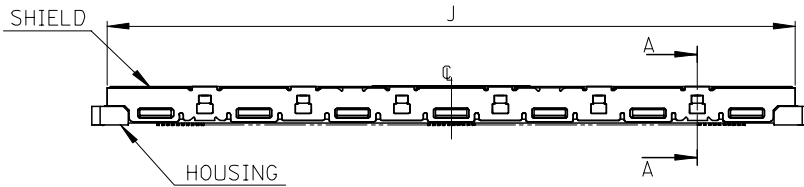
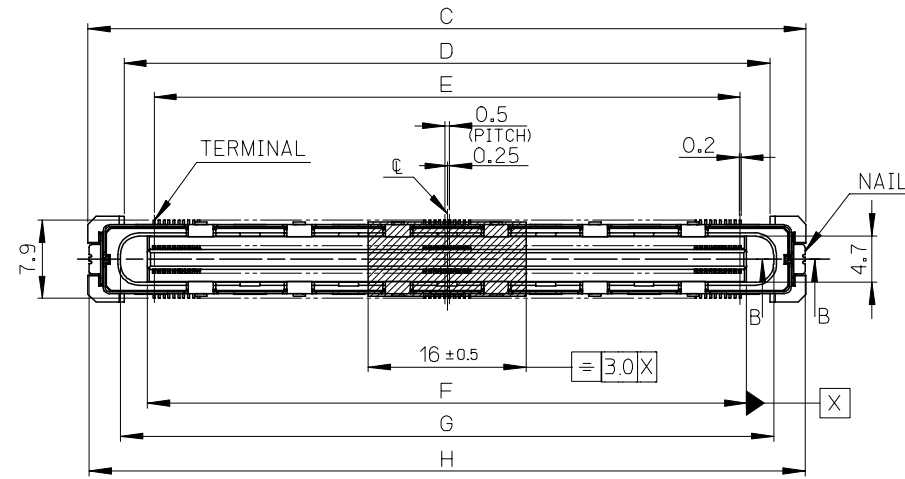

**SECTION B-B**

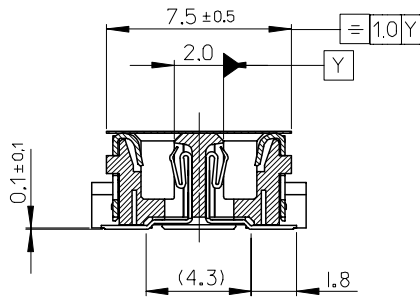

**SECTION A-A**  
5-1

501497-24**	501497-20** 501497-16**
シールドコンタクト形状 SHIELD CONTACT SHAPE	

52.9	45.6	39.5	40.84	46.3	52.7	49.9	501497-1610	501497-1600	160
62.9	55.6	49.5	50.84	56.3	62.7	59.9	501497-2010	501497-2000	200
72.9	65.6	59.5	60.84	66.3	72.7	69.9	501497-2410	501497-2400	240
C	D	E	F	G	H	J	TRAY PACKAGE	CONNECTOR	CIRCUIT
MATERIAL NO.									

REVISED EC NO: J2007-0487 DRWN: AYOYAGI 2006/09/07 CHKD: THARUYAMA 2006/11/01 APPR: NUKITA 2006/11/02	GENERAL TOLERANCES (UNLESS SPECIFIED)				DIMENSION STYLE MM ONLY		SCALE 2:1	DESIGN UNITS METRIC	THIRD ANGLE PROJECTION	
	10 UNDER		±0.2		DRAWN BY YKOBAYASHI	DATE 2004/10/27	TITLE 0.5 B TO B CONN. SHIELD TYPE REC. ASSY H=6			
	10 OVER 30 UNDER		±0.25		CHECKED BY HIRATA	DATE 2004/10/27	MATERIAL NO. SEE CHART			
	30 OVER		±0.3		APPROVED BY MSASAO	DATE 2004/10/27	DOCUMENT NO. SD-501497-001			
ANGULAR ±1 °				DRAFT WHERE APPLICABLE MUST REMAIN WITHIN DIMENSIONS		MATERIAL NO. SEE CHART		DOCUMENT NO. SD-501497-001		SHEET NO. 1 OF 2

10 9 8 7 6 5 4 3 2 1

F

F

E

E

D

D

C

C

B

B

A

A

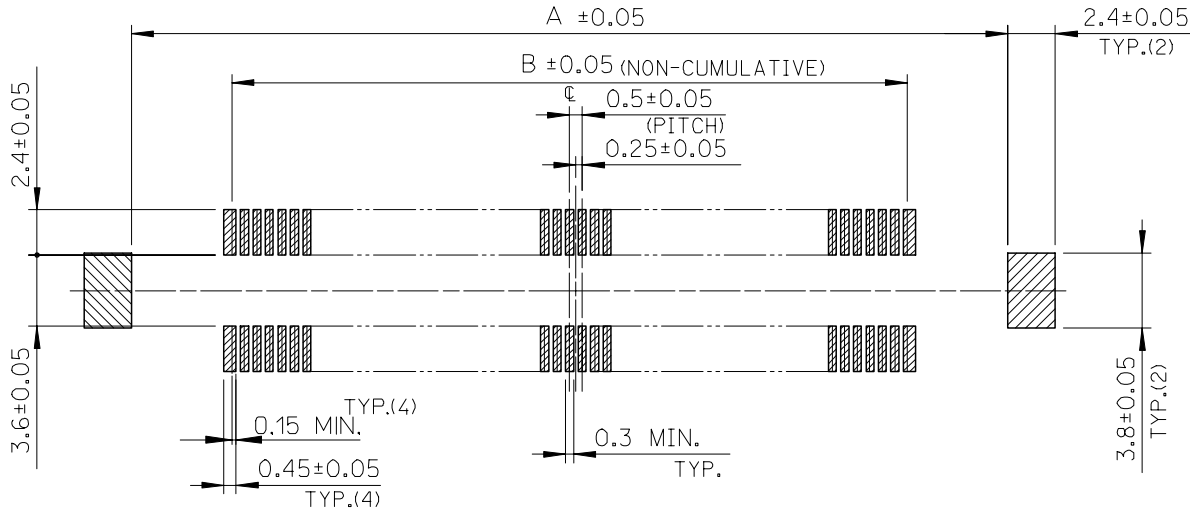

推奨基板レイアウト  
RECOMMENDED P.C.B LAYOUT

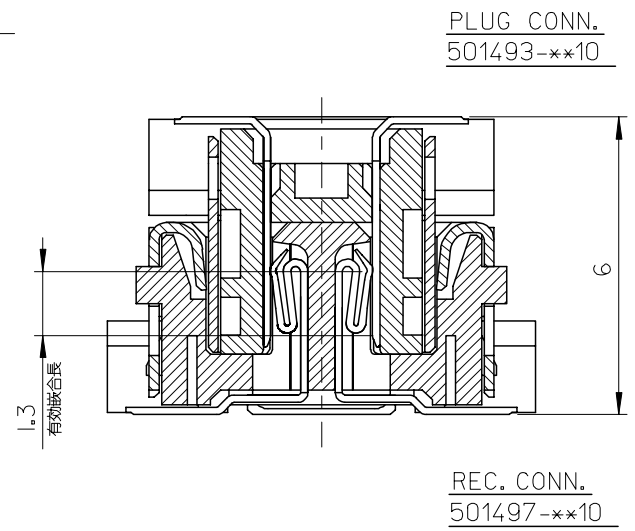

PLUG CONN.  
501493-\*\*10

REC. CONN.  
501497-\*\*10

49.2	39.5	501497-1610	160
59.2	49.5	501497-2010	200
69.2	59.5	501497-2410	240
A	B	TRAY PACKAGE	CIRCUIT

REVISED EC NO: J2007-0487 DRAWN: AOYAGI 2006/09/07 CHKD: THARUYAMA 2006/11/01 APPR: NUKITA 2006/11/02	GENERAL TOLERANCES (UNLESS SPECIFIED)		DIMENSION STYLE MM ONLY	SCALE ---	DESIGN UNITS METRIC	THIRD ANGLE PROJECTION
	10 UNDER	± 0.2	DRAWN BY YKOBAYASHI	DATE 2004/10/27	TITLE 0.5 B TO B CONN. SHIELD TYPE REC. ASSY H=6	
	10 OVER 30 UNDER	± 0.25	CHECKED BY HIRATA	DATE 2004/10/27	MOLEX INCORPORATED	
	30 OVER	± 0.3	APPROVED BY MSASAO	DATE 2004/10/27	DOCUMENT NO. SD-501497-001	
	ANGULAR ±1 °		MATERIAL NO.		SHEET NO. 2 OF 2	
	DRAFT WHERE APPLICABLE MUST REMAIN WITHIN DIMENSIONS		SIZE A3	THIS DRAWING CONTAINS INFORMATION THAT IS PROPRIETARY TO MOLEX INCORPORATED AND SHOULD NOT BE USED WITHOUT WRITTEN PERMISSION		

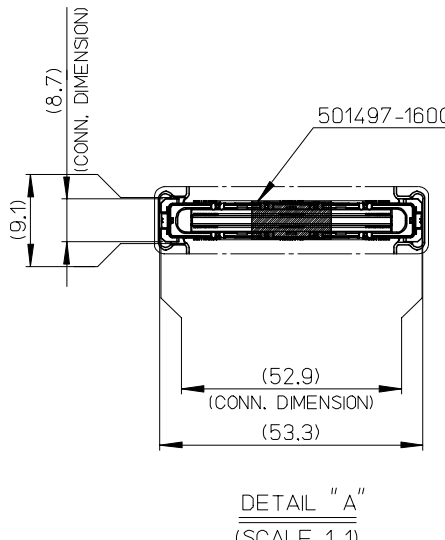
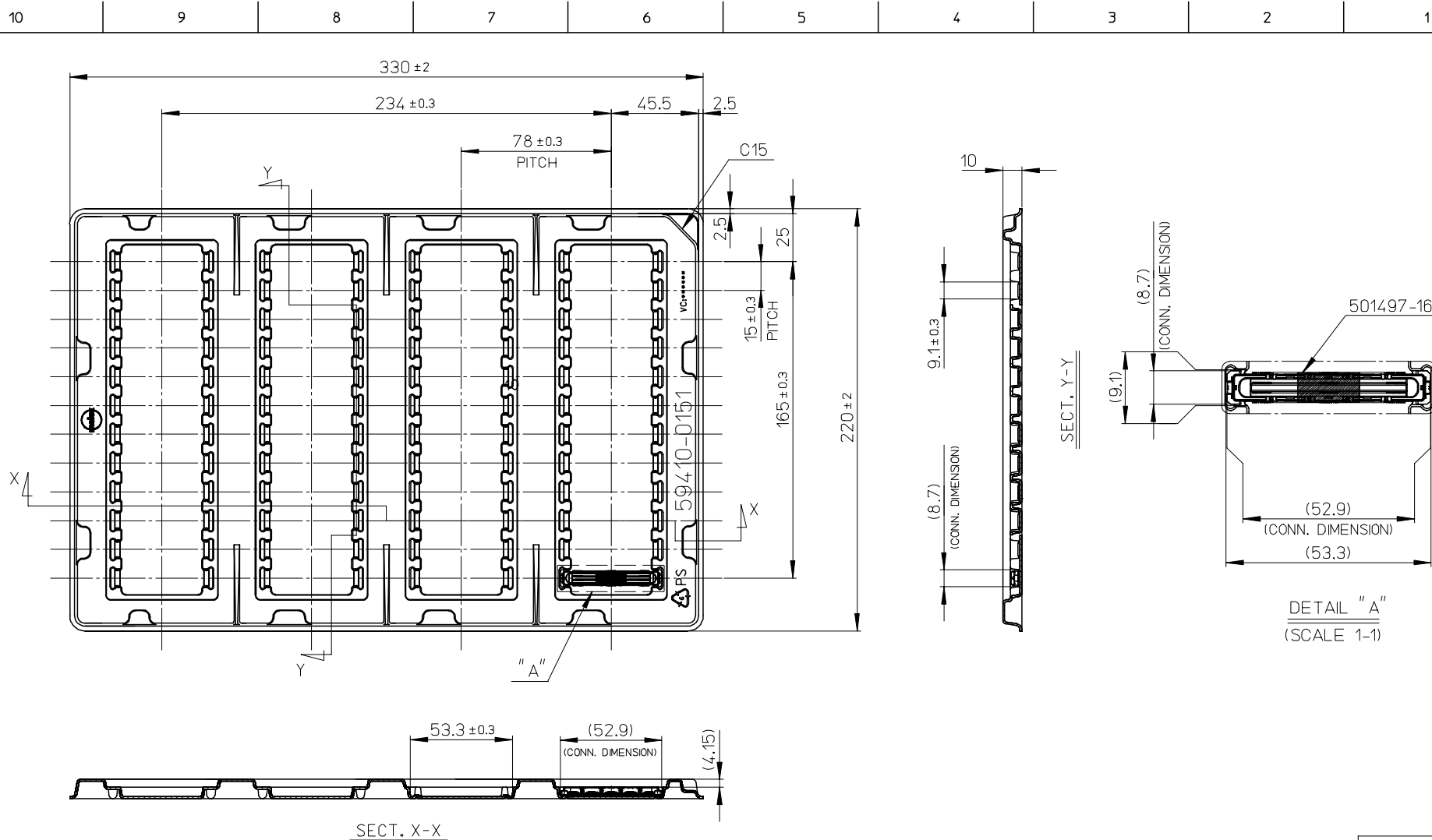

SECT. X-X

注記

1. 一般公差: ±0.5  
GENERAL TOLERANCES: ±0.5
2. 各部の反りは1.5MAX.  
WARP: 1.5MAX.
3. 梱包数: 48個  
PACKAGING QUANTITY: 48PCS.
4. 標準梱包数: 720個  
STANDARD PACKAGING QUANTITY: 720PCS.
5. トレイは180°反転させて重ねる。  
180 DEGREES IS REVERSED AND A TRAY IS PILED UP.

RELEASED EC NO: J2007-1260 DRWN: OTANI 2006/11/01 CHKD: MISOGAYA 2006/11/01 APPR: NUKITA 2006/11/01 REV 0	GENERAL TOLERANCES (UNLESS SPECIFIED)		DIMENSION STYLE MM ONLY	SCALE 1:2	DESIGN UNITS METRIC	THIRD ANGLE PROJECTION	
	10 UNDER ±0.2 10 OVER 30 UNDER ±0.25 30 OVER ±0.3	ANGULAR ±1°	DRAFT WHERE APPLICABLE MUST REMAIN WITHIN DIMENSIONS	DRAWN BY Y. OTANI	DATE 2006/10/31	TITLE TRAY FOR 501497-1610 (0.5 B TO B CONN. SHIELD TYPE REC. ASSY 160P H=6)	MOLEX INCORPORATED
				CHECKED BY M. ISOGAYA	DATE 2006/10/31		
				APPROVED BY N. UKITA	DATE 2006/10/31		
				MATERIAL NO. 594100151	DOCUMENT NO. SD-501497-004	SHEET NO. 1 OF 1	

501497-1610  
適用製品番号  
APPLICABLE PART No.