

10 9 8 7 6 5 4 3 2 1

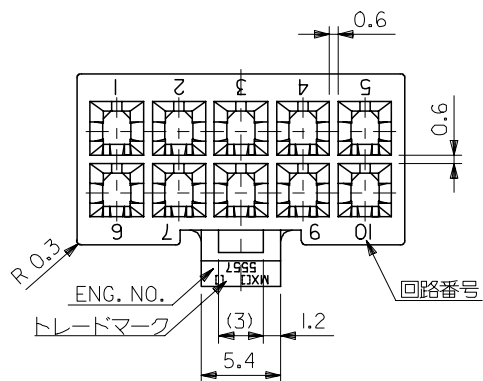

- 注記
- 適用ターミナル：5556 シリーズ
 - 嵌合相手：5559 シリーズ
5566 シリーズ
5569 シリーズ
501566 シリーズ
- △ D 面の位置にて維持すること。

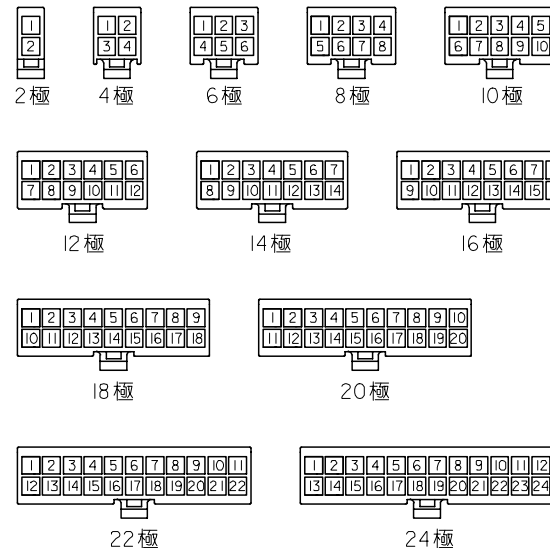

回路レイアウト図
(SCALE 1:1)

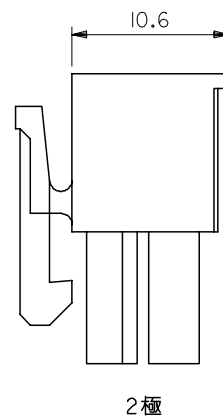
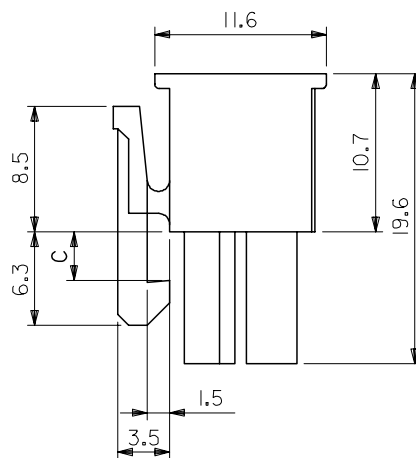
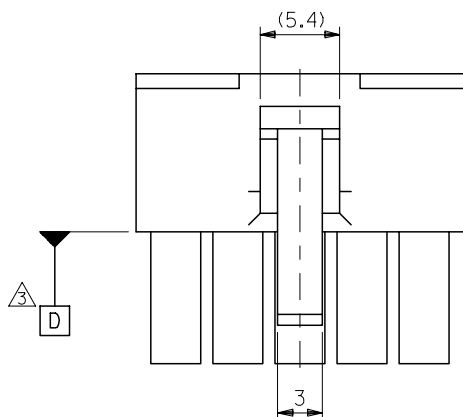

4~24極

材料 MATERIAL	66ナイロン (UL94V-2)	
仕上げ FINISH	—	
適用電線範囲 WIRE RANGE	—	
被覆外径 INS. RANGE	—	

C	B	A	EDP. NO.	ENG. NO.	極数
3.6	51.6	46.2	39-01-2240	5557-24R	24
	47.4	42	-2220	-22R	22
	43.2	37.8	-2200	-20R	20
3.3	39	33.6	-2180	-18R	18
	34.8	29.4	-2160	-16R	16
	30.6	25.2	-2140	-14R	14
	26.4	21	-2120	-12R	12
	22.2	16.8	-2100	-10R	10
	18	12.6	-2080	-08R	8
	13.8	8.4	-2060	-06R	6
	9.6	4.2	-2040	-04R	4
	5.4	—	39-01-2020	5557-02R	2

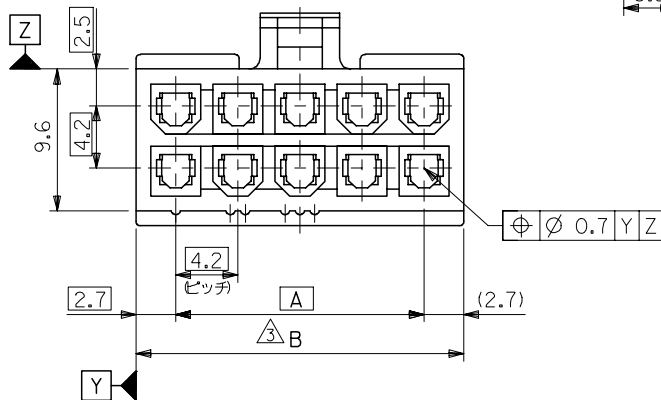

REVISED EC NO: J2005-3799 DRWN: NABE CHKD: TOYODA APPR: NUKITA	DESCRIPTION 2005/06/20 2005/06/21 2005/06/27	GENERAL TOLERANCES (UNLESS SPECIFIED)		DIMENSION STYLE MM ONLY		SCALE ---	DESIGN UNITS METRIC	THIRD ANGLE PROJECTION			
		10 UNDER ±0.2	10 OVER 30 UNDER ±0.3	30 OVER ±0.4	ANGULAR ±3 °	DRAFT WHERE APPLICABLE MUST REMAIN WITHIN DIMENSIONS	DRAWN BY DATE S. MOCHIZUKI '90/02/22		TITLE NEW MINI FIT CONN REC. HOUSING		
		APPROVED BY DATE M. FUKUSHIMA '97/01/08		MATERIAL NO. SEE CHART		DOCUMENT NO. SD-5557-003		SHEET NO. 1 OF 2		MOLEX INCORPORATED	
		SIZE A3		THIS DRAWING CONTAINS INFORMATION THAT IS PROPRIETARY TO MOLEX INCORPORATED AND SHOULD NOT BE USED WITHOUT WRITTEN PERMISSION							

10 9 8 7 6 5 4 3 2 1

NOTES

1. TERMINAL : 5556 SERIES
2. MATE WITH : 5559 SERIES
5566 SERIES
5569 SERIES
501566 SERIES
3. (METRIC) VALUES SHOWN GOVERN OVER ENGLISH CONVERSION VALUES.
△ TO BE MEASURED AT POSITION OF □ SURFACE.

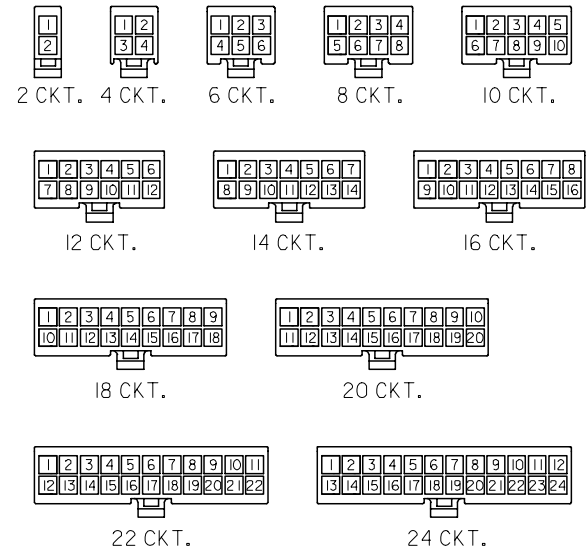

CIRCUIT SIZE LAYOUT
(SCALE 1:1)

(3.6) .142	(51.6) 2.031	(46.2) 1.819	39-01-2240	5557-24R	24
	(47.4) 1.866	(42) 1.654	↑ -2220	↑ -22R	22
(3.3) .129	(43.2) 1.701	(37.8) 1.488	-2200	-20R	20
	(39) 1.535	(33.6) 1.323	-2180	-18R	18
	(34.8) 1.37	(29.4) 1.158	-2160	-16R	16
	(30.6) 1.205	(25.2) .992	-2140	-14R	14
	(26.4) 1.039	(21) .827	-2120	-12R	12
	(22.2) .874	(16.8) .661	-2100	-10R	10
	(18) .709	(12.6) .496	-2080	-08R	8
	(13.8) .543	(8.4) .331	-2060	-06R	6
	(9.6) .378	(4.2) .165	↓ -2040	↓ -04R	4
	(5.4) .213	—	39-01-2020	5557-02R	2

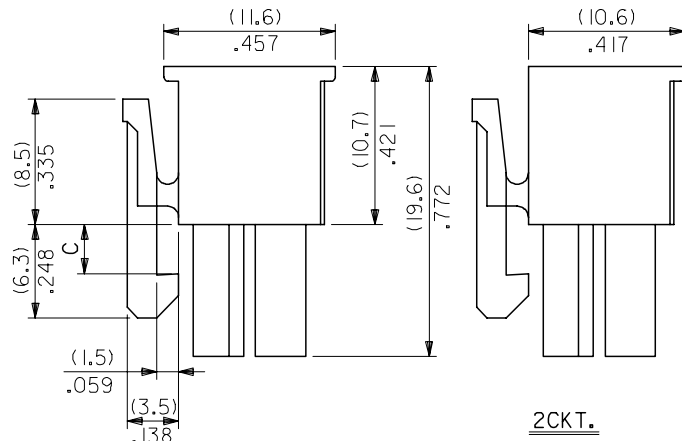
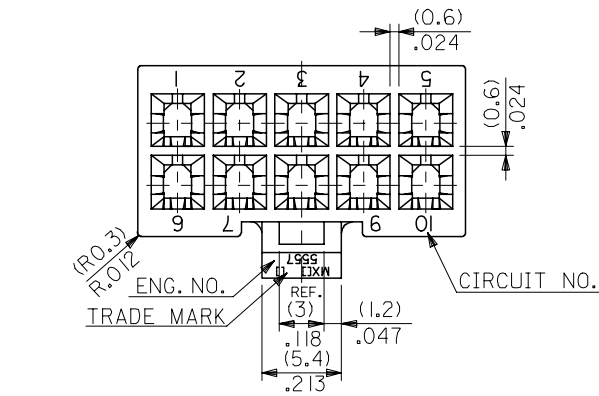

4~24CKT.

材料 MATERIAL	66NYLON (UL94V-2)
仕上り FINISH	—
適用電線範囲 WIRE RANGE	—
被覆外径 NS. RANGE	—

REVISED EC NO: J2005-3799 DRW: NABEI CHK: KATOYODA APP: NUKITA	DESCRIPTION 2005/06/20 2005/06/21 2005/06/27	GENERAL TOLERANCES (UNLESS SPECIFIED)		DIMENSION STYLE	SCALE	DESIGN UNITS	THIRD ANGLE PROJECTION	
		10 UNDER	±0.2	MM ONLY	3:1	METRIC	□	
		10 OVER 30 UNDER	±0.3	DRAWN BY DATE S. MOCHIZUKI '90/02/22		TITLE NEW MINI FIT CONN REC. HOUSING		
		30 OVER	±0.4	CHECKED BY DATE M. FUKUSHIMA '97/01/08		MOLEX INCORPORATED		
ANGULAR ±3 °		DRAFT WHERE APPLICABLE MUST REMAIN WITHIN DIMENSIONS		APPROVED BY DATE M. FUKUSHIMA '97/01/08		DOCUMENT NO. SD-5557-003		
SIZE A3		THIS DRAWING CONTAINS INFORMATION THAT IS PROPRIETARY TO MOLEX INCORPORATED AND SHOULD NOT BE USED WITHOUT WRITTEN PERMISSION		MATERIAL NO. SEE CHART		SHEET NO. 2 OF 2		

