

FEATURES

- Industry standard footprint
- Single isolated output
- Short circuit protection
- Operating temperature range -40°C to $+85^{\circ}\text{C}$
- Low profile 24 pin case
- 2:1 Wide input range
- 1kVDC Isolation 'Hi Pot Test'
- 5V, 12V, 24V & 48V Input
- 3.3V, 5V, 12V & 15V Output
- Internal SMD construction
- Fully encapsulated

DESCRIPTION

The NDTS series is a range of low profile DC/DC converters offering a single regulated output over a 2:1 input voltage range. All parts deliver 3W output power up to 85°C without heatsinking. A flyback oscillator design with isolated feedback is used to give regulation over the full operating range of 25% to 100% of full load. It is strongly recommended that external capacitors be used on input and output to guarantee performance over full load and input voltage range (see recommended filter circuit for values).



For full details go to www.murata-ps.com/rohs

SELECTION GUIDE

Order code	Input voltage V (Nom.)	Rated output voltage V	Output current		Input current full load mA	Efficiency (Min.) %	Isolation capacitance pF	MTTF ² kHrs	
			Min. Load ¹ mA	Full load mA					
			Recommended		In Production				
NDTS0503C	5	3.3	227	909	898	63	28	1658	
NDTS0505C	5	5	150	600	806	71	30	1665	
NDTS0512C	5	12	63	250	769	76	32	1650	
NDTS1212C	12	12	63	250	310	75	35	1650	
NDTS2403C	24	3.3	227	909	172	71	32	1671	
NDTS2405C	24	5	150	600	156	78	32	1673	
NDTS2412C	24	12	63	250	149	80	35	1650	
									Recommended Alternative
To Be Discontinued									
NDTS0515C	5	15	50	200	757	77	33	1633	NDY0515C
NDTS1203C	12	3.3	227	909	350	71	29	1668	NCS3S1203SC
NDTS1205C	12	5	150	600	320	73	32	1665	NDY1205C
NDTS1215C	12	15	50	200	310	76	32	1633	NDY1215C
NDTS2415C	24	15	50	200	147	84	35	1617	NDY2415C
NDTS4803C	48	3.3	227	909	87	71	32	1676	NCS3S4803SC
NDTS4805C	48	5	150	600	83	75	32	1668	NDY4805C
NDTS4812C	48	12	63	250	76	80	40	1631	NCS3S4812SC
NDTS4815C	48	15	50	200	75	80	40	1600	NCS3S4815SC

INPUT CHARACTERISTICS

Parameter	Conditions	Min.	Typ.	Max.	Units
Voltage range	All NDTS05 types	4.5	5	9	V
	All NDTS12 types	9	12	18	
	All NDTS24 types	18	24	36	
	All NDTS48 types	36	48	72	
Reflected ripple current ¹	All NDTS05 types		50	150	mA p-p
	All NDTS12 types		30	100	
	All NDTS24 types		40	50	
	All NDTS48 types		30	40	

OUTPUT CHARACTERISTICS

Parameter	Conditions	Min.	Typ.	Max.	Units
Voltage set point accuracy	With external input/output capacitors		± 1	± 3	%
Line regulation	Low line to high line with external input/output capacitors		0.15	0.5	%
Load regulation	Minimum load to rated load with external input/output capacitors	0503, 0505, 1203, 1205	0.8	1.0	%
		2403, 2405, 4803, 4805	0.8	1.2	
		12V & 15V outputs	0.1	0.5	
Ripple	BW = 20Hz to 300kHz with external input/output capacitors		15	40	mV rms
Ripple & noise	BW = DC to 20MHz with external input/output capacitors		90	150	mV p-p

1. Please refer to selected ripple current measurement circuit on page 2.

2. Calculated using MIL-HDBK-217F with nominal input voltage at full load (ground benign) at 25°C .

All specifications typical at $T_A = 25^{\circ}\text{C}$, nominal input voltage and rated output current unless otherwise specified.

ABSOLUTE MAXIMUM RATINGS

Short-circuit protection	8 Hours
Lead temperature 1.5mm from case for 10 seconds	300°C
Minimum output load for specification ¹	25% of rated output
Input voltage 05 types	10V
Input voltage 12 types	20V
Input voltage 24 types	40V
Input voltage 48 types	80V
Free air space	10mm Min. around component

GENERAL CHARACTERISTICS

Parameter	Conditions	Min.	Typ.	Max.	Units
Switching frequency	100% to 25% load, V_{IN} Min. to Max.	70		650	kHz

ISOLATION CHARACTERISTICS

Parameter	Conditions	Min.	Typ.	Max.	Units
Isolation voltage	Flash tested for 1 second	1000			VDC
Resistance	Resistance	1			GΩ

TEMPERATURE CHARACTERISTICS

Parameter	Conditions	Min.	Typ.	Max.	Units
Operation		-40		85	°C
Storage		-50		125	
Case temperature rise above ambient in still air	NDTS0515C, NDTS1205C, NDTS1212C, NDTS1215C, NDTS2405C, NDTS2412C, NDTS2415C, NDTS4812C & NDTS4815C		30		
	NDTS0505C, NDTS0512C, NDTS1203C, NDTS2403C, NDTS4803C & NDTS4805C		40		
	NDTS0503C		50		

TECHNICAL NOTES

ISOLATION VOLTAGE

'Hi Pot Test', 'Flash Tested', 'Withstand Voltage', 'Proof Voltage', 'Dielectric Withstand Voltage' & 'Isolation Test Voltage' are all terms that relate to the same thing, a test voltage, applied for a specified time, across a component designed to provide electrical isolation, to verify the integrity of that isolation.

Murata Power Solutions NDTS series of DC/DC converters are all 100% production tested at their stated isolation voltage. This is 1kVDC for 1 second.

A question commonly asked is, "What is the continuous voltage that can be applied across the part in normal operation?"

For a part holding no specific agency approvals, such as the NDTS series, both input and output should normally be maintained within SELV limits i.e. less than 42.4V peak, or 60VDC. The isolation test voltage represents a measure of immunity to transient voltages and the part should never be used as an element of a safety isolation system. The part could be expected to function correctly with several hundred volts offset applied continuously across the isolation barrier; but then the circuitry on both sides of the barrier must be regarded as operating at an unsafe voltage and further isolation/insulation systems must form a barrier between these circuits and any user-accessible circuitry according to safety standard requirements.

REPEATED HIGH-VOLTAGE ISOLATION TESTING

It is well known that repeated high-voltage isolation testing of a barrier component can actually degrade isolation capability, to a lesser or greater degree depending on materials, construction and environment. The NDTS series has an EI ferrite core, with no additional insulation between primary and secondary windings of enameled wire. While parts can be expected to withstand several times the stated test voltage, the isolation capability does depend on the wire insulation. Any material, including this enamel (typically polyurethane) is susceptible to eventual chemical degradation when subject to very high applied voltages thus implying that the number of tests should be strictly limited. We therefore strongly advise against repeated high voltage isolation testing, but if it is absolutely required, that the voltage be reduced by 20% from specified test voltage.

This consideration equally applies to agency recognized parts rated for better than functional isolation where the wire enamel insulation is always supplemented by a further insulation system of physical spacing or barriers.

RoHS COMPLIANCE INFORMATION



This series is compatible with RoHS soldering systems with a peak wave solder temperature of 300°C for 10 seconds. The pin termination finish on this product series is Tin. The series is backward compatible with Sn/Pb soldering systems. For further information, please visit www.murata-ps.com/rohs

1. Please refer to minimum load application note on page 4.

APPLICATION NOTES

Recommended Input & Output Capacitors

Although these converters will work without external capacitors, they are necessary in order to guarantee the full parametric performance over the full line and load range. All parts have been tested and characterized using the following values and test circuit.

Input Voltage	C _{IN}	Output Voltage	C _{OUT}
5V, 12V	100µF, 25V (0.25Ω at 100kHz)	3.3V, 5V	220µF, 16V (0.12Ω at 100kHz)
24V, 48V	10µF, 100V (1.5Ω at 100kHz)	12V, 15V	100µF, 25V (0.25Ω at 100kHz)

Test circuit

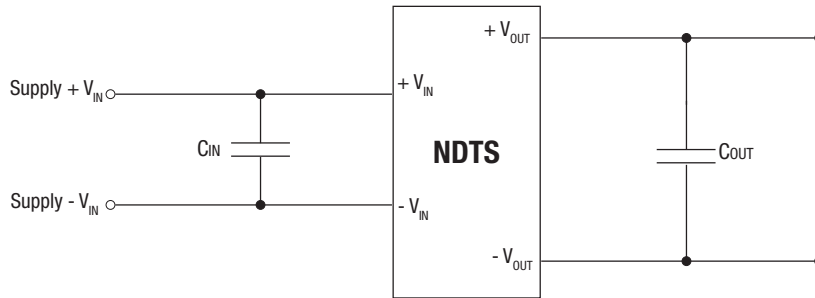

Reflected Ripple Current Measurement

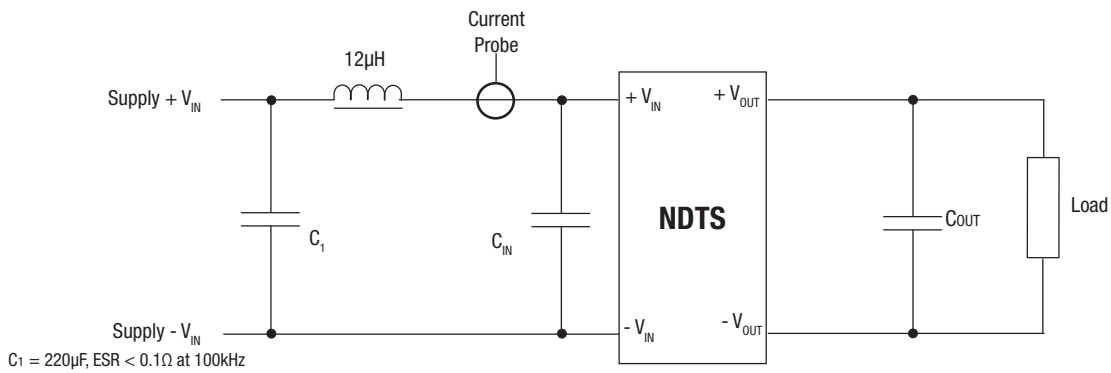

APPLICATION NOTES (continued)

Minimum Load

The minimum load for correct operation is 25% of the full rated load across the specified input voltage range. Lower loads may cause a significant increase in output ripple and may cause the output voltage to exceed its specification transiently during power-down when the input voltage also falls below its rated minimum.

The following graphs show the typical required minimum load required for stable operation in mA versus input voltage. Some variants are not included as they do not typically require a minimum load for stable operation: NDTD1212C, and NDTD1215C.

The NDTS series will operate from a wider input range than specified in the input characteristics datasheet table with output power derating. Please contact Murata Power Solutions for further information.

NDTS05XXC

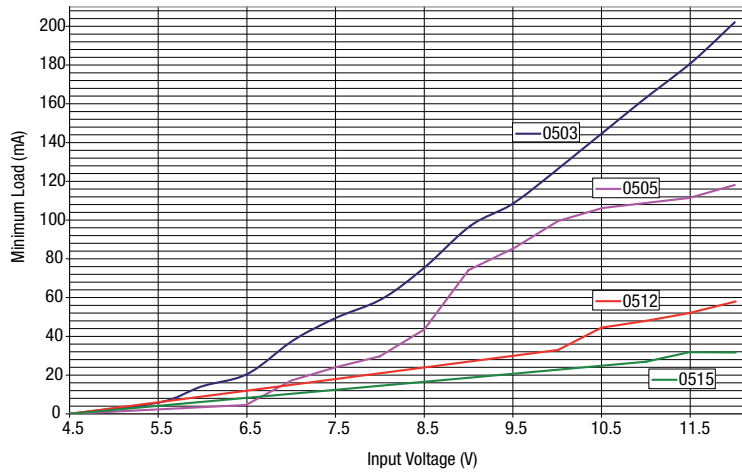

NDTS12XXC

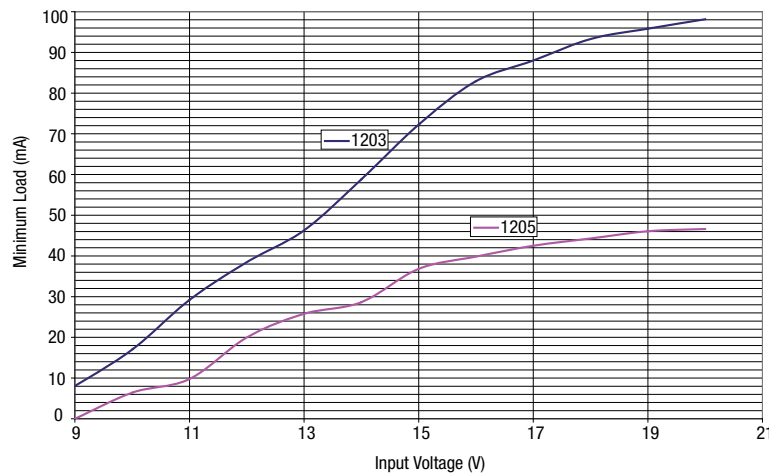

APPLICATION NOTES (continued)

NDTS24XXC

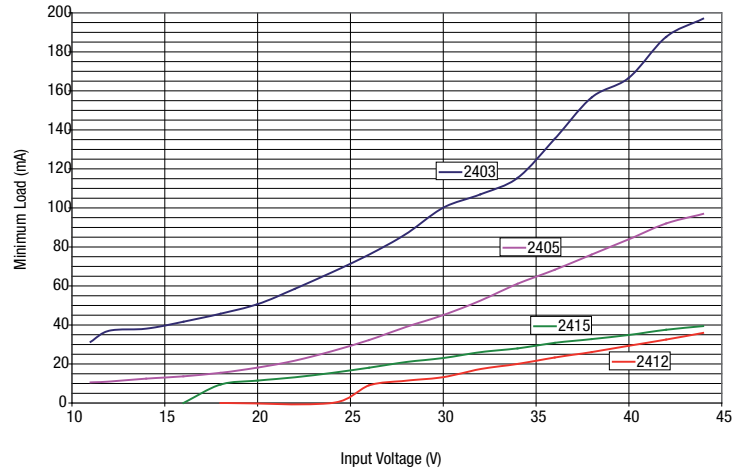

NDTS48XXC

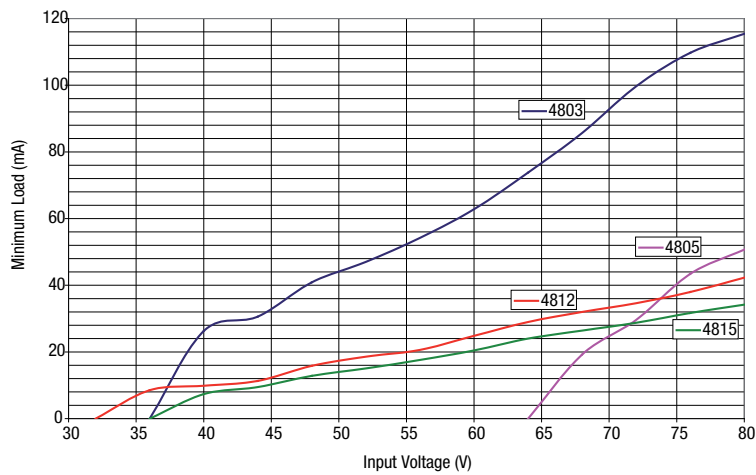

PACKAGE SPECIFICATIONS

MECHANICAL DIMENSIONS

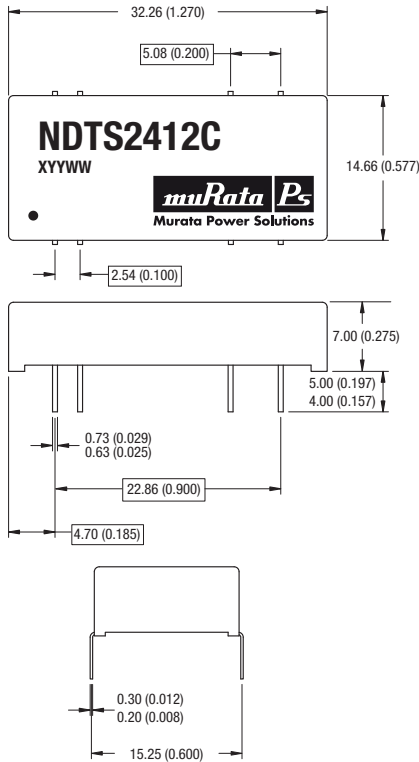

All dimensions in mm(inches) $\pm 0.25(0.010)$.
All pins on a 2.54(0.10") pitch and within $\pm 0.25(0.010)$ " of true position.

Weight: 6.2g

TUBE OUTLINE DIMENSIONS

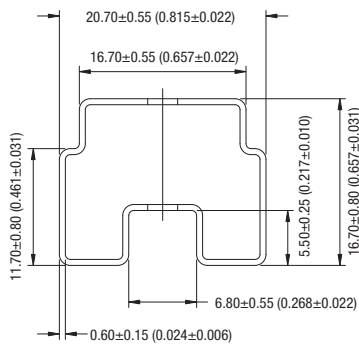

All dimensions in mm (inches) $\pm 0.5\text{mm}$ (0.20").
Tube length : 520mm $\pm 2\text{mm}$ (20.47 ± 0.079 ").

Tube Quantity : 15

PIN CONNECTIONS

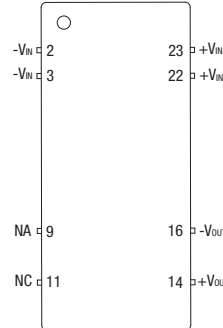

Pin	Function
2	-VIN
3	-VIN
9	NA
11	NC
14	+VOUT
16	-VOUT
22	+VIN
23	+VIN

NA - Not available for electrical connection.
NC - No internal connection.

RECOMMENDED FOOTPRINT DETAILS

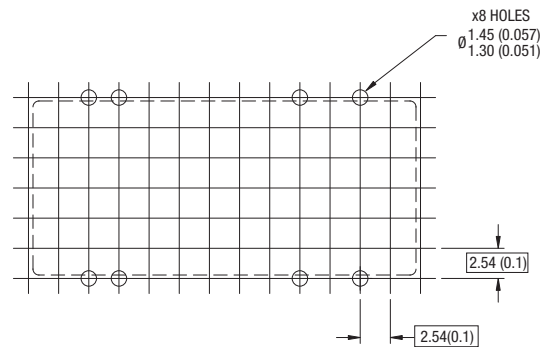

All dimensions in mm(inches) $\pm 0.25(0.010)$ ". All pins on a 2.54(0.10") pitch and within $\pm 0.25(0.010)$ " of true position.

Murata Power Solutions, Inc.
11 Cabot Boulevard, Mansfield, MA 02048-1151 U.S.A.
ISO 9001 and 14001 REGISTERED



This product is subject to the following **operating requirements** and the **Life and Safety Critical Application Sales Policy**:
Refer to: <http://www.murata-ps.com/requirements/>

Murata Power Solutions, Inc. makes no representation that the use of its products in the circuits described herein, or the use of other technical information contained herein, will not infringe upon existing or future patent rights. The descriptions contained herein do not imply the granting of licenses to make, use, or sell equipment constructed in accordance therewith. Specifications are subject to change without notice.
© 2017 Murata Power Solutions, Inc.