

Search by Part Number

Search by Specifications

Search in the Lineups

Search by Competitor's Part Number

Home > Products > Capacitors > Ceramic Capacitors > Product details  

Chip Monolithic Ceramic Capacitors for General Purpose

▶ Please be sure to read here, before using a product. ▶ Cautions about imitations

GRM188C80J475KE15#

"#" indicates a package specification code.

In Production  [Smaller items available](#)











< List of part numbers with package codes >
 GRM188C80J475KE15D、GRM188C80J475KE15J

Shape

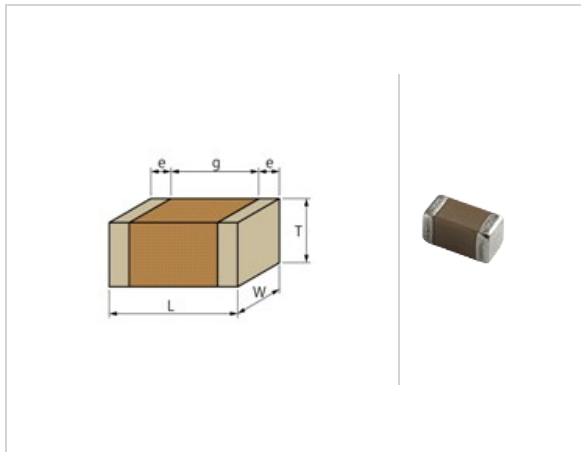

L size	1.6 ±0.1mm
W size	0.8 ±0.1mm
T size	0.8 ±0.1mm
External terminal width e	0.2 to 0.5mm
Distance between external terminals g	0.5mm min.
Size code in inch(mm)	0603 (1608M)

Specifications

Capacitance	4.7µF ±10%
Rated voltage	6.3Vdc
Temperature characteristics (complied standard)	X6S(EIA)
Capacitance change rate	±22.0%
Temperature range of temperature characteristics	-55 to 105°C
Operating temperature range	-55 to 105°C

Notes

Derating1

References

Packaging	Specifications	Minimum quantity
D	φ180mm Paper taping	4000

[Stock Check \(Where to buy\)](#) 

[PDF Catalogs](#)

[Download a PDF file of this page](#) 

[How to read part numbers](#) 

[Series Information](#) 

Specifications

[Detailed specifications sheet](#) 

- Rated value
- Specifications and Test methods
- Package
- Caution, Notice (Storage, Soldering and Mounting, ...etc.)

Product data

[SPICE Netlist \(mod type\)](#) 

[S parameter \(S2P type\)](#) 



[Reliability test data \(Typical data\)](#) 

Packaging	Specifications	Minimum quantity
J	φ330mm Paper taping	10000

Mass (typ.)	
1 piece	6.3mg
φ180mm Reel	144g

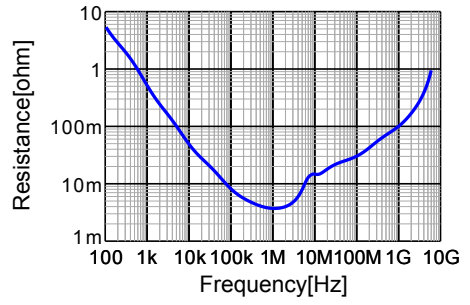
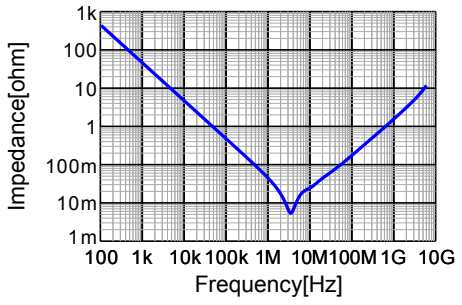
Chart of characteristic data



 [Go to the detailed chart](#) 

[Top of page](#)