

Search by Part Number

Search by Specifications

Search in the Lineups

Search by Competitor's Part Number

Home > Products > Capacitors > Ceramic Capacitors > Product details  

Chip Monolithic Ceramic Capacitors for General Purpose

▶ Please be sure to read here, before using a product. ▶ Cautions about imitations

GRM31CR60J107ME39#

"#" indicates a package specification code.

Recommended In Production  [▶ Smaller items available](#)

General **85**   **RoHS** **REACH** 

< List of part numbers with package codes >
GRM31CR60J107ME39L

Shape

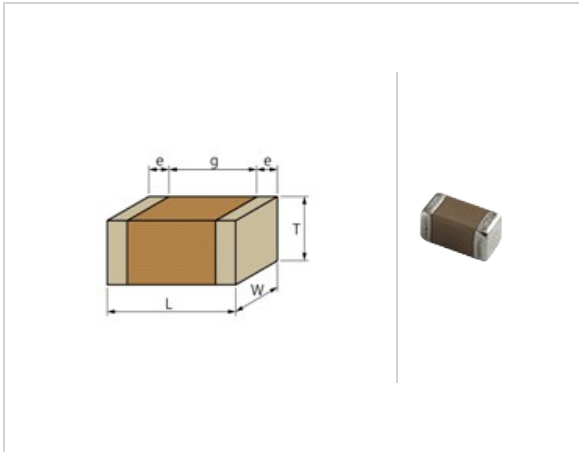

L size	3.2 ±0.3mm
W size	1.6 ±0.3mm
T size	1.6 ±0.3mm
External terminal width e	0.3 to 0.8mm
Distance between external terminals g	1.5mm min.
Size code in inch(mm)	1206 (3216M)

Specifications

Capacitance	100µF ±20%
Rated voltage	6.3Vdc
Temperature characteristics (complied standard)	X5R(EIA)
Capacitance change rate	±15.0%
Temperature range of temperature characteristics	-55 to 85°C
Operating temperature range	-55 to 85°C

References

Packaging	Specifications	Minimum quantity
L	φ180mm Embossed taping	2000

Mass (typ.)	
1 piece	64mg
φ180mm Reel	169g

20pcs free sample request 

Stock Check (Where to buy) 

PDF Catalogs

Download a PDF file of this page 

How to read part numbers 

Series Information 

Specifications

Detailed specifications sheet 

- Rated value
- Specifications and Test methods
- Package
- Caution, Notice (Storage, Soldering and Mounting, ...etc.)

Product data

SPICE Netlist (mod type) 

S parameter (S2P type) 

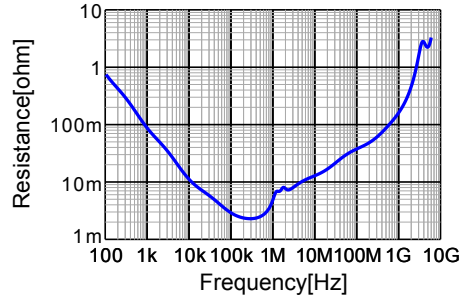
Reliability test data (Typical data) 

Chart of characteristic data

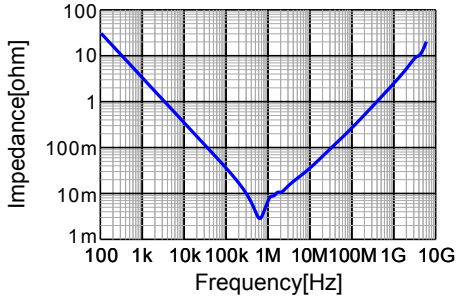

 [Go to the detailed chart](#) 

[Top of page](#)