

GRM21BR71A106KA73#

" # " indicates a package specification code.

Available   Complies with RoHS 

< List of part numbers with package codes >
GRM21BR71A106KA73L , GRM21BR71A106KA73K

Shape

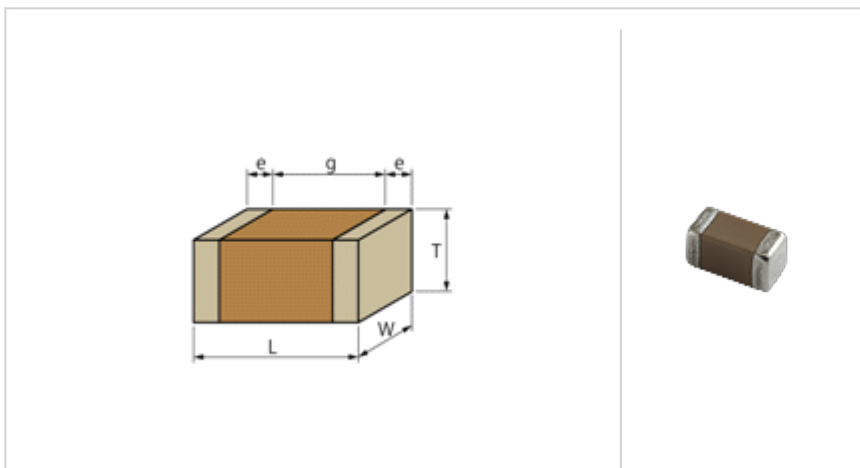

L size	2.0 ± 0.15mm
W size	1.25 ± 0.15mm
T size	1.25 ± 0.15mm
External terminal width e	0.2 to 0.7mm
Distance between external terminals g	0.7mm min.
Size code in inch(mm)	0805 (2012)

Notes

Volt. & temp. derating recommended product

References

Packaging	Specifications	Minimum quantity
L	180mm Embossed taping	3000
K	330mm Embossed taping	10000

Mass (typ.)	
1 piece	19mg
180mm Reel	108g

Specifications

Capacitance	10µF ± 10%
Rated voltage	10Vdc
Temperature characteristics (complied standard)	X7R(EIA)
Capacitance change rate	± 15.0%
Temperature range of temperature characteristics	-55 to 125
Operating temperature range	-55 to 125

Attention

- 1.This datasheet is downloaded from the website of Murata Manufacturing Co., Ltd. Therefore, it ' s specifications are subject to change or our products in it may be discontinued without advance notice. Please check with our sales representatives or product engineers before ordering.
- 2.This datasheet has only typical specifications because there is no space for detailed specifications. Therefore, please review our product specifications or consult the approval sheet for product specifications before ordering.

▪ Frequency characteristics (ESR, Impedance)

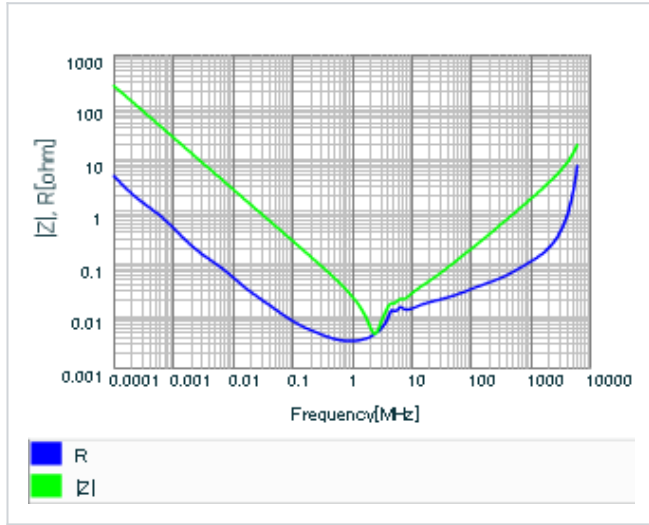

▪ S parameter (Smith chart S11)

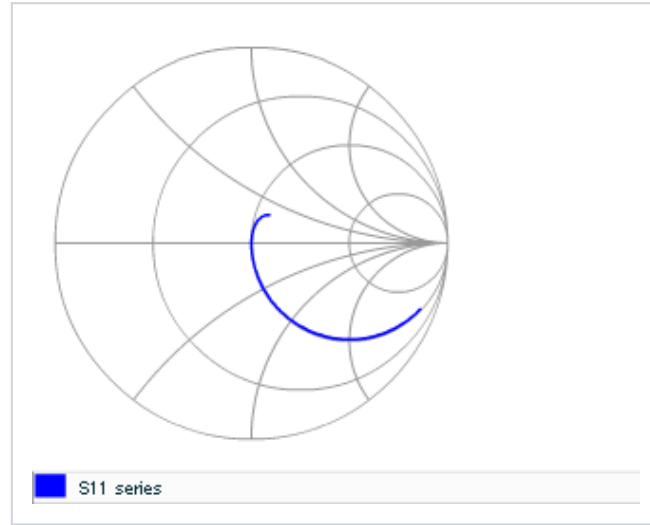

▪ DC bias characteristics

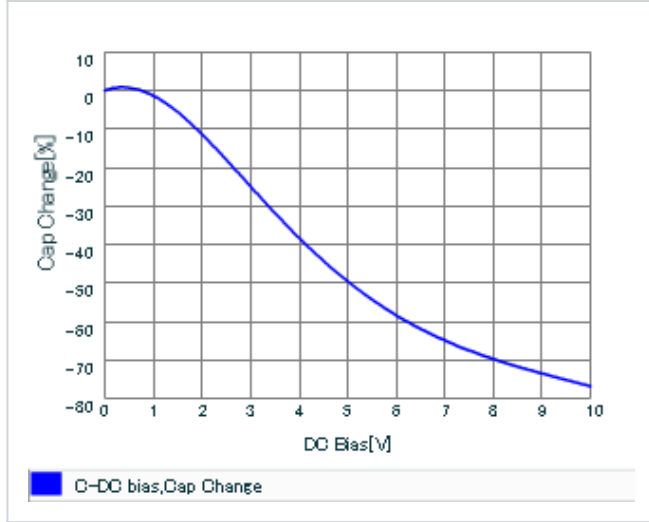

▪ AC voltage characteristics

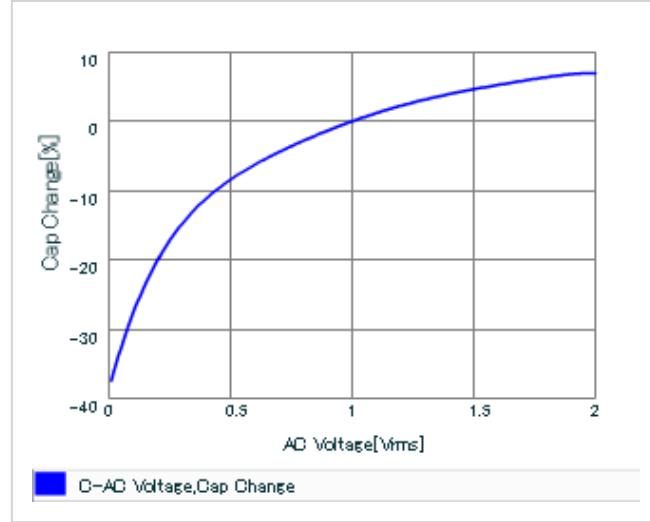

▪ Capacitance - temperature characteristics

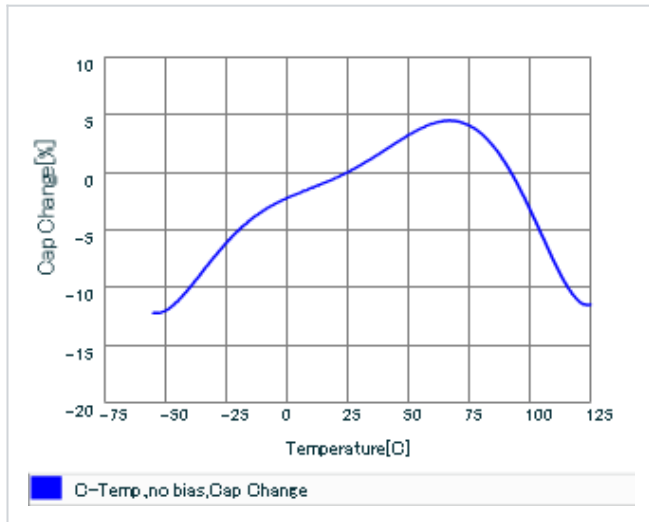

▪ Calorific property by ripple current

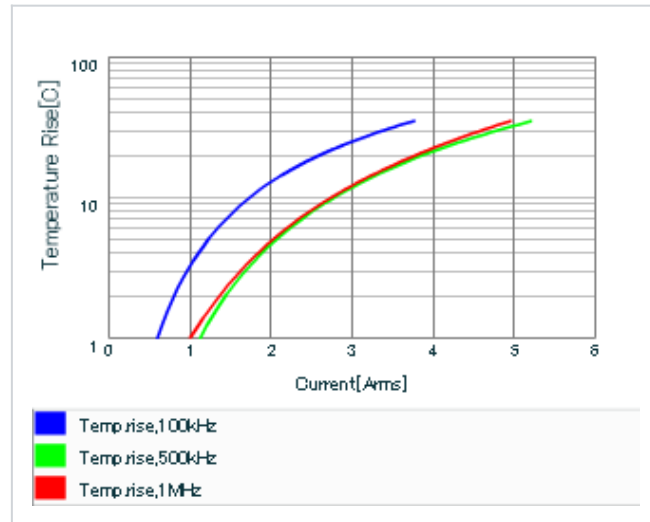

This PDF data has only typical specifications because there is no space for detailed specifications. Therefore, please review our product specifications or consult the approval sheet for product specifications before ordering.