

GA355QR7GF222KW01#

"#" indicates a package specification code.



< List of part numbers with package codes >
GA355QR7GF222KW01L

Shape

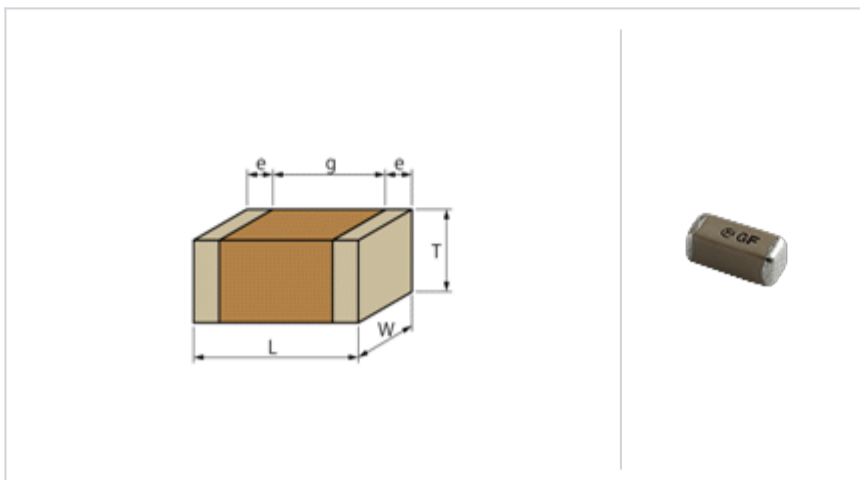

L size	5.7 ± 0.4mm
W size	5.0 ± 0.4mm
T size	1.5 +0/-0.3mm
External terminal width e	0.3mm min.
Distance between external terminals g	4.0mm
Size code in inch(mm)	2220 (5750)

Specifications

Capacitance	2200pF ± 10%
Rated voltage	250Vac(r.m.s.)
Temperature characteristics (complied standard)	X7R(EIA)
Capacitance change rate	± 15%
Temperature range of temperature characteristics	-55 to 125
Operating temperature range	-55 to 125

Notes

X1/Y2 Class Certified Products

References

Packaging	Specifications	Minimum quantity
L	180mm Embossed taping	1000

⚠ Attention

- 1.This datasheet is downloaded from the website of Murata Manufacturing Co., Ltd. Therefore, it ' s specifications are subject to change or our products in it may be discontinued without advance notice. Please check with our sales representatives or product engineers before ordering.
- 2.This datasheet has only typical specifications because there is no space for detailed specifications. Therefore, please review our product specifications or consult the approval sheet for product specifications before ordering.