



GCM216R71H103KA37#

"#" indicates a package specification code.

Available   Complies with RoHS 

< List of part numbers with package codes >
GCM216R71H103KA37D , GCM216R71H103KA37J

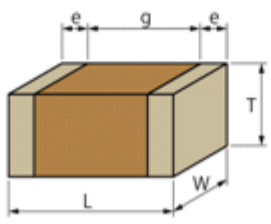
Shape

L size	2.0 ± 0.15mm
W size	1.25 ± 0.15mm
T size	0.6 ± 0.1mm
External terminal width e	0.2 to 0.7mm
Distance between external terminals g	0.7mm min.
Size code in inch(mm)	0805 (2012)

References

Packaging	Specifications	Minimum quantity
D	180mm Paper taping	4000
J	330mm Paper taping	10000

Mass (typ.)	
1 piece	9.6mg
180mm Reel	142g

Specifications

Capacitance	10000pF ± 10%
Rated voltage	50Vdc
Temperature characteristics (complied standard)	X7R(EIA)
Capacitance change rate	± 15.0%
Temperature range of temperature characteristics	-55 to 125
Operating temperature range	-55 to 125

Attention

- 1.This datasheet is downloaded from the website of Murata Manufacturing Co., Ltd. Therefore, it ' s specifications are subject to change or our products in it may be discontinued without advance notice. Please check with our sales representatives or product engineers before ordering.
- 2.This datasheet has only typical specifications because there is no space for detailed specifications. Therefore, please review our product specifications or consult the approval sheet for product specifications before ordering.