

Passive high precision isolated transmitter

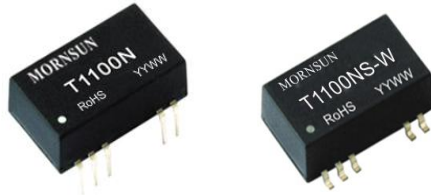

FEATURES

- Two-port isolation (signal input and signal output)
- High precision (0.1% Full Scale)
- High linearity (0.1% Full Scale)
- Isolation test voltage 3kVDC for 60s
- Extremely low temperature coefficient of 35PPM/°C
- Industrial grade (Operating ambient temperature range -25°C to +71°C)
- High reliability with MTBF >500,000 hours
- Low voltage-drop of 3V typical at 20mA input
- EN60950 safety approval

T1100N/NS series are passive signal isolation modules with a standard analog amplifier, 4-20mA current signal input and 4-20mA current signal output. This accurate isolated voltage signal to 4-20mA current conversion can be used in a variety of analog instrument input ports such as PLC and DCS systems, or similar. In addition, this module has extremely small SIP9 form factor with excellent temperature drift characteristics of less than 35PPM / °C across the entire -25°C to +71°C operating temperature range. This module adopts unique electromagnetic isolation mode that allows it to withstand 3kVDC isolation test voltage between input and output.

Selection Guide

Certification	Part No.	Power Supply input(VDC)	Input Signal	Output Signal	Isolated Power Output (VDC)
CE	T1100N	None	4-20mA	4-20mA	None
	T1100NS-W	None	4-20mA	4-20mA	None

Input Specifications

Item	Operating Conditions	Value
Power Supply Input	Power supply	None
	Input power	None
	Power supply protection	None
	Input signal	4-20mA
Signal Input	Maximum continuous over range	≤50mA
	Voltage drop-out @20mA	3V (Typ.)

Output Specifications

Item	Operating Conditions	Value
Signal Output	Output signal	4-20mA
	Load capacity @20mA	≤300Ω
	Load regulation	<0.05% meas.val./100Ω

Transmission Specifications

Item	Operating Conditions	Value
Zero Offset		0.1%FS
Signal Precision		0.1%FS
Temperature Coefficient	Operating temperature range: -25°C to +71°C	0.0035%FS/°C

General Specifications

Item	Operating Conditions	Value
Electric Isolation		Two-port isolation (signal input and signal output)
Isolation Test	Electric strength test for 1 minute with a leakage current of <1mA, humidity <70%RH	3kVDC
Insulation Resistance	At 500VDC (signal input and signal output)	100MΩ
Operating Temperature		-25°C to +71°C
Transportation and Storage Temperature		-50°C to +105°C

Soldering Temperature*	Wave-soldering	260±5°C; time: 5-10s
	Manual-welding	360±10°C; time: 3-5s
	Reflow-soldering	Peak temp. ≤245°C, maximum duration ≤60s at 217°C. Please also refer to IPC/JEDEC J-STD-020D.1.
Safety Standard		EN60950
Safety Certification		EN60950
Safety Class		CLASS III
Application Environment		The presence of dust, severe vibration, shock and corrosive gas may cause damage to the product
Moisture Sensitivity Level (MSL)	IPC/JEDEC J-STD-020D.1	Level 1
Note: * T1100NS model cannot be used for reflow soldering (internal temperature gets too high); T1100NS-W model can be used for reflow soldering.		

Mechanical Specifications

Case Material	Black plastic, flame-retardant heat-resistant
Package	DIP16/SOIC16
Weight	T1100NS-W: 3.1g(Typ.); T1100N: 4.7g(Typ.)
Cooling Method	Free air convection

Application Precautions

1. Carefully read and follow the instructions before use; contact our technical support if you have any question;
2. Do not use the product in hazardous areas;
3. Use only DC power supply source for this product and 220V AC power supply is prohibited;
4. It is strictly forbidden to disassemble the product privately in order to avoid product failure or malfunction.
5. T1100NS product does not withstand reflow soldering.

After-sales service

1. Factory inspection and quality control are strictly enforced before shipping any product; please contact your local representative or our technical support if you experience any abnormal operation or possible failure of the module;
2. The products have a 3-year warranty period, from the date of shipment. The product will be repaired or exchanged free of charge within the warranty period for any quality problem that occurs under normal use.

Applied circuit

See *Application Notes for Isolated Transmitter* for details.

Design Reference

1. Schematic diagram

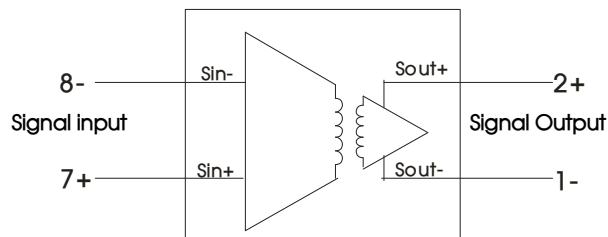

2. Schematic diagram of signal input and signal output (Ideal state)

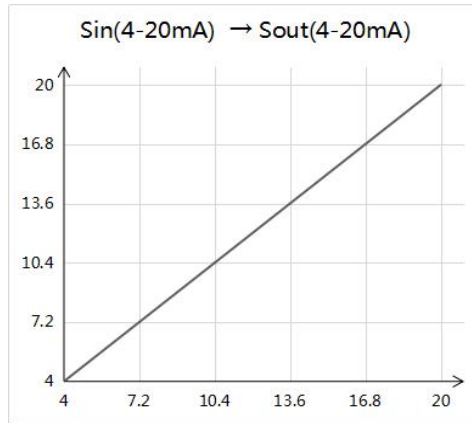

3. Wiring diagram

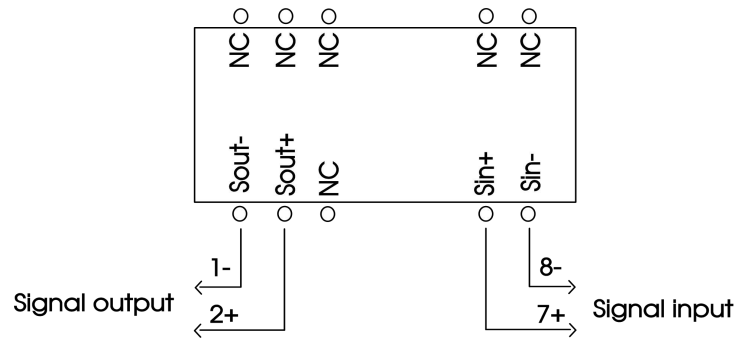

4. For additional information please find the application notes on www.mornsun-power.com

Dimensions and Recommended Layout

THIRD ANGLE PROJECTION

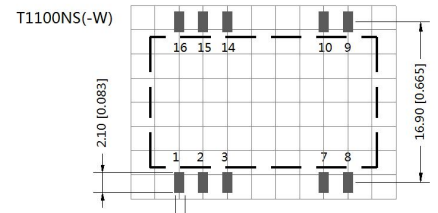
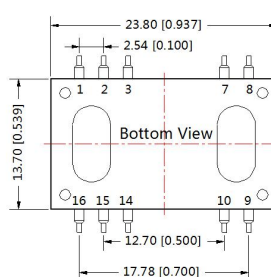
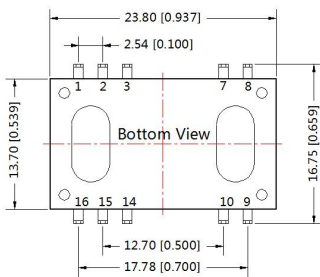
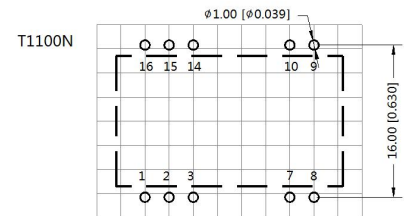
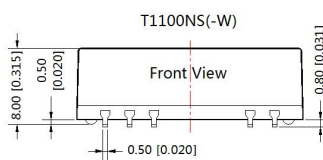
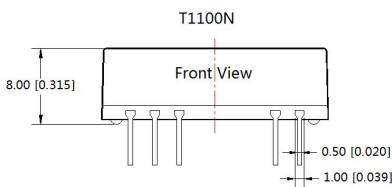

Note : Grid 2.54*2.54mm

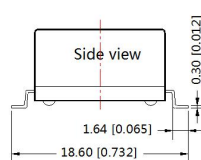
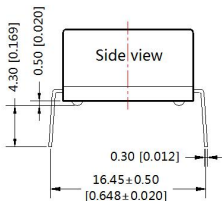

Note:
Unit :mm[inch]
Pin diameter tolerances :±0.10[±0.004]
General tolerances:±0.50[±0.020]

Pin-Out	
Pin	Function
1(Sout-)	Signal output(-)
2(Sout+)	Signal output(+)
7(Sin+)	Signal input(+)
8(Sin-)	Signal input(-)
Others	NC
NC:Pin to be isolated from circuitry	

Notes:

1. For additional information on Product Packaging please refer to www.mornsun-power.com. The Packaging bag number: 58210019;
2. Unless otherwise specified, parameters in this datasheet were measured under the conditions of $T_a=25^{\circ}\text{C}$, humidity<75%RH with nominal input voltage and rated output load;
3. All index testing methods in this datasheet are based on company corporate standards;
4. The above are the performance indicators of the product models listed in this datasheet. Some indicators of non-standard models will exceed the above requirements. For details, please contact our technical staff;
5. We can provide product customization service, please contact our technicians directly for specific information;
6. Products are related to laws and regulations: see "Features" and "EMC";
7. Our products shall be classified according to ISO14001 and related environmental laws and regulations, and shall be handled by qualified units.

MORNSUN Guangzhou Science & Technology Co., Ltd.

Address: No. 5, Kehui St. 1, Kehui Development Center, Science Ave., Guangzhou Science City, Huangpu District, Guangzhou, P. R. China
Tel: 86-20-38601850 Fax: 86-20-38601272 E-mail: info@mornsun.cn www.mornsun-power.com