

15W isolated DC-DC converter DIP package
Ultra-wide input and regulated single output

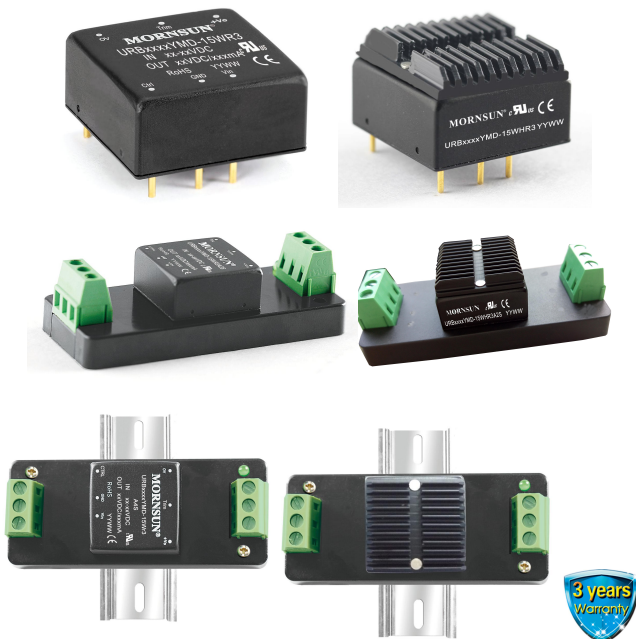

UL **us** **CE** **CB** Patent Protection **RoHS**

FEATURES

- Ultra-wide 4:1 input voltage range
- High efficiency up to 91%
- I/O isolation test voltage 1.5k VDC
- Input under-voltage protection, output short circuit, over-current, over-voltage protection
- Operating ambient temperature range -40°C ~ +105°C
- CISPR32/EN55032 CLASS A EMI compliant without external components
- Input reverse polarity protection available with chassis(A2S) or 35mm DIN-rail mounting(A4S) version
- Industry standard pin-out
- IEC62368, UL62368, EN62368 Approved

URB_YMD-15WR3 series of isolated DC-DC converter products feature an ultra-wide 4:1 input voltage with efficiencies of up to 91%, 1500VDC input to output isolation, an operating ambient temperature range of -40°C to +105°C, input undervoltage protection, output overvoltage, overcurrent, short circuit protection, CISPR32/EN55032 CLASS A EMI compliant without external components, which makes them widely used in industrial control, electric power, instruments and communications applications. Optional packages are offered for chassis or DIN-rail mounting (A2S, A4S), adding additional input reverse polarity protection.

Selection Guide

Certification	Part No. ①	Input Voltage (VDC)		Output		Full Load Efficiency ④ (%) Min./Typ.	Max. Capacitive Load(μF)
		Nominal ② (Range)	Max. ③	Voltage (VDC)	Current(mA) Max./Min.		
UL/CE/CB	URB2403YMD-15WR3	24 (9-36)	40	3.3	4000/0	86/88	4700
	URB2405YMD-15WR3			5	3000/0	88/90	4700
	URB2412YMD-15WR3			12	1250/0	88/90	1000
	URB2415YMD-15WR3			15	1000/0	89/91	820
	URB2424YMD-15WR3			24	625/0	89/91	270
	URB4803YMD-15WR3	48 (18-75)	80	3.3	4000/0	86/88	4700
	URB4805YMD-15WR3			5	3000/0	88/90	4700
	URB4812YMD-15WR3			12	1250/0	89/91	1000
	URB4815YMD-15WR3			15	1000/0	89/91	820
	URB4824YMD-15WR3			24	625/0	89/91	270

Notes:

- ① Use "H" suffix for heat sink mounting, "A2S" suffix for chassis mounting and "A4S" suffix for DIN-Rail mounting. We recommend to choose modules with a heat sink for enhanced heat dissipation and applications with extreme temperature requirements;
- ② The A2S and A4S Model's start-up and minimum input voltages are increased by 1VDC due to the input reverse polarity protection circuit;
- ③ Exceeding the maximum input voltage may cause permanent damage;
- ④ Efficiency is measured at nominal input voltage and rated output load; efficiencies for A2S and A4S model is decreased by 2% due to the input reverse polarity protection circuit.

Input Specifications

Item	Operating Conditions	Min.	Typ.	Max.	Unit
Input Current (full load / no-load)	24VDC nominal input series, nominal input voltage	3.3V output	--	625/30	640/50
		5V output	--	694/30	710/50

Input Current (full load / no-load)	24VDC nominal input series, nominal input voltage	12V output	--	694/6	710/15	mA
		15V output	--	687/6	703/15	
		24V output	--	687/10	703/20	
	48VDC nominal input series, nominal input voltage	3.3V output	--	313/15	320/30	mA
		5V output	--	348/15	356/30	
		12V output	--	344/3	352/11	
		15V output	--	344/3	352/11	
	24V output	--	344/4	352/11		
Reflected Ripple Current	Nominal input voltage	--	30	--		
Surge Voltage (1sec. max.)	24VDC nominal input series	-0.7	--	50	VDC	
	48VDC nominal input series	-0.7	--	100		
Start-up Voltage	24VDC nominal input series	--	--	9		
	48VDC nominal input series	--	--	18		
Input under-voltage protection	24VDC nominal input series	5.5	6.5	--		
	48VDC nominal input series	12	15.5	--		
Start-up Time	Nominal input voltage & constant resistance load	--	10	--	ms	
Input Filter		PI filter				
Hot Plug		Unavailable				
Ctrl*	Module on	Ctrl pin open or pulled high (TTL 3.5-12VDC)				
	Module off	Ctrl pin pulled low to GND (0-1.2VDC)				
	Input current when off	--	2	7	mA	

Note: *The Ctrl pin voltage is referenced to input GND.

Output Specifications

Item	Operating Conditions	Min.	Typ.	Max.	Unit	
Voltage Accuracy	0%-100% load	--	±1	±3	%	
Linear Regulation	Input voltage variation from low to high at full load	--	±0.2	±0.5		
Load Regulation	5%-100% load	--	±0.5	±1		
Transient Recovery Time		--	300	500	μs	
Transient Response Deviation	25% load step change, nominal input voltage	3.3, 5V output	--	±3	±7	%
		Others	--	±3	±5	
Temperature Coefficient	Full load	--	--	±0.03	%/°C	
Ripple & Noise*	20MHz bandwidth, 100% load	--	50	100	mV p-p	
Trim	Input voltage range	90	--	110	%Vo	
Over-voltage Protection		110	--	160		
Over-current Protection		110	150	190	%Io	
Short circuit Protection		Continuous, self-recovery				

Note: *Ripple & Noise at < 5% load is 5%Vo max. The "parallel cable" method is used for Ripple and Noise test, please refer to DC-DC Converter Application Notes for specific information.

General Specifications

Item	Operating Conditions	Min.	Typ.	Max.	Unit	
Isolation	Input-output Electric Strength Test for 1 minute with a leakage current of 1mA max.	1500	--	--	VDC	
	Input/output-case Electric Strength Test for 1 minute with a leakage current of 1mA max.	1000	--	--		
Insulation Resistance	Input-output resistance at 500VDC	1000	--	--	MΩ	
Isolation Capacitance	Input-output capacitance at 100KHz/0.1V	--	2000	--	pF	
Operating Temperature	See Fig. 1	3.3, 5V output	-40	--	+95	°C
		Others	-40	--	+105	

Storage Temperature		-55	--	+125	°C	
Storage Humidity	Non-condensing	5	--	95	%RH	
Pin Soldering Resistance Temperature	Soldering spot is 1.5mm away from case for 10 seconds	--	--	+300	°C	
Vibration		10-150Hz, 5G, 0.75mm. along X, Y and Z				
Switching Frequency *	PWM mode	3.3V, 5V output	--	300	--	KHz
		Others	--	270	--	
MTBF	MIL-HDBK-217F@25°C	1000	--	--	K hours	

Note: *Switching frequency is measured at full load. The module reduces the switching frequency for light load (below 50%) efficiency improvement.

Mechanical Specifications

Case Material	Aluminum alloy				
Dimensions	Horizontal package(without heat sink)	25.40 × 25.40 × 11.70 mm			
	Horizontal package(with heat sink)	25.40 × 25.40 × 16.20 mm			
	A2S chassis package (without heat sink)	76.00 × 31.50 × 21.20 mm			
	A2S chassis package(with heat sink)	76.00 × 31.50 × 25.20 mm			
	A4S Din-rail package(without heat sink)	76.00 × 31.50 × 25.80 mm			
	A4S Din-rail package(with heat sink)	76.00 × 31.50 × 29.80 mm			
Weight	without heat sink	Horizontal package/A2S chassis package/A4S rail package	15.0g/38.0g/58.0g (Typ.)		
	with heat sink	Horizontal package/A2S chassis package/A4S rail package	19.0g/42.0g/62.0g (Typ.)		
Cooling method	Free air convection				

Electromagnetic Compatibility (EMC)

Emissions	CE	CISPR32/EN55032	CLASS A (without external components)/ CLASS B (see Fig.3-② for recommended circuit)	
	RE	CISPR32/EN55032	CLASS A (without external components)/ CLASS B (see Fig.3-② for recommended circuit)	
Immunity	ESD	IEC/EN61000-4-2	Contact ±6KV, Air ±8KV	perf. Criteria B
	RS	IEC/EN61000-4-3	10V/m	perf. Criteria A
	EFT	IEC/EN61000-4-4	±2KV (see Fig.3-① for recommended circuit)	perf. Criteria A
	Surge	IEC/EN61000-4-5	line to line ±2KV (see Fig.3-① for recommended circuit)	perf. Criteria B
	CS	IEC/EN61000-4-6	3 V.r.m.s	perf. Criteria A

Typical Characteristic Curves

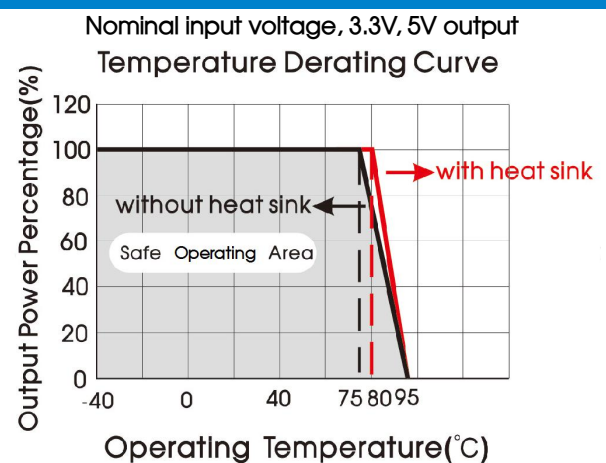
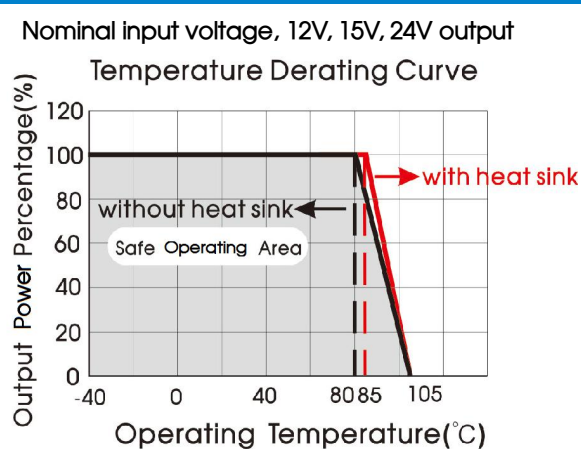
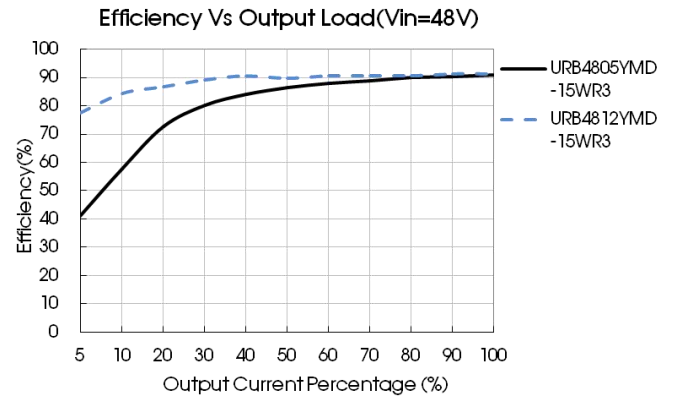
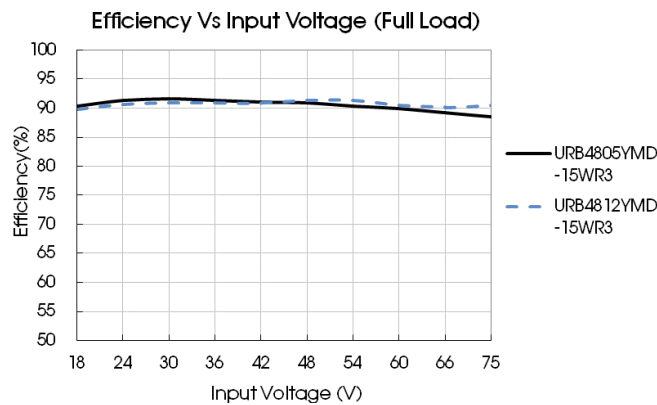
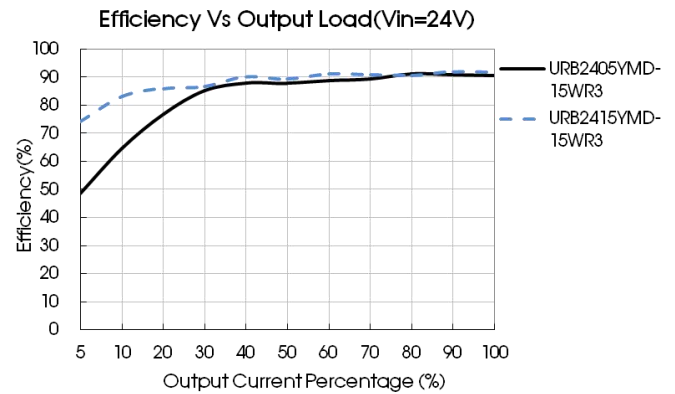
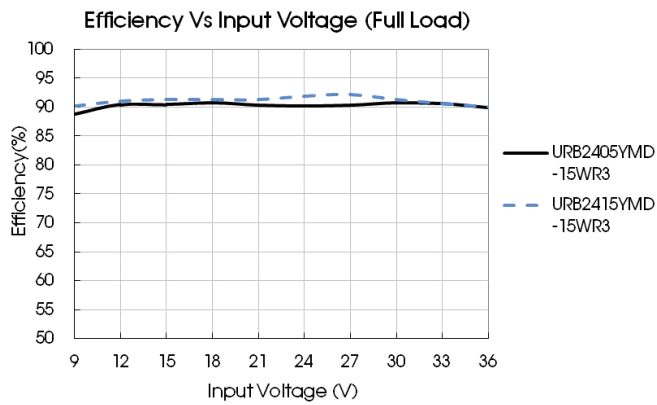

Fig. 1



Design Reference

1. Typical application

All DC-DC converters of this series are tested before delivery using the recommended circuit shown in Fig. 2. Input and/or output ripple can be further reduced by appropriately increasing the input & output capacitor values C_{in} and C_{out} and/or by selecting capacitors with a low ESR (equivalent series resistance). Also make sure that the capacitance is not exceeding the specified max. capacitive load value of the product.

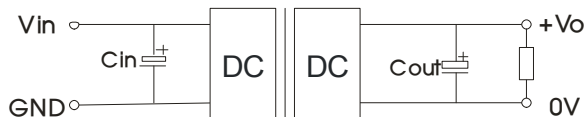

Fig. 2

Vout (VDC)	Cin (μF)	Cout (μF)
3.3/5/12/15	100	100
24		47

2. EMC compliance circuit

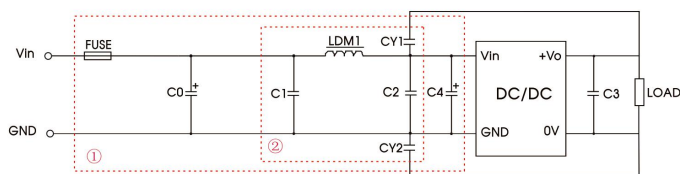

Fig. 3

Notes: We use Part ① in Fig. 3 for Immunity tests and Part ② for Emissions test. Selecting based on needs.

Parameter description:

Model	Vin:24V	Vin:48V
FUSE	Select fuse value according to actual input current	
C0, C4	330μF/50V	330μF/100V
C1, C2	4.7μF/50V	4.7μF/100V
C3	Refer to the Cout in Fig.2	
LDM1	2.2μH/4A	2.2μH/2A
CY1, CY2	1nF/2KV	

3. Trim Function for Output Voltage Adjustment (open if unused)

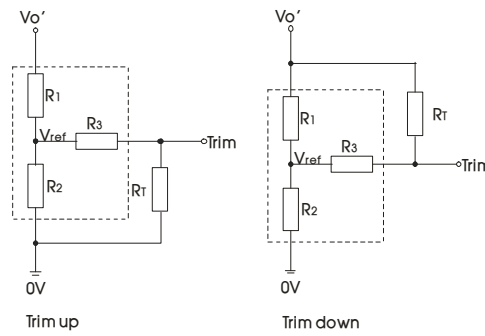

TRIM resistor connection (dashed line shows internal resistor network)

Calculating Trim resistor values:

$$\begin{aligned} \text{up: } R_T &= \frac{\alpha R_2}{R_2 - \alpha} - R_3 & \alpha &= \frac{V_{ref}}{V_{o'} - V_{ref}} \cdot R_1 \\ \text{down: } R_T &= \frac{\alpha R_1}{R_1 - \alpha} - R_3 & \alpha &= \frac{V_{o'} - V_{ref}}{V_{ref}} \cdot R_2 \end{aligned}$$

R_T is Trim resistance
 α is a self-defined parameter, with no real meaning.

Vout(V)	R1(K Ω)	R2(K Ω)	R3(K Ω)	Vref(V)
3.3	4.801	2.87	15	1.24
5	2.894	2.87	10	2.5
12	11.000	2.87	17.4	2.5
15	14.494	2.87	17.4	2.5
24	24.872	2.87	20	2.5

4. The products do not support parallel connection of their output

5. For additional information please refer to DC-DC converter application notes on www.mornsun-power.com

Horizontal Package (without heat sink) Dimensions and Recommended Layout

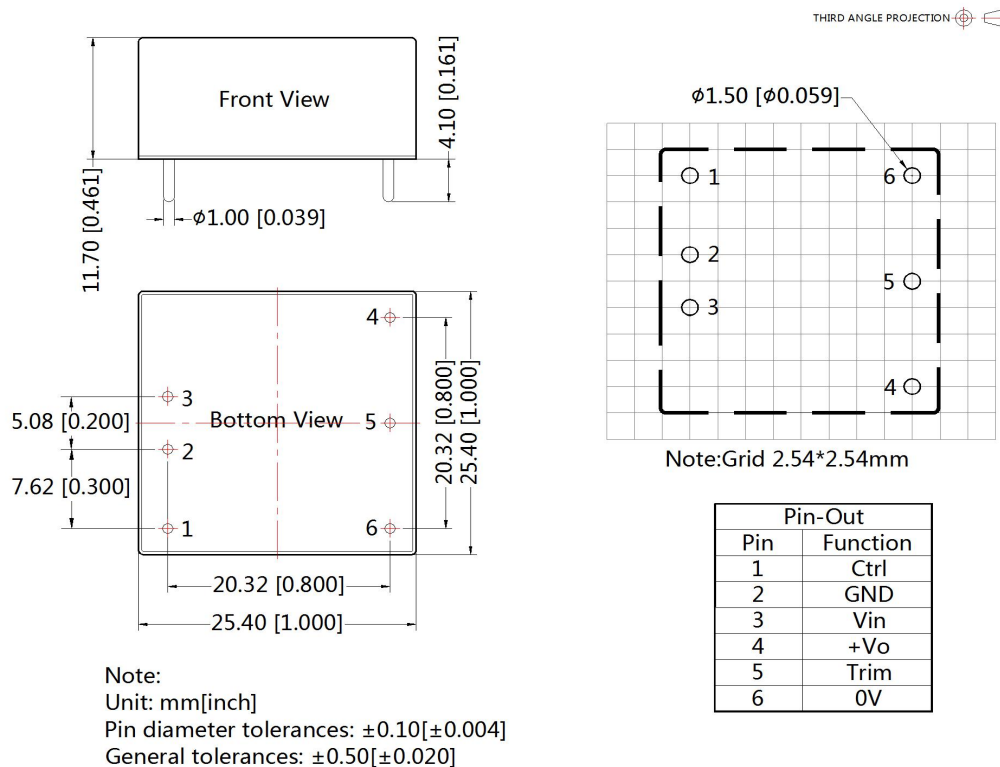

Horizontal Package (with heat sink) Dimensions

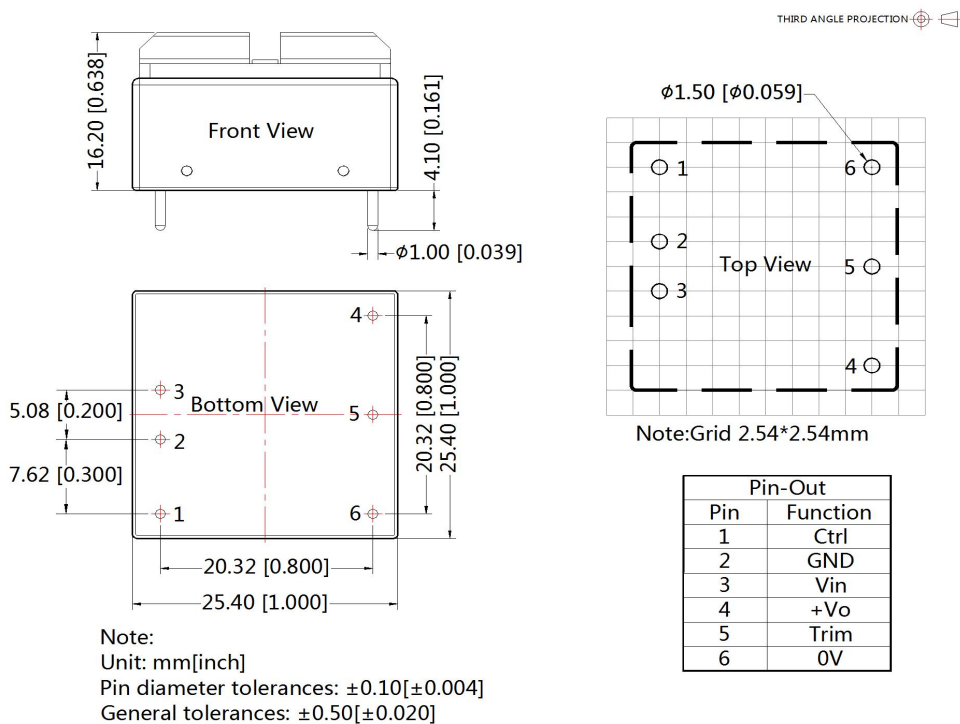

URB_YMD-15WR3A2S Dimensions

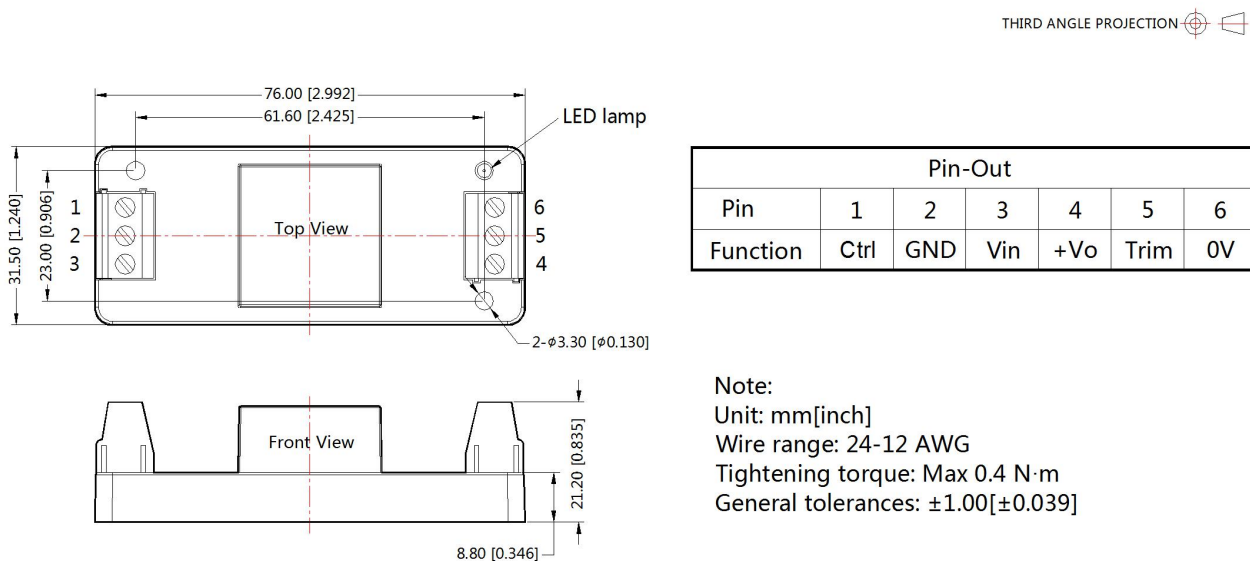

URB_YMD-15WHR3A2S (with heat sink) Dimensions

THIRD ANGLE PROJECTION 

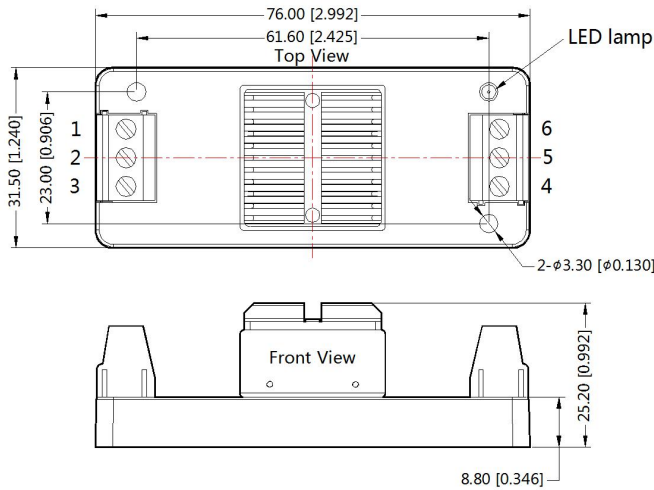

Pin-Out						
Pin	1	2	3	4	5	6
Function	Ctrl	GND	Vin	+Vo	Trim	0V

Note:
Unit: mm[inch]
Wire range: 24-12 AWG
Tightening torque: Max 0.4 N·m
General tolerances: $\pm 1.00[\pm 0.039]$

URB_YMD-15WR3A4S Dimensions

THIRD ANGLE PROJECTION 

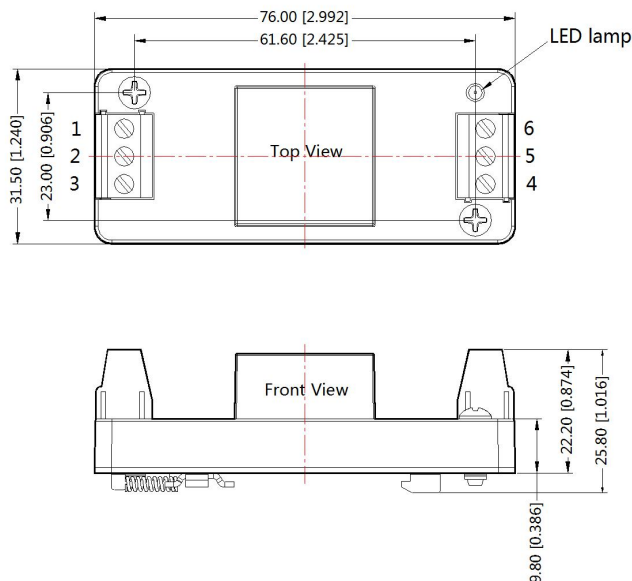

Pin-Out						
Pin	1	2	3	4	5	6
Function	Ctrl	GND	Vin	+Vo	Trim	0V

Note:
Unit: mm[inch]
Wire range: 24-12 AWG
Tightening torque: Max 0.4 N·m
Mounting rail: TS35
General tolerances: $\pm 1.00[\pm 0.039]$

URB_YMD-15WHR3A4S(with heat sink) Dimensions

THIRD ANGLE PROJECTION 

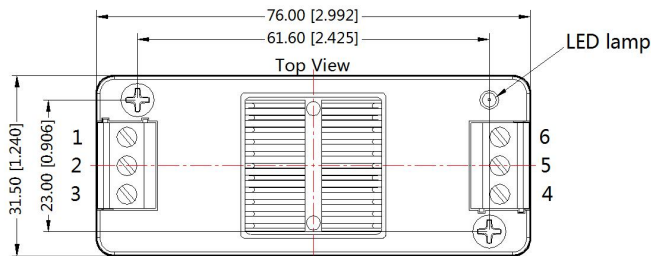

Pin-Out						
Pin	1	2	3	4	5	6
Function	Ctrl	GND	Vin	+Vo	Trim	0V

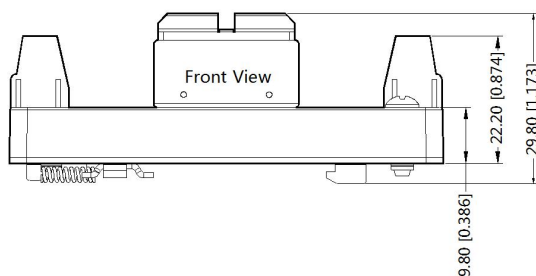

Note:
Unit: mm[inch]
Wire range: 24-12 AWG
Tightening torque: Max 0.4 N·m
General tolerances: $\pm 1.00[\pm 0.039]$

- Note:
1. For additional information on Product Packaging please refer to www.mornsun-power.com. Packaging bag number: 58210003 (DIP), 58200048 (with heat sink), 58220022(A2S/A4S package);
 2. The maximum capacitive load offered were tested at input voltage range and full load;
 3. Unless otherwise specified, parameters in this datasheet were measured under the conditions of $T_a=25^{\circ}\text{C}$, humidity<75%RH with nominal input voltage and rated output load;
 4. All index testing methods in this datasheet are based on company corporate standards;
 5. We can provide product customization service, please contact our technicians directly for specific information;
 6. Products are related to laws and regulations: see "Features" and "EMC";
 7. Our products shall be classified according to ISO14001 and related environmental laws and regulations, and shall be handled by qualified units.

Mornsun Guangzhou Science & Technology Co., Ltd.

Address: No. 5, Kehui St. 1, Kehui Development Center, Science Ave., Guangzhou Science City, Huangpu District, Guangzhou, P. R. China
Tel: 86-20-38601850 Fax: 86-20-38601272 E-mail: info@mornsun.cn www.mornsun-power.com