

National Semiconductor is now part of  
Texas Instruments.

Search <http://www.ti.com/> for the latest technical  
information and details on our current products and services.

# DS9638

## RS-422 Dual High Speed Differential Line Driver

### General Description

The DS9638 is a Schottky, TTL compatible, dual differential line driver designed specifically to meet the EIA Standard RS-422 specifications. It is designed to provide unipolar differential drive to twisted pair or parallel wire transmission lines. The inputs are TTL compatible. The outputs are similar to totem pole TTL outputs, with active pull-up and pull-down. The device features a short circuit protected active pull-up with low output impedance and is specified to drive 50Ω transmission lines at high speed. The mini-DIP provides high package density.

### Features

- Single 5V supply
- Schottky technology
- TTL and CMOS compatible inputs
- Output short circuit protection
- Input clamp diodes
- Complementary outputs
- Minimum output skew (<1.0 ns typical)
- 50 mA output drive capability for 50Ω transmission lines
- Meets EIA RS-422 specifications
- Propagation delay of less than 10 ns
- "Glitchless" differential output
- Delay time stable with  $V_{CC}$  and temperature variations (<2.0 ns typical) (Figure 3)
- Extended temperature range

**3**

### Connection Diagram

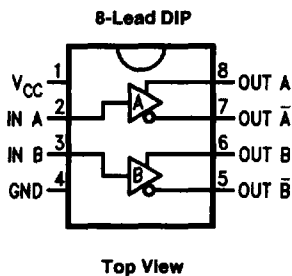

TL/F/9622-1

Order Number DS9638CJ, DS9638MJ,  
DS9638CM or DS9638CN  
See NS Package Number J08A, M08A or N08E

For Complete Military 883 Specifications,  
see RETS Datasheet.  
Order Number DS9638MJ/883  
See NS Package Number J08A

**Absolute Maximum Ratings** (Note 1)

If Military/Aerospace specified devices are required, please contact the National Semiconductor Sales Office/Distributors for availability and specifications.

## Storage Temperature Range

Ceramic DIP	-65°C to +175°C
Molded DIP and SO-8	-65°C to +150°C

## Lead Temperature

Ceramic DIP (Soldering, 60 sec.)	300°C
Molded DIP (Soldering, 10 sec.)	265°C

## Maximum Power Dissipation\* at 25°C

Cavity Package	1300 mW
Molded Package	930 mW
SO Package	810 mW

V<sub>CC</sub> Lead Potential to Ground

-5V to 7V

## Input Voltage

-0.5V to +7V

\*Derate cavity package 8.7 mW/°C above 25°C; derate molded DIP package 7.5 mW/°C above 25°C; derate SO package 6.5 mW/°C above 25°C.

**Recommended Operating Conditions**

	DS9638M			DS9638C			Units
	Min	Typ	Max	Min	Typ	Max	
Supply Voltage (V <sub>CC</sub> )	4.5	5.0	5.5	4.75	5.0	5.25	V
Output Current HIGH (I <sub>OH</sub> )			-50			-50	mA
Output Current LOW (I <sub>OL</sub> )			50	40		50	mA
Operating Temperature (T <sub>A</sub> )	-55	25	125	0	25	70	°C

**Electrical Characteristics** Over recommended operating temperature and supply voltage ranges, unless otherwise specified (Notes 2 & 3)

Symbol	Parameter	Conditions	Min	Typ	Max	Units
V <sub>IH</sub>	Input Voltage HIGH		2.0			V
V <sub>IL</sub>	Input Voltage LOW	0°C to +70°C			0.8	V
		-55°C to +125°C			0.5	
V <sub>IC</sub>	Input Clamp Voltage	V <sub>CC</sub> = Min, I <sub>I</sub> = -18 mA		-1.0	-1.2	V
V <sub>OH</sub>	Output Voltage HIGH	V <sub>CC</sub> = Min, V <sub>IH</sub> = V <sub>IH</sub> Min, V <sub>IL</sub> = V <sub>IL</sub> Max	I <sub>OH</sub> = -10 mA	2.5	3.5	V
			I <sub>OH</sub> = -40 mA	2.0		
V <sub>OL</sub>	Output Voltage LOW	V <sub>CC</sub> = Min, V <sub>IH</sub> = V <sub>IH</sub> Min, V <sub>IL</sub> = V <sub>IL</sub> Max, I <sub>OL</sub> = 40 mA			0.5	V
I <sub>I</sub>	Input Current at Maximum Input Voltage	V <sub>CC</sub> = Max, V <sub>I</sub> Max = 5.5V			50	μA
I <sub>IH</sub>	Input Current HIGH	V <sub>CC</sub> = Max, V <sub>IH</sub> = 2.7V			25	μA
I <sub>IL</sub>	Input Current LOW	V <sub>CC</sub> = Max, V <sub>IL</sub> = 0.5V			-200	μA
I <sub>OS</sub>	Output Short Circuit Current	V <sub>CC</sub> = Max, V <sub>O</sub> = 0V (Note 4)	-50		-150	mA
V <sub>T</sub> , $\bar{V}_T$	Terminated Output Voltage	See Figure 1	2.0			V
V <sub>T</sub> - $\bar{V}_T$	Output Balance				0.4	V
V <sub>OS</sub> , $\bar{V}_{OS}$	Output Offset Voltage				3.0	V
V <sub>OS</sub> - $\bar{V}_{OS}$	Output Offset Balance				0.4	V
I <sub>X</sub>	Output Leakage Current	T <sub>A</sub> = 25°C -0.25V < V <sub>X</sub> < 5.5V			100	μA
I <sub>CC</sub>	Supply Current (Both Drivers)	V <sub>CC</sub> = 5.5V, All input at 0V, No Load		45	65	mA

**Note 1:** "Absolute Maximum Ratings" are those values beyond which the safety of the device cannot be guaranteed. They are not meant to imply that the devices should be operated at these limits. The tables of "Electrical Characteristics provide conditions for actual device operation.

**Note 2:** Unless otherwise specified min/max limits apply across the -55°C to +125°C temperature range for the DS9638M and across the 0°C to +70°C range for the DS9638C. All typicals are given for V<sub>CC</sub> = 5V and T<sub>A</sub> = 25°C.

**Note 3:** All currents into the device pins are positive; all currents out of the device pins are negative. All voltages are referenced to ground unless otherwise specified.

**Note 4:** Only one output at a time should be shorted.

### Switching Characteristics $V_{CC} = 5.0V, T_A = 25^\circ C.$

Symbol	Parameter	Conditions	Min	Typ	Max	Units
$t_{PHL}$	Propagation Delay	$C_L = 15\text{ pF}$ $R_L = 100\Omega$ , See Figure 2		10	20	ns
$t_{PLH}$				10	20	ns
$t_f$	Fall Time, 90%–10%			10	20	ns
$t_r$	Rise Time, 10%–90%			10	20	ns
$t_{PO-t_{P\bar{O}}}$	Skew Between Outputs A/ $\bar{A}$ and B/ $\bar{B}$			1.0		ns

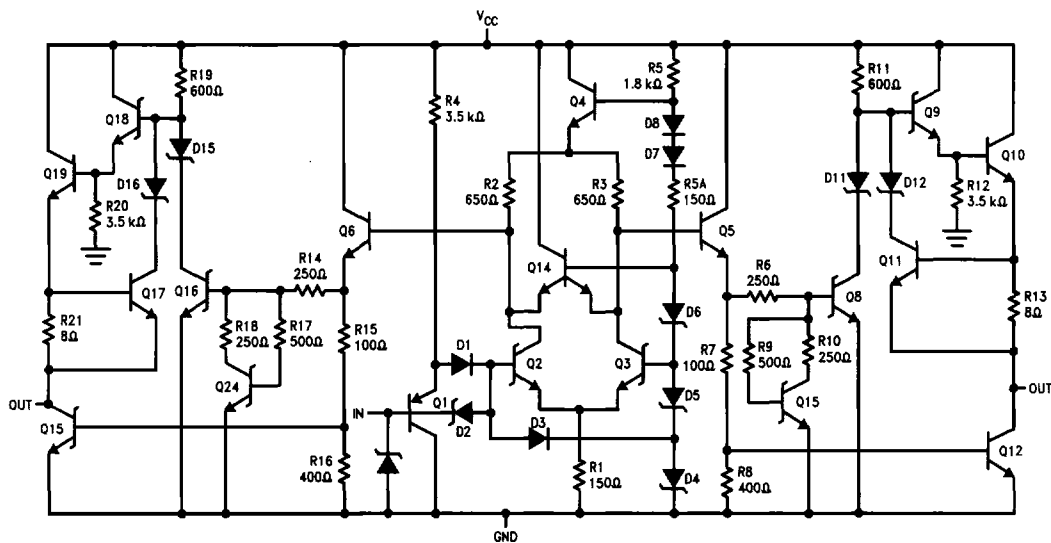
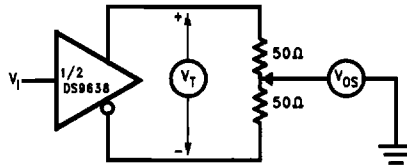

FIGURE 1. Equivalent Circuit

TL/F/9622-2

## DC Test Circuit



TL/F/9622-3

FIGURE 2. Terminated Output Voltage and Output Balance

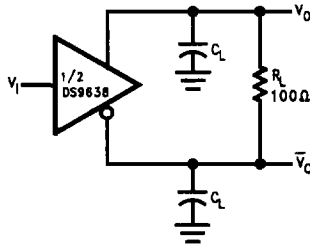

TL/F/9622-4

Note:

The pulse generator has the following characteristics:

PRR = 500 kHz,  $t_w = 100$  ns,

$t_r \leq 5.0$  ns,  $Z_0 = 50\Omega$ .

$C_L$  includes probe and jig capacitance.

FIGURE 3. AC Test Circuit and Voltage Waveform

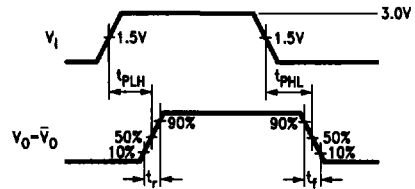
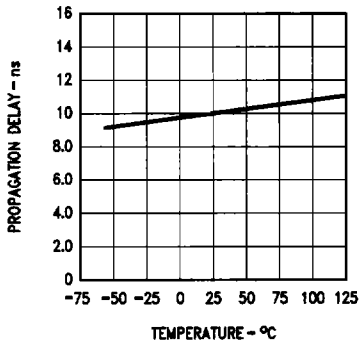

FIGURE 3a

TL/F/9622-5



TL/F/9622-6

FIGURE 4. Typical Delay Characteristics

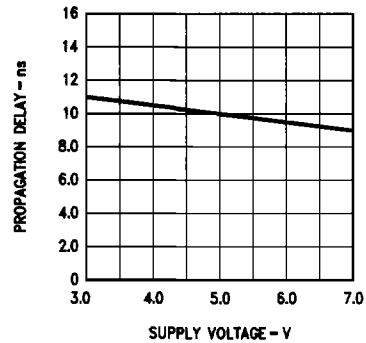

FIGURE 4a

TL/F/9622-7