

National Semiconductor is now part of  
Texas Instruments.

Search <http://www.ti.com/> for the latest technical  
information and details on our current products and services.

## LM741 Operational Amplifier

### General Description

The LM741 series are general purpose operational amplifiers which feature improved performance over industry standards like the LM709. They are direct, plug-in replacements for the 709C, LM201, MC1439 and 748 in most applications.

The amplifiers offer many features which make their application nearly foolproof: overload protection on the input and output, no latch-up when the common mode range is exceeded, as well as freedom from oscillations.

The LM741C/LM741E are identical to the LM741/LM741A except that the LM741C/LM741E have their performance guaranteed over a 0°C to +70°C temperature range, instead of -55°C to +125°C.

### Schematic Diagram

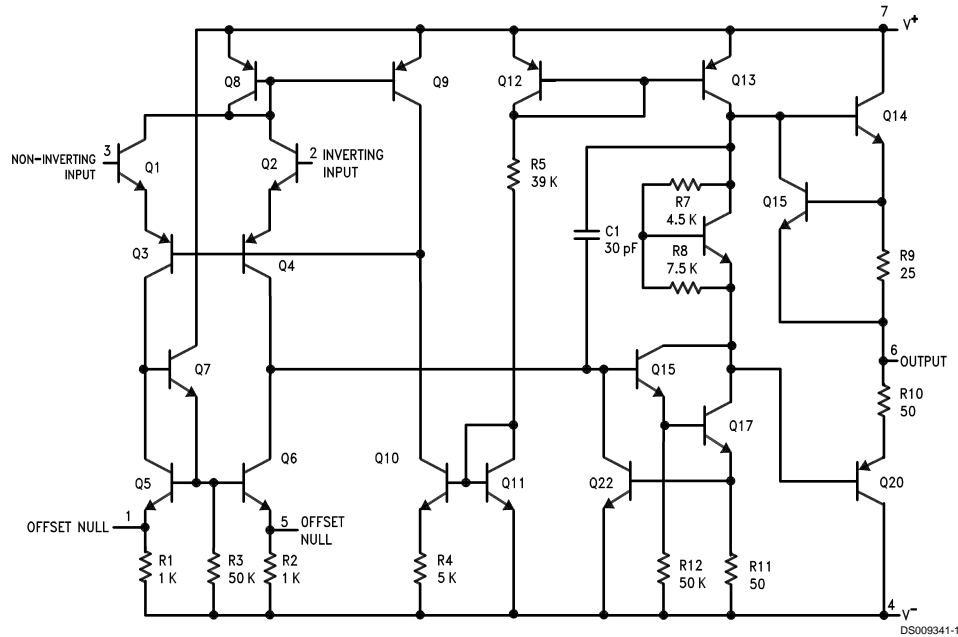

Offset Nulling Circuit

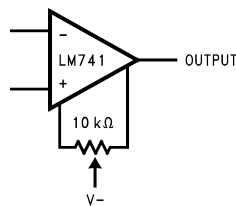

DS009341-7

## Absolute Maximum Ratings (Note 1)

If Military/Aerospace specified devices are required, please contact the National Semiconductor Sales Office/Distributors for availability and specifications.

(Note 6)

	LM741A	LM741E	LM741	LM741C
Supply Voltage	±22V	±22V	±22V	±18V
Power Dissipation (Note 2)	500 mW	500 mW	500 mW	500 mW
Differential Input Voltage	±30V	±30V	±30V	±30V
Input Voltage (Note 3)	±15V	±15V	±15V	±15V
Output Short Circuit Duration	Continuous	Continuous	Continuous	Continuous
Operating Temperature Range	-55°C to +125°C	0°C to +70°C	-55°C to +125°C	0°C to +70°C
Storage Temperature Range	-65°C to +150°C	-65°C to +150°C	-65°C to +150°C	-65°C to +150°C
Junction Temperature	150°C	100°C	150°C	100°C
Soldering Information				
N-Package (10 seconds)	260°C	260°C	260°C	260°C
J- or H-Package (10 seconds)	300°C	300°C	300°C	300°C
M-Package				
Vapor Phase (60 seconds)	215°C	215°C	215°C	215°C
Infrared (15 seconds)	215°C	215°C	215°C	215°C
See AN-450 "Surface Mounting Methods and Their Effect on Product Reliability" for other methods of soldering surface mount devices.				
ESD Tolerance (Note 7)	400V	400V	400V	400V

## Electrical Characteristics (Note 4)

Parameter	Conditions	LM741A/LM741E			LM741			LM741C			Units
		Min	Typ	Max	Min	Typ	Max	Min	Typ	Max	
Input Offset Voltage	$T_A = 25^\circ\text{C}$										
	$R_S \leq 10\text{ k}\Omega$		0.8	3.0		1.0	5.0		2.0	6.0	mV
	$R_S \leq 50\Omega$										mV
Average Input Offset Voltage Drift	$T_{AMIN} \leq T_A \leq T_{AMAX}$			4.0							mV
	$R_S \leq 50\Omega$						6.0			7.5	mV
	$R_S \leq 10\text{ k}\Omega$										$\mu\text{V}/^\circ\text{C}$
Average Input Offset Voltage Drift			15								$\mu\text{V}/^\circ\text{C}$
Input Offset Voltage Adjustment Range	$T_A = 25^\circ\text{C}, V_S = \pm 20\text{V}$	±10				±15			±15		mV
Input Offset Current	$T_A = 25^\circ\text{C}$		3.0	30		20	200		20	200	nA
	$T_{AMIN} \leq T_A \leq T_{AMAX}$			70		85	500			300	nA
Average Input Offset Current Drift				0.5							$\text{nA}/^\circ\text{C}$
Input Bias Current	$T_A = 25^\circ\text{C}$		30	80		80	500		80	500	nA
	$T_{AMIN} \leq T_A \leq T_{AMAX}$			0.210			1.5			0.8	$\mu\text{A}$
Input Resistance	$T_A = 25^\circ\text{C}, V_S = \pm 20\text{V}$	1.0	6.0		0.3	2.0		0.3	2.0		$\text{M}\Omega$
	$T_{AMIN} \leq T_A \leq T_{AMAX}, V_S = \pm 20\text{V}$	0.5									$\text{M}\Omega$
Input Voltage Range	$T_A = 25^\circ\text{C}$							±12	±13		V
	$T_{AMIN} \leq T_A \leq T_{AMAX}$				±12	±13					V

## Electrical Characteristics (Note 4) (Continued)

Parameter	Conditions	LM741A/LM741E			LM741			LM741C			Units
		Min	Typ	Max	Min	Typ	Max	Min	Typ	Max	
Large Signal Voltage Gain	$T_A = 25^\circ\text{C}$ , $R_L \geq 2\text{ k}\Omega$ $V_S = \pm 20\text{V}$ , $V_O = \pm 15\text{V}$ $V_S = \pm 15\text{V}$ , $V_O = \pm 10\text{V}$	50			50	200		20	200		V/mV V/mV
	$T_{AMIN} \leq T_A \leq T_{AMAX}$ , $R_L \geq 2\text{ k}\Omega$ , $V_S = \pm 20\text{V}$ , $V_O = \pm 15\text{V}$ $V_S = \pm 15\text{V}$ , $V_O = \pm 10\text{V}$	32			25			15			V/mV V/mV
	$V_S = \pm 5\text{V}$ , $V_O = \pm 2\text{V}$	10									V/mV
Output Voltage Swing	$V_S = \pm 20\text{V}$ $R_L \geq 10\text{ k}\Omega$ $R_L \geq 2\text{ k}\Omega$	$\pm 16$ $\pm 15$									V V
	$V_S = \pm 15\text{V}$ $R_L \geq 10\text{ k}\Omega$ $R_L \geq 2\text{ k}\Omega$				$\pm 12$ $\pm 10$	$\pm 14$ $\pm 13$		$\pm 12$ $\pm 10$	$\pm 14$ $\pm 13$		V V
Output Short Circuit Current	$T_A = 25^\circ\text{C}$	10	25	35		25			25		mA
	$T_{AMIN} \leq T_A \leq T_{AMAX}$	10		40							mA
Common-Mode Rejection Ratio	$T_{AMIN} \leq T_A \leq T_{AMAX}$ $R_S \leq 10\text{ k}\Omega$ , $V_{CM} = \pm 12\text{V}$ $R_S \leq 50\Omega$ , $V_{CM} = \pm 12\text{V}$	80	95		70	90		70	90		dB dB
	$T_{AMIN} \leq T_A \leq T_{AMAX}$ , $V_S = \pm 20\text{V}$ to $V_S = \pm 5\text{V}$ $R_S \leq 50\Omega$ $R_S \leq 10\text{ k}\Omega$	86	96		77	96		77	96		dB dB
Transient Response	$T_A = 25^\circ\text{C}$ , Unity Gain	Rise Time		0.25	0.8		0.3		0.3		$\mu\text{s}$
		Overshoot		6.0	20		5		5		%
Bandwidth (Note 5)	$T_A = 25^\circ\text{C}$	0.437	1.5								MHz
Slew Rate	$T_A = 25^\circ\text{C}$ , Unity Gain	0.3	0.7			0.5			0.5		V/ $\mu\text{s}$
Supply Current	$T_A = 25^\circ\text{C}$					1.7	2.8		1.7	2.8	mA
Power Consumption	$T_A = 25^\circ\text{C}$ $V_S = \pm 20\text{V}$ $V_S = \pm 15\text{V}$		80	150							mW mW
	LM741A $V_S = \pm 20\text{V}$ $T_A = T_{AMIN}$ $T_A = T_{AMAX}$			165 135							mW mW
LM741E	$V_S = \pm 20\text{V}$ $T_A = T_{AMIN}$ $T_A = T_{AMAX}$			150 150							mW mW
	LM741 $V_S = \pm 15\text{V}$ $T_A = T_{AMIN}$ $T_A = T_{AMAX}$					60 45	100 75				mW mW

**Note 1:** "Absolute Maximum Ratings" indicate limits beyond which damage to the device may occur. Operating Ratings indicate conditions for which the device is functional, but do not guarantee specific performance limits.

## Electrical Characteristics (Note 4) (Continued)

**Note 2:** For operation at elevated temperatures, these devices must be derated based on thermal resistance, and  $T_j$  max. (listed under "Absolute Maximum Ratings").  $T_j = T_A + (\theta_{JA} P_D)$ .

Thermal Resistance	Cerdip (J)	DIP (N)	HO8 (H)	SO-8 (M)
$\theta_{JA}$ (Junction to Ambient)	100°C/W	100°C/W	170°C/W	195°C/W
$\theta_{JC}$ (Junction to Case)	N/A	N/A	25°C/W	N/A

**Note 3:** For supply voltages less than  $\pm 15V$ , the absolute maximum input voltage is equal to the supply voltage.

**Note 4:** Unless otherwise specified, these specifications apply for  $V_S = \pm 15V$ ,  $-55^\circ C \leq T_A \leq +125^\circ C$  (LM741/LM741A). For the LM741C/LM741E, these specifications are limited to  $0^\circ C \leq T_A \leq +70^\circ C$ .

**Note 5:** Calculated value from:  $BW$  (MHz) =  $0.35/\text{Rise Time}(\mu s)$ .

**Note 6:** For military specifications see RETS741X for LM741 and RETS741AX for LM741A.

**Note 7:** Human body model, 1.5 k $\Omega$  in series with 100 pF.

## Connection Diagram

**Metal Can Package**

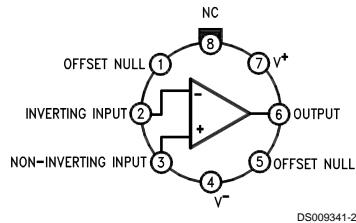

DS009341-2

**Note 8:** LM741H is available per JM38510/10101

**Order Number LM741H, LM741H/883 (Note 8),  
LM741AH/883 or LM741CH  
See NS Package Number H08C**

**Ceramic Dual-In-Line Package**

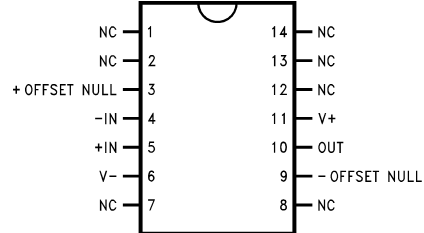

DS009341-5

**Note 9:** also available per JM38510/10101

**Note 10:** also available per JM38510/10102

**Order Number LM741J-14/883 (Note 9),  
LM741AJ-14/883 (Note 10)  
See NS Package Number J14A**

**Dual-In-Line or S.O. Package**

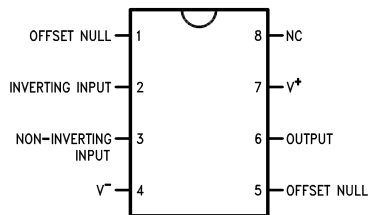

DS009341-3

**Order Number LM741J, LM741J/883,  
LM741CM, LM741CN or LM741EN  
See NS Package Number J08A, M08A or N08E**

**Ceramic Flatpak**

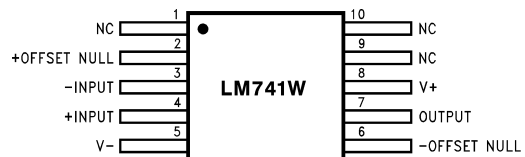

DS009341-6

**Order Number LM741W/883  
See NS Package Number W10A**

**Physical Dimensions** inches (millimeters) unless otherwise noted

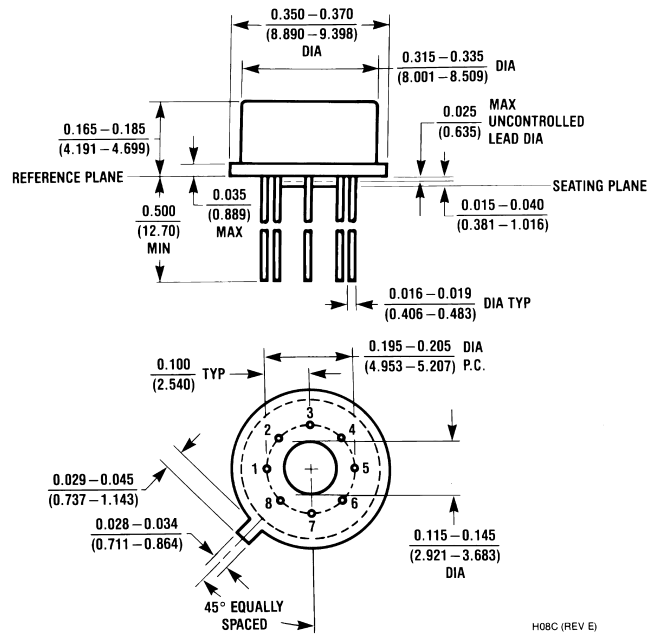

**Metal Can Package (H)**  
 Order Number LM741H, LM741H/883, LM741AH/883, LM741CH or LM741EH  
 NS Package Number H08C

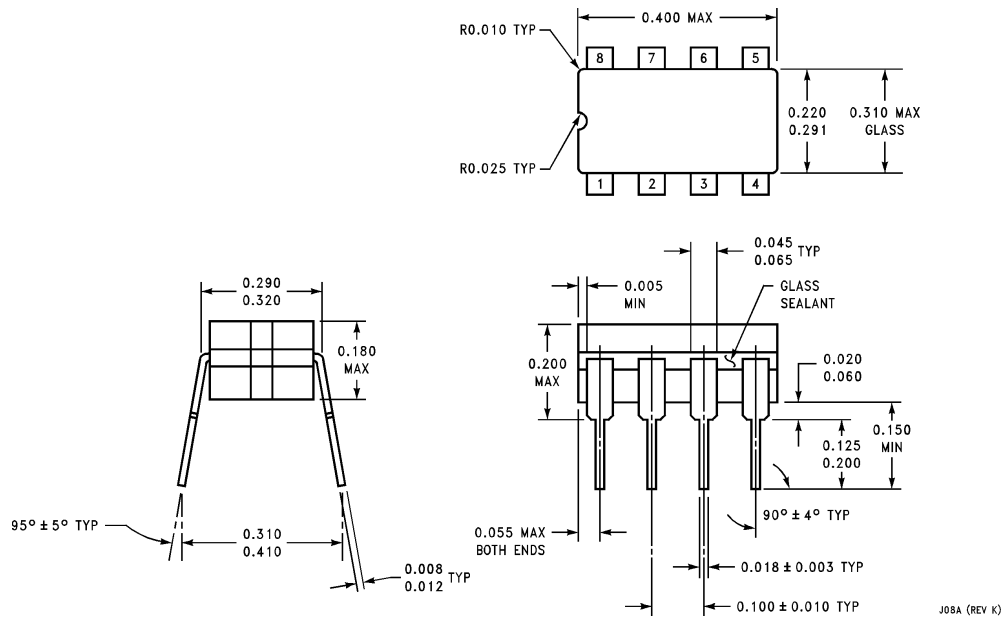

**Ceramic Dual-In-Line Package (J)**  
 Order Number LM741CJ or LM741J/883  
 NS Package Number J08A

**Physical Dimensions** inches (millimeters) unless otherwise noted (Continued)

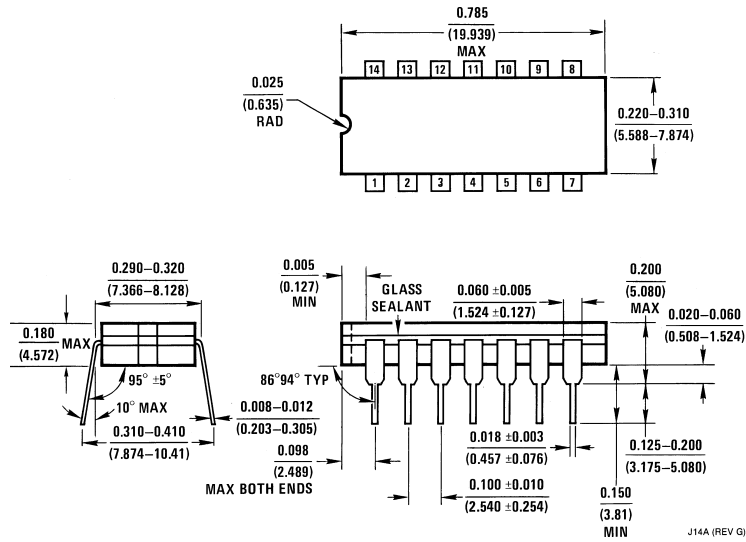

**Ceramic Dual-In-Line Package (J)**  
**Order Number LM741J-14/883 or LM741AJ-14/883**  
**NS Package Number J14A**

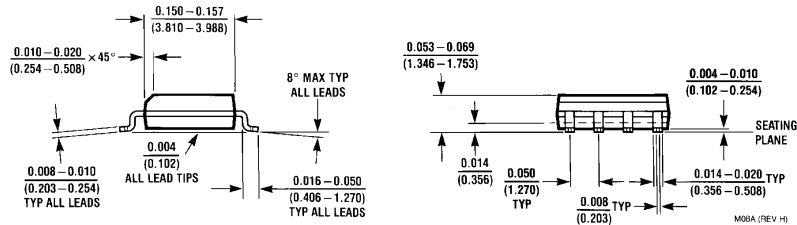
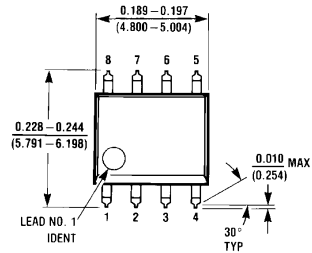

**Small Outline Package (M)**  
**Order Number LM741CM**  
**NS Package Number M08A**

**Physical Dimensions** inches (millimeters) unless otherwise noted (Continued)

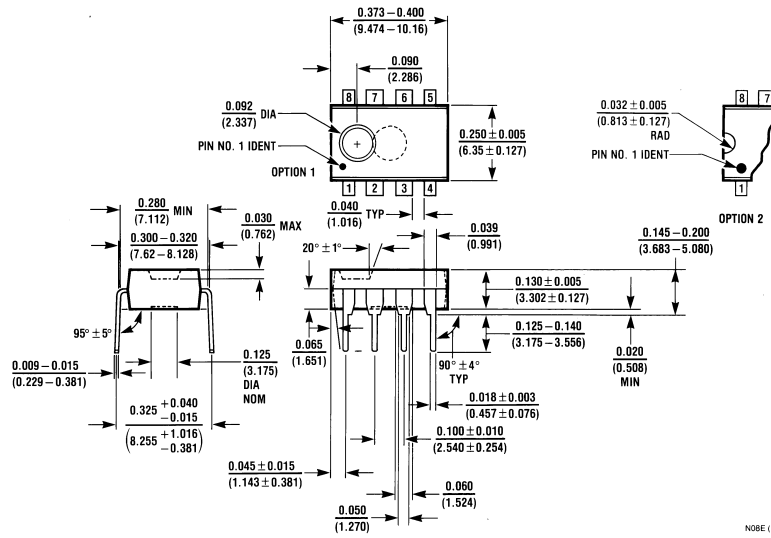

**Dual-In-Line Package (N)**  
**Order Number LM741CN or LM741EN**  
**NS Package Number N08E**

N08E (REV F)



**Physical Dimensions** inches (millimeters) unless otherwise noted (Continued)

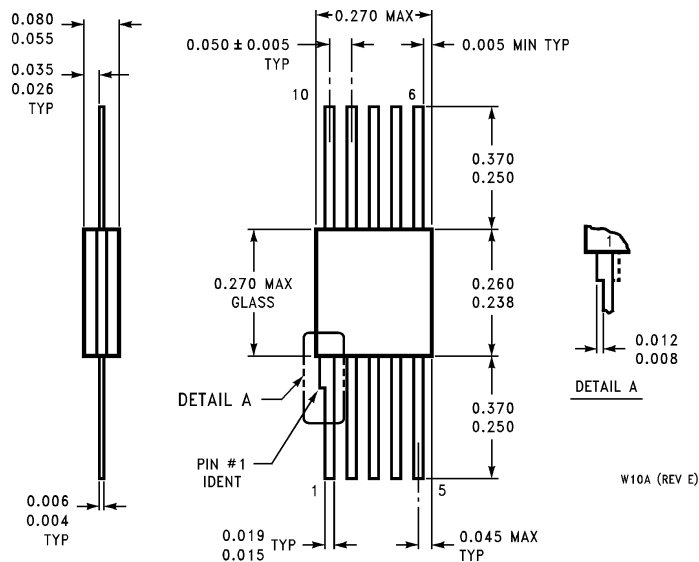

**10-Lead Ceramic Flatpak (W)**  
**Order Number LM741W/883**  
**NS Package Number W10A**

**LIFE SUPPORT POLICY**

NATIONAL'S PRODUCTS ARE NOT AUTHORIZED FOR USE AS CRITICAL COMPONENTS IN LIFE SUPPORT DEVICES OR SYSTEMS WITHOUT THE EXPRESS WRITTEN APPROVAL OF THE PRESIDENT OF NATIONAL SEMICONDUCTOR CORPORATION. As used herein:

1. Life support devices or systems are devices or systems which, (a) are intended for surgical implant into the body, or (b) support or sustain life, and whose failure to perform when properly used in accordance with instructions for use provided in the labeling, can be reasonably expected to result in a significant injury to the user.
2. A critical component is any component of a life support device or system whose failure to perform can be reasonably expected to cause the failure of the life support device or system, or to affect its safety or effectiveness.

**National Semiconductor Corporation**  
 Americas  
 Tel: 1-800-272-9959  
 Fax: 1-800-737-7018  
 Email: support@nsc.com

**National Semiconductor Europe**  
 Fax: +49 (0) 1 80-530 85 86  
 Email: europe.support@nsc.com  
 Deutsch Tel: +49 (0) 1 80-530 85 85  
 English Tel: +49 (0) 1 80-532 78 32  
 Français Tel: +49 (0) 1 80-532 93 58  
 Italiano Tel: +49 (0) 1 80-534 16 80

**National Semiconductor Asia Pacific Customer Response Group**  
 Tel: 65-2544466  
 Fax: 65-2504466  
 Email: sea.support@nsc.com

**National Semiconductor Japan Ltd.**  
 Tel: 81-3-5639-7560  
 Fax: 81-3-5639-7507

www.national.com

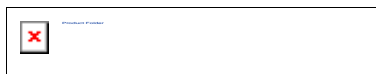
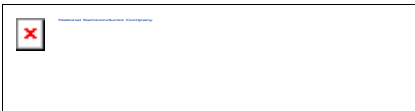

## LM741 Operational Amplifier

See Also: [LM107](#) - less noise & better accuracy

Generic P/N 741

### Contents

- [General Description](#)
- [Datasheet](#)
- [Package Availability, Models, Samples & Pricing](#)
- [Design Tools](#)
- [Application Notes](#)

Parametric Table	
Channels (Channels)	1
Input Output Type	Not Rail to Rail
Bandwidth, typ (MHz)	1
Slew Rate, typ (Volts/usec)	.50
Supply Current per Channel, typ (mA)	1.70
Minimum Supply Voltage (Volt)	10
Maximum Supply Voltage (Volt)	36,44
Offset Voltage, Max (mV)	6,5,3
Input Bias Current, Temp Max (nA)	800,1500,210
Output Current, typ (mA)	25
Voltage Noise, typ (nV/Hz)	30
Shut down	No
Special Features	Vos Adj



## General Description

The LM741 series are general purpose operational amplifiers which feature improved performance over industry standards like the LM709. They are direct, plug-in replacements for the 709C, LM201, MC1439 and 748 in most applications.

The amplifiers offer many features which make their application nearly foolproof: overload protection on the input and output, no latch-up when the common mode range is exceeded, as well as freedom from oscillations.





The LM741C/LM741E are identical to the LM741/LM741A except that the LM741C/LM741E have their performance guaranteed over a 0°C to +70°C temperature range, instead of -55°C to +125°C.





## Datasheet

Title	Size (in Kbytes)	Date	 View Online	 Download	 Receive via Email
LM741 Operational Amplifier	213 Kbytes	24-Jun-99	<a href="#">View Online</a>	<a href="#">Download</a>	<a href="#">Receive via Email</a>
LM741 Mil-Aero Datasheet MNLM741-X	320 Kbytes		<a href="#">View Online</a>	<a href="#">Download</a>	<a href="#">Receive via Email</a>
LM741 Mil-Aero Datasheet MNLM741A-X	20 Kbytes		<a href="#">View Online</a>	<a href="#">Download</a>	<a href="#">Receive via Email</a>

Please use [Adobe Acrobat](#) to view PDF file(s).  
If you have trouble printing, see [Printing Problems](#).



## Package Availability, Models, Samples & Pricing

Part Number	Package		Status	Models		Samples & Electronic Orders	Budgetary Pricing	
	Type	# pins		SPICE	IBIS		Quantity	\$US ea
LM741CN	<a href="#">MDIP</a>	8	Full production	<a href="#">LM741.MOD</a>	N/A		2500+	\$0.232
LM741CH	TO-5	8	Full production	<a href="#">LM741.MOD</a>	N/A		1K+	\$0.934
LM741H	TO-5	8	Full production	<a href="#">LM741.MOD</a>	N/A		250+	\$1.450
LM741AH-MIL	TO-5	8	Preliminary	<a href="#">LM741.MOD</a>	N/A	.		
LM741AH/883	TO-5	8	Full production	<a href="#">LM741.MOD</a>	N/A		50+	\$5.100

LM741H/883	TO-5	8	Full production	<a href="#">LM741.MOD</a>	N/A		50+	\$2.050
LM741J/883	Cerdip	8	Full production	<a href="#">LM741.MOD</a>	N/A		50+	\$1.450
LM741W/883	Cerpack	10	Full production	<a href="#">LM741.MOD</a>	N/A		50+	\$9.600
LM741WG/883	Ceramic SOIC	10	Full production	<a href="#">LM741.MOD</a>	N/A		50+	\$9.100
LM741WG-MPR	Ceramic SOIC	10	Preliminary	<a href="#">LM741.MOD</a>	N/A	.		
JM38510/10101BG	TO-5	8	Full production	N/A	N/A	.	50+	\$5.100
JM38510/10101BP	Cerdip	8	Full production	N/A	N/A	.	50+	\$5.100
JM38510/10101BC	Cerdip	14	Full production	N/A	N/A	.	50+	\$5.200
JM38510/10101BH	Cerpack	10	Full production	N/A	N/A	.	50+	\$23.000
JM38510/10101SG	TO-5	8	Full production	N/A	N/A	.	50+	\$163.00
JM38510/10101SP	Cerdip	8	Full production	N/A	N/A	.	50+	\$195.00
LM741C MDC	die		Full production	<a href="#">LM741.MOD</a>	N/A	.		







LM741C MWC	wafer	Full production	<a href="#">LM741.MOD</a>	N/A	.		
LM741 MDS	die	Full production	<a href="#">LM741.MOD</a>	N/A	.		
LM741 MW8	wafer	Full production	<a href="#">LM741.MOD</a>	N/A	.		

## Design Tools

Title	Size (in Kbytes)	Date	 View Online	 Download	 Receive via Email
Amplifiers Selection Guide software for Windows	8 Kbytes	26-May-2000		<a href="#">View</a>	

Please use [Adobe Acrobat](#) to view PDF file(s).  
If you have trouble printing, see [Printing Problems](#).

## Application Notes

Title	Size (in Kbytes)	Date	 View Online	 Download	 Receive via Email
<b>AP-SO:</b> Reliability Reports Update Small Outline (SO) Package	109 Kbytes	4-Nov-95	<a href="#">View Online</a>	<a href="#">Download</a>	<a href="#">Receive via Email</a>
<b>AN-127:</b> LM 143 Monolithic High Voltage Operational Amplifier Applications	248 Kbytes	4-Nov-95	<a href="#">View Online</a>	<a href="#">Download</a>	<a href="#">Receive via Email</a>
<b>AN-79:</b> IC Preamplifier Challenges Choppers on Drift	173 Kbytes	4-Nov-95	<a href="#">View Online</a>	<a href="#">Download</a>	<a href="#">Receive via Email</a>
<b>LB-19:</b> Predicting OP Amp Slew Rate Limited Response	89 Kbytes	28-Jun-96	<a href="#">View Online</a>	<a href="#">Download</a>	<a href="#">Receive via Email</a>
<b>AN-184:</b> References for A/D Converters	98 Kbytes	4-Nov-95	<a href="#">View Online</a>	<a href="#">Download</a>	<a href="#">Receive via Email</a>
References for A/D Converters ( <b>JAPANESE</b> )	124 Kbytes				

<b>AN-210:</b> New Phase-Locked-Loops Have Advantages as Frequency to Voltage Converters (and more)	183 Kbytes	4-Nov-95	<a href="#">View Online</a>	<a href="#">Download</a>	<a href="#">Receive via Email</a>
<b>AN-227:</b> Applications of Wide-Band Buffer Amplifiers	311 Kbytes	4-Nov-95	<a href="#">View Online</a>	<a href="#">Download</a>	<a href="#">Receive via Email</a>
<b>AN-48:</b> Applications for a New Ultra-High Speed Buffer	148 Kbytes	4-Nov-95	<a href="#">View Online</a>	<a href="#">Download</a>	<a href="#">Receive via Email</a>
<b>AN-480:</b> A 40 MHz Programmable Video Op Amp	181 Kbytes	4-Nov-95	<a href="#">View Online</a>	<a href="#">Download</a>	<a href="#">Receive via Email</a>
<b>AN-711:</b> Application Note 711 LM78S40 Switching Voltage Regulator Applications	346 Kbytes	2-Mar-99	<a href="#">View Online</a>	<a href="#">Download</a>	<a href="#">Receive via Email</a>
<b>AN-71:</b> Micropower Circuits Using the LM4250 Programmable Op Amp	195 Kbytes	4-Nov-95	<a href="#">View Online</a>	<a href="#">Download</a>	<a href="#">Receive via Email</a>
<b>AN-D:</b> Versatile Monolithic V/Fs Can Compute as Well as Convert with High Accuracy	169 Kbytes	4-Nov-95	<a href="#">View Online</a>	<a href="#">Download</a>	<a href="#">Receive via Email</a>
<b>LB-17:</b> LM118 Op Amp Slews 70V/microsecond	83 Kbytes	28-Jun-96	<a href="#">View Online</a>	<a href="#">Download</a>	<a href="#">Receive via Email</a>
<b>LB-42:</b> Get Fast Stable Response From Improved Unity-Gain Followers	83 Kbytes	28-Jun-96	<a href="#">View Online</a>	<a href="#">Download</a>	<a href="#">Receive via Email</a>

Please use [Adobe Acrobat](#) to view PDF file(s).  
If you have trouble printing, see [Printing Problems](#).

---

*[Information as of 18-Jul-2000]*

---

**Quick Search**

[Parametric Search](#)

[System Diagrams](#)

[Product Tree](#)

[Home](#)

[About Languages](#) . [About the Site](#) . [About "Cookies"](#)  
National is [QS 9000 Certified](#) . [Privacy/Security Copyright](#) © National Semiconductor Corporation

[Preferences](#) . [Feedback](#)