

100324

Low Power Hex TTL-to-ECL Translator

General Description

The 100324 is a hex translator, designed to convert TTL logic levels to 100K ECL logic levels. The inputs are compatible with standard or Schottky TTL. A common Enable (E), when LOW, holds all inverting outputs HIGH and holds all true outputs LOW. The differential outputs allow each circuit to be used as an inverting/non-inverting translator, or as a differential line driver. The output levels are voltage compensated over the full $-4.2V$ to $-5.7V$ range.

When the circuit is used in the differential mode, the 100324, due to its high common mode rejection, overcomes voltage gradients between the TTL and ECL ground systems. The V_{EE} and V_{TTL} power may be applied in either order.

The 100324 is pin and function compatible with the 100124 with similar AC performance, but features power dissipation roughly half of the 100124 to ease system cooling requirements.

Features

- Pin/function compatible with 100124
- Meets 100124 AC specifications
- 50% power reduction of the 100124
- Differential outputs
- 2000V ESD protection
- $-4.2V$ to $-5.7V$ operating range
- Standard Microcircuit Drawing (SMD) 5962-9153001

Logic Diagram

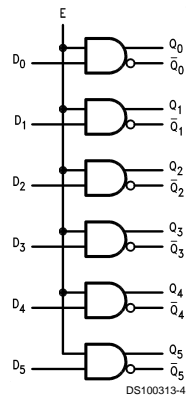

Pin Names	Description
D_0 – D_5	Data Inputs
E	Enable Input
Q_0 – Q_5	Data Outputs
$\overline{Q_0}$ – $\overline{Q_5}$	Complementary Data Outputs

Connection Diagrams

24-Pin DIP

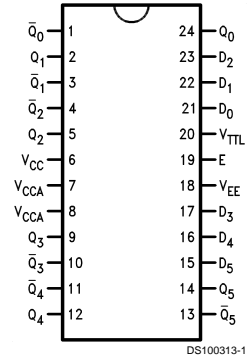

24-Pin Quad Cerpak

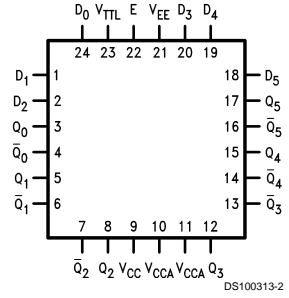

Absolute Maximum Ratings (Note 1)

If Military/Aerospace specified devices are required, please contact the National Semiconductor Sales Office/Distributors for availability and specifications.

Above which the useful life may be impaired.

Storage Temperature (T _{STG})	-65°C to +150°C
Maximum Junction Temperature (T _J)	
Ceramic	+175°C
V _{EE} Pin Potential to Ground Pin	-7.0V to +0.5V
V _{TTL} Pin Potential to Ground Pin	-0.5V to +6.0V
Input Voltage (DC)	-0.5V to +6.0V
Output Current (DC Output HIGH)	-50 mA

ESD (Note 2)

≥2000V

Recommended Operating Conditions

Case Temperature (T _C)	
Military	-55°C to +125°C
Supply Voltage (V _{EE})	-5.7V to -4.2V

Note 1: Absolute maximum ratings are those values beyond which the device may be damaged or have its useful life impaired. Functional operation under these conditions is not implied.

Note 2: ESD testing conforms to MIL-STD-883, Method 3015.

Military Version

DC Electrical Characteristics

V_{EE} = -4.2V to -5.7V, V_{CC} = V_{CCA} = GND, T_C = -55°C to +125°C, V_{TTL} = +4.5V to +5.5V

Symbol	Parameter	Min	Max	Units	T _C	Conditions	Notes
V _{OH}	Output HIGH Voltage	-1025	-870	mV	0°C to +125°C	V _{IN} = V _{IH} (Max) or V _{IL} (Min) Loading with 50Ω to -2.0V	(Notes 3, 4, 5)
		-1085	-870	mV	-55°C		
V _{OL}	Output LOW Voltage	-1830	-1620	mV	0°C to +125°C		
		-1830	-1555	mV	-55°C		
V _{OHC}	Output HIGH Voltage	-1035		mV	0°C to +125°C	V _{IN} = V _{IH} (Max) or V _{IL} (Min) Loading with 50Ω to -2.0V	(Notes 3, 4, 5)
		-1085		mV	-55°C		
V _{OLC}	Output LOW Voltage		-1610	mV	0°C to +125°C		
			-1555	mV	-55°C		
V _{IH}	Input HIGH Voltage	2.0	5.0	V	-55°C to +125°C	Over V _{TTL} , V _{EE} , T _C Range	(Notes 3, 4, 5, 6)
V _{IL}	Input LOW Voltage	0.0	0.8	V	-55°C to +125°C	Over V _{TTL} , V _{EE} , T _C Range	(Notes 3, 4, 5, 6)
I _{IH}	Input HIGH Current Breakdown Test		20	μA	-55°C to +125°C	V _{IN} = +2.7V	(Notes 3, 4, 5)
			100	μA	-55°C to +125°C	V _{IN} = +7.0V	
I _{IL}	Input LOW Current Data Enable	-0.9		mA	-55°C to +125°C	V _{IN} = +0.4V	(Notes 3, 4, 5)
		-5.4					
V _{FCD}	Input Clamp Diode Voltage		-1.2	V	-55°C to +125°C	I _{IN} = -18 mA	(Notes 3, 4, 5)
I _{EE}	V _{EE} Power Supply Current	-70	-22	mA	-55°C to +125°C	All Inputs V _{IN} = +4.0V	(Notes 3, 4, 5)
I _{TTL}	V _{TTL} Power Supply Current		38	mA	-55°C to +125°C	All Inputs V _{IN} = GND	(Notes 3, 4, 5)

Note 3: F100K 300 Series cold temperature testing is performed by temperature soaking (to guarantee junction temperature equals -55°C), then testing immediately without allowing for the junction temperature to stabilize due to heat dissipation after power-up. This provides "cold start" specs which can be considered a worst case condition at cold temperatures.

Note 4: Screen tested 100% on each device at -55°C, +25°C, and +125°C, Subgroups 1, 2, 3, 7, and 8.

Note 5: Sample tested (Method 5005, Table I) on each manufactured lot at -55°C, +25°C, and +125°C, Subgroups A1, 2, 3, 7, and 8.

Note 6: Guaranteed by applying specified input condition and testing V_{OH}/V_{OL}.

AC Electrical Characteristics

V_{EE} = -4.2V to -5.7V, V_{CC} = V_{CCA} = GND, V_{TTL} = +4.5V to +5.5V

Symbol	Parameter	T _C = -55°C		T _C = +25°C		T _C = +125°C		Units	Conditions	Notes
		Min	Max	Min	Max	Min	Max			
t _{PLH}	Propagation Delay	0.50	3.00	0.50	2.90	0.30	3.30	ns	Figures 1, 2	(Notes 7, 8, 9)
t _{PHL}	Data and Enable to Output									
t _{TLH}	Transition Time	0.35	1.80	0.45	1.80	0.45	1.80	ns		(Note 10)
t _{THL}	20% to 80%, 80% to 20%									

Note 7: F100K 300 Series cold temperature testing is performed by temperature soaking (to guarantee junction temperature equals -55°C), then testing immediately after power-up. This provides "cold start" specs which can be considered a worst case condition at cold temperatures.

Note 8: Screen tested 100% on each device at +25°C temperature only, Subgroup A9.

Note 9: Sample tested (Method 5005, Table I) on each manufactured lot at +25°C, Subgroup A9, and at +125°C and -55°C temperatures, Subgroups A10 and A11.

Note 10: Not tested at +25°C, +125°C, and -55°C temperature (design characterization data).

Switching Waveform

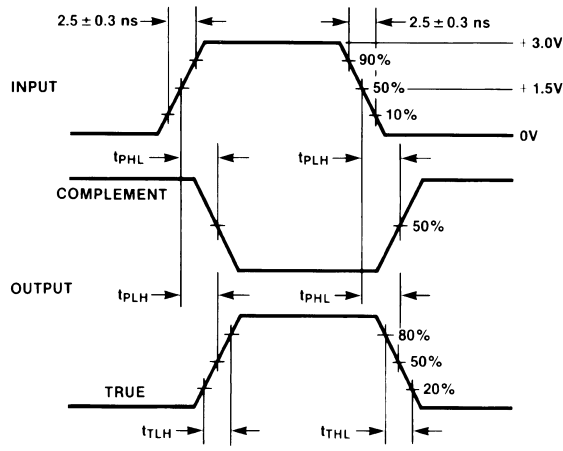

DS100313-6

FIGURE 1. Propagation Delay and Transition Times

Test Circuit

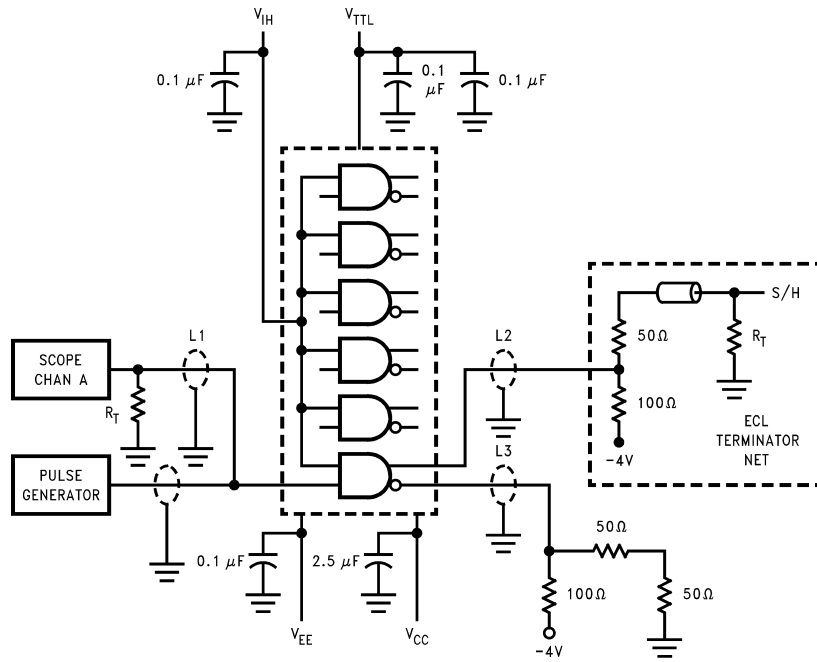

DS100313-5

Note:

$V_{CC}, V_{CCA} = 0V, V_{EE} = -4.5V, V_{TTL} = +5.0V, V_{IH} = +3.0V$

$L1, L2$ and $L3$ = equal length 50Ω impedance lines

$R_T = 50 \Omega$ terminator internal to scope

Decoupling $0.1 \mu F$ from GND to V_{CC}, V_{EE} and V_{TTL}

All unused outputs are loaded with 50Ω to $-2V$ or with equivalent ECL terminator network

C_L = Fixture and stray capacitance ≤ 3 pF

FIGURE 2. AC Test Circuit

Physical Dimensions inches (millimeters) unless otherwise noted

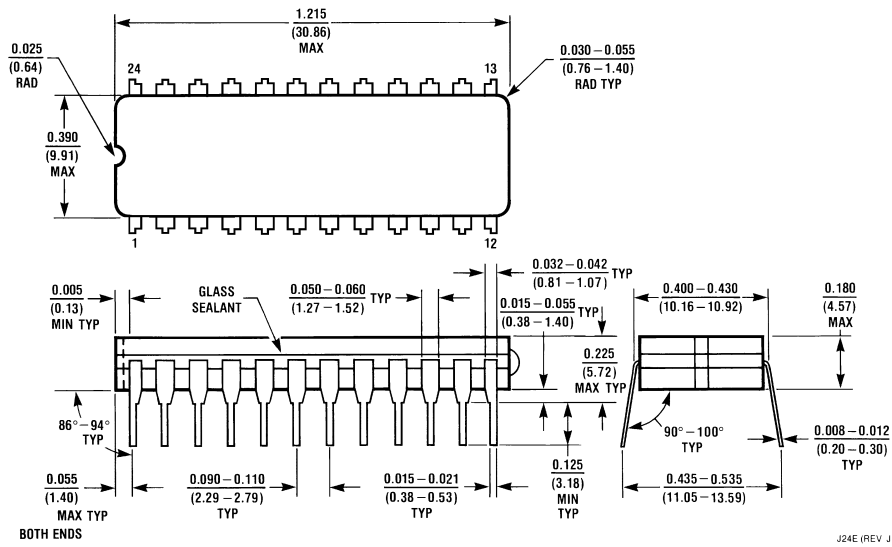

24-Lead Ceramic Dual-In-Line Package (0.400" Wide) (D)
NS Package Number J24E

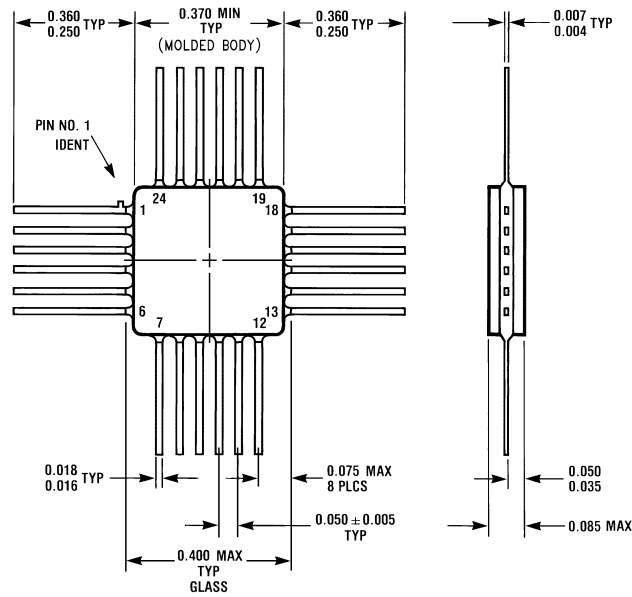

24 Lead Quad Cerpak (F)
NS Package Number W24B

LIFE SUPPORT POLICY

NATIONAL'S PRODUCTS ARE NOT AUTHORIZED FOR USE AS CRITICAL COMPONENTS IN LIFE SUPPORT DEVICES OR SYSTEMS WITHOUT THE EXPRESS WRITTEN APPROVAL OF THE PRESIDENT OF NATIONAL SEMICONDUCTOR CORPORATION. As used herein:

1. Life support devices or systems are devices or systems which, (a) are intended for surgical implant into the body, or (b) support or sustain life, and whose failure to perform when properly used in accordance with instructions for use provided in the labeling, can be reasonably expected to result in a significant injury to the user.
2. A critical component in any component of a life support device or system whose failure to perform can be reasonably expected to cause the failure of the life support device or system, or to affect its safety or effectiveness.



National Semiconductor Corporation
Americas
Tel: 1-800-272-9959
Fax: 1-800-737-7018
Email: support@nsc.com

www.national.com

National Semiconductor Europe
Fax: +49 (0) 1 80-530 85 86
Email: europe.support@nsc.com
Deutsch Tel: +49 (0) 1 80-530 85 85
English Tel: +49 (0) 1 80-532 78 32
Français Tel: +49 (0) 1 80-532 93 58
Italiano Tel: +49 (0) 1 80-534 16 80

National Semiconductor Asia Pacific Customer Response Group
Tel: 65-2544466
Fax: 65-2504466
Email: sea.support@nsc.com

National Semiconductor Japan Ltd.
Tel: 81-3-5620-6175
Fax: 81-3-5620-6179

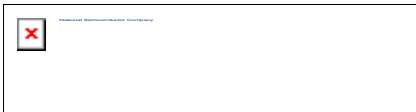

100324 Low Power Hex TTL-to-ECL Translator

Contents

- [General Description](#)
- [Features](#)
- [Datasheet](#)
- [Package Availability, Models, Samples & Pricing](#)

General Description

The 100324 is a hex translator, designed to convert TTL logic levels to 100K ECL logic levels. The inputs are compatible with standard or Schottky TTL. A common Enable (E), when LOW, holds all inverting outputs HIGH and holds all true outputs LOW. The differential outputs allow each circuit to be used as an inverting/non-inverting translator, or as a differential line driver. The output levels are voltage compensated over the full -4.2V to -5.7V range.



When the circuit is used in the differential mode, the 100324, due to its high common mode rejection, overcomes voltage gradients between the TTL and ECL ground systems. The V_{EE} and V_{TTL} power may be applied in either order.

The 100324 is pin and function compatible with the 100124 with similar AC performance, but features power dissipation roughly half of the 100124 to ease system cooling requirements.

Features



- Pin/function compatible with 100124
- Meets 100124 AC specifications
- 50% power reduction of the 100124
- Differential outputs
- 2000V ESD protection
- -4.2V to -5.7V operating range
- Standard Microcircuit Drawing (SMD) 5962-9153001

Datasheet

Title	Size (in Kbytes)	Date	 View Online	 Download	 Receive via Email
100324 Low Power Hex TTL-to-ECL Translator	117 Kbytes	4-Sep-98	View Online	Download	Receive via Email
100324 Mil-Aero Datasheet MN100324-X	79 Kbytes		View Online	Download	Receive via Email

Please use [Adobe Acrobat](#) to view PDF file(s).
If you have trouble printing, see [Printing Problems](#).

Package Availability, Models, Samples & Pricing

Part Number	Package		Status	Models		Samples & Electronic Orders	Budgetary Pricing		Std Pack Size	Package Marking
	Type	# pins		SPICE	IBIS		Quantity	\$US each		
5962-9153001MXA	Cerdip	24	Full production	N/A	N/A		50+	\$37.6000	tube of 15	[logo]çZçSç4çA\$E 100324DMQB /Q 5962-9153001MXA
5962-9153001MYA	Cerquad	24	Full production	N/A	N/A		50+	\$40.7000	tube of 14	[logo]çZçSç4çA Q\$E 100324 FMQB 5962 -9153001 MYA

5962-9153001VXA	Cerdip	24	Full production	N/A	N/A	.	50+	\$265.0000	tube of 15	[logo]çZçSç4çA\$E 100324J-QMLV 5962-9153001VXA
5962-9153001VYA	Cerquad	24	Full production	N/A	N/A		50+	\$265.0000	tube of 14	[logo]çZçSç4çA 100324W- QMLV 5962 -9153001 VYA \$E
100324 MW8	wafer		Full production	N/A	N/A	.			N/A	-

[Information as of 1-Sep-2000]

Quick Search

[Parametric Search](#)

[System Diagrams](#)

[Product Tree](#)

[Home](#)

[About Languages](#) . [About the Site](#) . [About "Cookies"](#)

National is [QS 9000 Certified](#) . [Privacy/Security](#)

[Copyright](#) © National Semiconductor Corporation

[Preferences](#) . [Feedback](#)