

## 150mA, $\mu$ Cap, Low Dropout Voltage Regulator with Power Good

### General Description

The LMS5258 is a  $\mu$ Cap, precise CMOS voltage regulator with power good output.

It provides up to 150mA and consumes a typical of 10nA in shutdown mode. The LMS5258 output stage is designed with a push pull output for faster transient response.

The LMS5258 is optimized to work with low value, low cost ceramic capacitors. The output typically require only  $1\mu\text{F}$  of output capacitance for stability. The enable pin can be tied to  $V_{\text{IN}}$  for easy device layout.

The LMS5258 is designed for portable, battery powered equipment applications with small space requirements.

The LMS5258 is available in a 5-pin SOT-23 package. Performance is specified for the  $-40^{\circ}\text{C}$  to  $+125^{\circ}\text{C}$  temperature range and is available in a fixed 1.2V. For other output voltage options, please contact National Semiconductor.

### Features

- Power good indicator
- Stability with low ESR capacitors
- Low ground current: 120 $\mu\text{A}$
- 150mA output current
- "Zero" shutdown mode current
- Fast transient response
- Auto Discharge
- Thermal shutdown
- Current limiting
- TTL-Logic-controlled enable input
- Pin-to-pin replacement for MIC5258

### Applications

- Processor power-up sequencing
- Laptop, notebook and palm top computer
- PCMCIA  $V_{\text{CC}}$  and  $V_{\text{PP}}$  regulation switching

### Typical Application

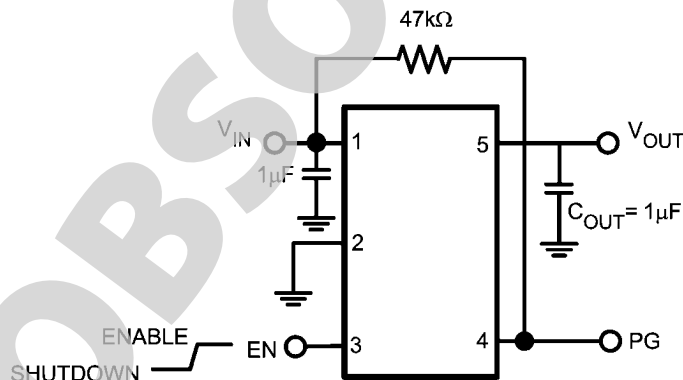

20042419

### Pin Descriptions

Pin Number	Pin Name	Pin Function
1	$V_{\text{IN}}$	Input Voltage
2	GND	Ground
3	EN	Enable Input Logic, Logic High = Enabled Logic Low = Shutdown (Do not leave open)
4	PG	Power Good Output
5	$V_{\text{OUT}}$	Output Voltage

## Connection Diagram

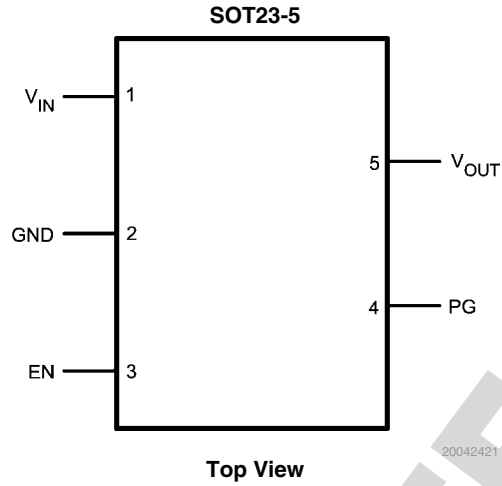

## Ordering Information

Package	Part Number	Package Marking	Transport Media	NSC Drawing
5-Pin SOT-23	LMS5258MF-1.2	LF9B	1k Units Tape and Reel	MF05A
	LMS5258MFX-1.2		3k Units Tape and Reel	

OBSOLETE

## Absolute Maximum Ratings *(Note 1)*

If Military/Aerospace specified devices are required, please contact the National Semiconductor Sales Office/ Distributors for availability and specifications.

### ESD Tolerance *(Note 2)*

Human Body Model	2000V
Junction Temperature	150°C
$V_{IN}$ , $V_{OUT}$ , $V_{EN}$	-0.3 TO 6.5V
Soldering Information	

Infrared or Convection (20 sec)	235°C
Wave Soldering (10 sec)	260°C (lead temp)

## Operating Ratings

Supply Voltages	
$V_{IN}$	2.7V to 6V
$V_{EN}$	0V to $V_{IN}$
Junction Temp. Range <i>(Note 3)</i>	-40°C to +125°C
Storage Temperature Range	-65°C to 150°C
Package Thermal Resistance	
SOT23-5	235°C/W

## Electrical Characteristics

Unless otherwise specified, all limits guaranteed for  $T_J = 25^\circ\text{C}$ ,  $V_{IN} = 2.7\text{V}$ ,  $I_L = 100\mu\text{A}$ ,  $C_{OUT} = 1\mu\text{F}$ ,  $V_{EN} \geq 2.0\text{V}$ . **Boldface** limits apply over the entire operating temperature range, -40°C to 125°C.

Symbol	Parameter	Conditions	Min <i>(Note 5)</i>	Typ <i>(Note 4)</i>	Max <i>(Note 5)</i>	Units
$V_O$	Output Voltage Accuracy		-3 <b>-4</b>		3 <b>4</b>	%
$\Delta V_O/V_O$	Line Regulation	$V_{IN} = 2.7\text{V}$ to 6V	<b>-0.3</b>		<b>0.3</b>	%
$\Delta V_O/V_O$	Load Regulation	$I_L = 0.1\text{mA}$ to 150mA <i>(Note 6)</i>		1	4	%
$I_Q$	Quiescent Current	$V_{EN} \leq 0.4\text{V}$ (Shutdown), PG = NC		.01	1	$\mu\text{A}$
$I_{GND}$	Ground Pin Current <i>(Note 5)</i>	$V_{EN} \geq 2.0\text{V}$ (active), $V_{IN} = 6\text{V}$ , $I_L = 0\text{mA}$		120	180	$\mu\text{A}$
		$I_L = 150\text{mA}$ , $V_{EN} \geq 2.0\text{V}$ (active), $V_{IN} = 6\text{V}$		160	225	
PSRR	Power Supply Rejection	$f = 120\text{Hz}$ , $C_{OUT} = 4.7\mu\text{F}$ , $I_L = 150\text{mA}$		62		dB
$I_{LIMIT}$	Current Limit	$V_{OUT} = 0\text{V}$	160	350		mA
<b>Thermal Protection</b>						
	Thermal Shutdown Temperature			150		°C
<b>Enable Input</b>						
$V_{IL}$	Enable Input Voltage Level	Logic Low (off), $V_{IN} = 5.5\text{V}$			<b>0.4</b>	V
$V_{IH}$		Logic High (on), $V_{IN} = 5.5\text{V}$	<b>2</b>			V
$I_{IL}$	Enable Input Current	$V_{IL} \leq 0.4\text{V}$ , $V_{IN} = 5.5\text{V}$		0.01		$\mu\text{A}$
$I_{IH}$		$V_{IH} \geq 2.0\text{V}$ , $V_{IN} = 5.5\text{V}$		0.01		$\mu\text{A}$
<b>Power Good</b>						
$V_{PG}$	Low Threshold	% of $V_{OUT}$ (PG ON)	89			%
	High Threshold	% of $V_{OUT}$ (PG OFF)			97	
$V_{OL}$	PG Output Logic-Low Voltage	Ipowersgood = 100 $\mu\text{A}$ , Fault Condition		0.02	0.1	V
$I_{PG}$	Power Good Leakage Current	Power Good Off, $V_{PG} = 5.5\text{V}$		0.01		$\mu\text{A}$
$V_{PG}$ Delay	Delay Time to Power Good	See Timing Diagram	1		5	ms

**Note 1:** Absolute Maximum Ratings indicate limits beyond which damage to the device may occur. Operating Ratings indicate conditions for which the device is intended to be functional, but specific performance is not guaranteed. For guaranteed specifications and the test conditions, see the Electrical Characteristics.

**Note 2:** Human body model, 1.5k $\Omega$  in series with 100pF.

**Note 3:** The maximum power dissipation is a function of  $T_{J(MAX)}$ ,  $\theta_{JA}$ , and  $T_A$ . The maximum allowable power dissipation at any ambient temperature is  $P_D = (T_{J(MAX)} - T_A)/\theta_{JA}$ . All numbers apply for packages soldered directly into a PC board.

**Note 4:** Typical Values represent the most likely parametric norm.

**Note 5:** All limits are guaranteed by testing or statistical analysis.

**Note 6:** Regulation is measured at constant junction temperature using low duty cycle pulse testing.

**Note 7:** Ground pin current is the regulator quiescent current. The total current drawn from the supply is the sum of the load current plus the ground pin current.

# Timing Diagram

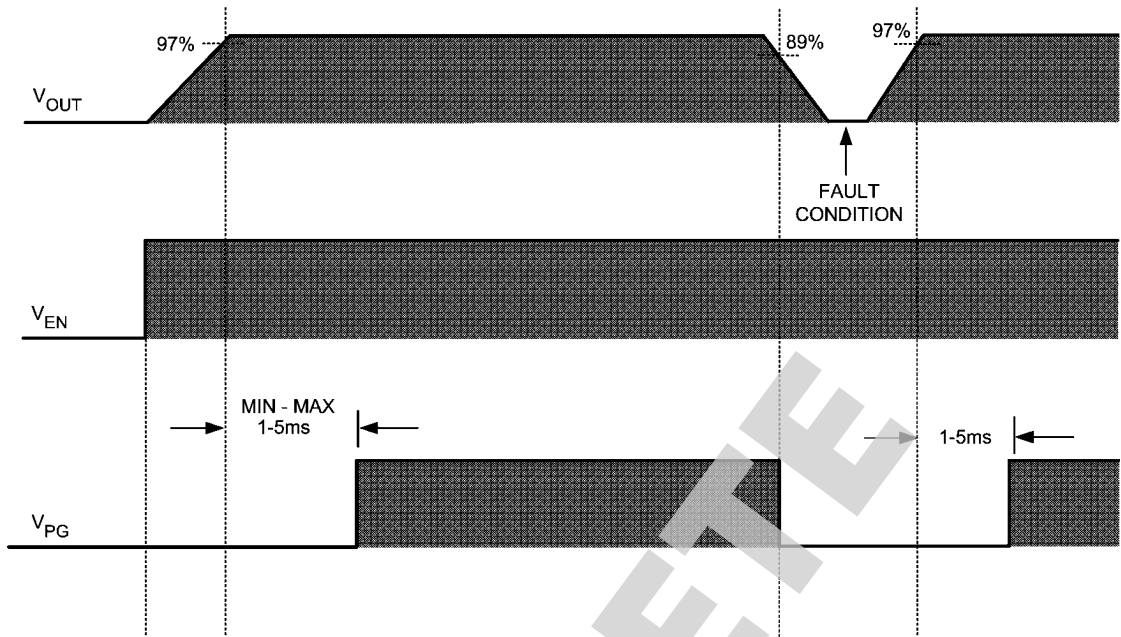

20042415

OBSOLETE

# Block Diagram

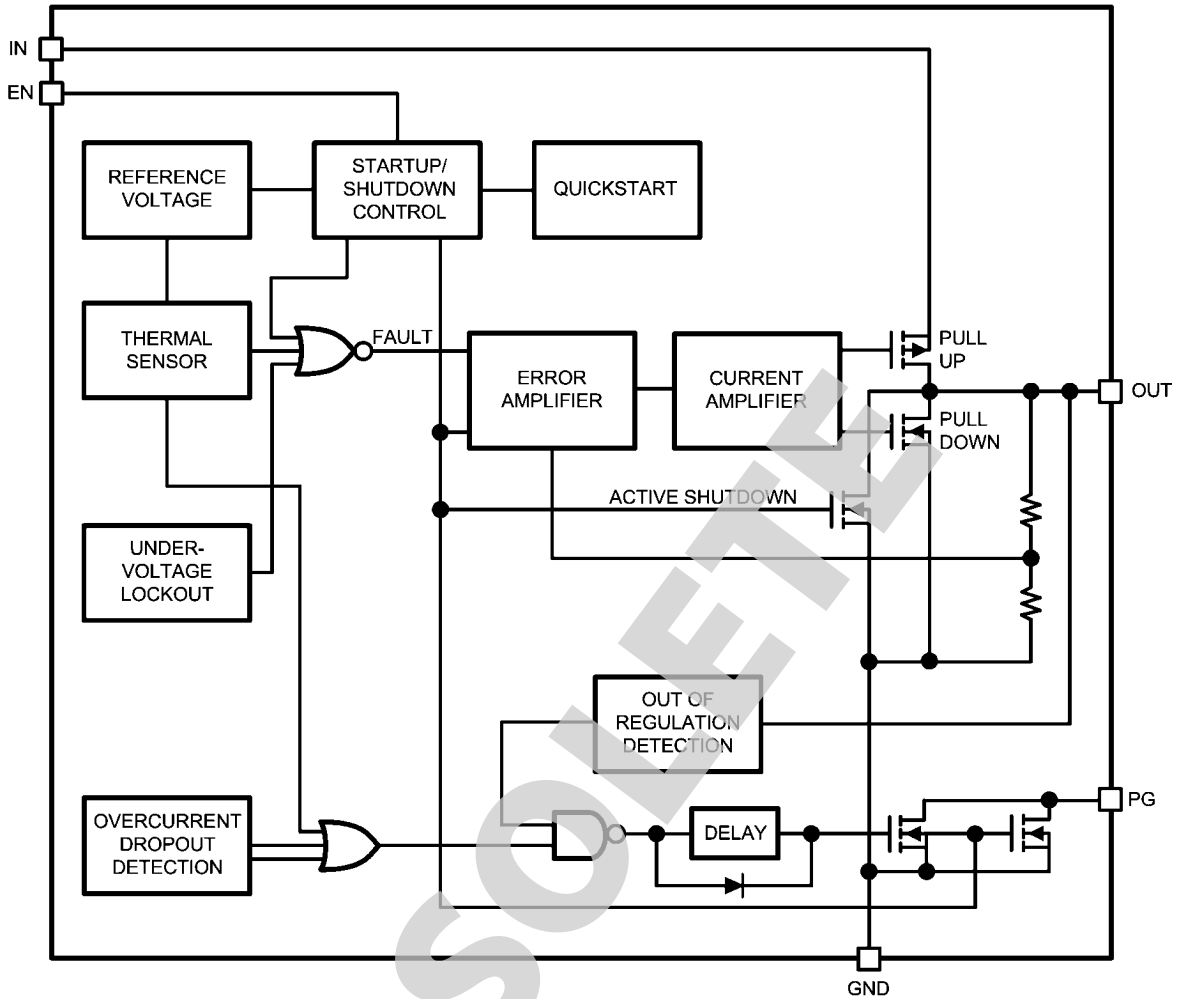

20042420

## Typical Performance Characteristics

and powergood pull up resistor = 47kΩ.

Unless otherwise specified,  $V_{IN} = 3.3V$ ,  $C_{OUT} = 1\mu F$ ,  $T_A = 25^\circ C$

Ground Current vs. Output Current

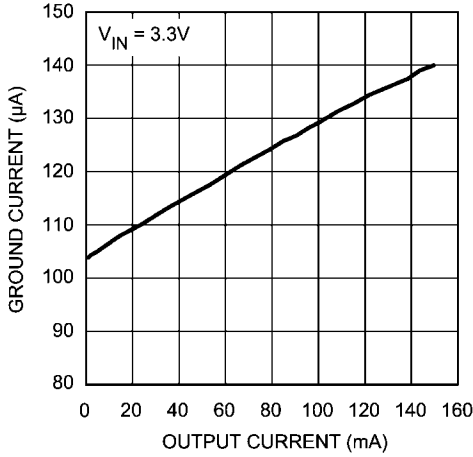

20042401

Ground Current vs. Input Voltage

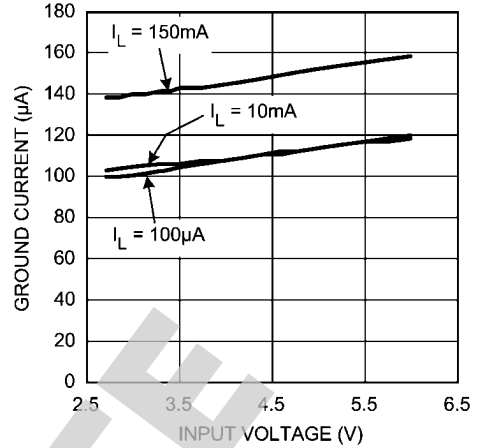

20042402

Ground Current vs. Temperature

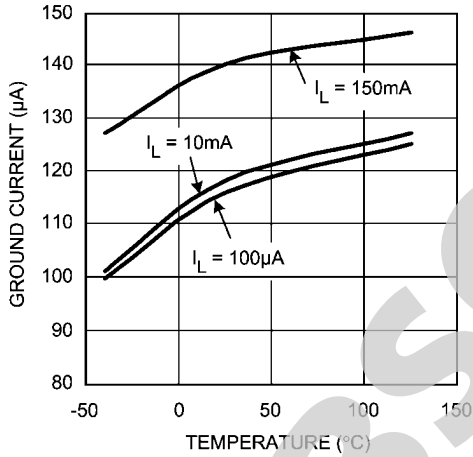

20042403

Short Circuit Current vs. Temperature ( $V_{IN} = 3.3V$ )

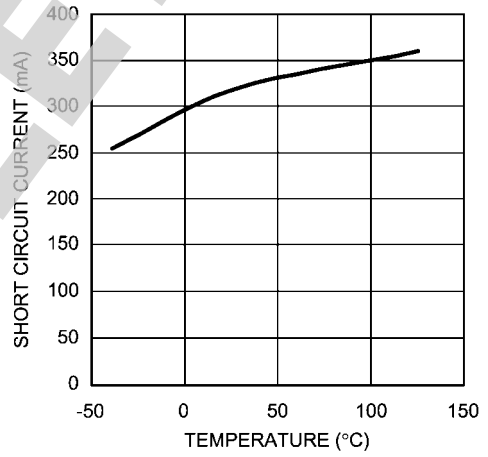

20042404

Short Circuit Current vs. Input Voltage

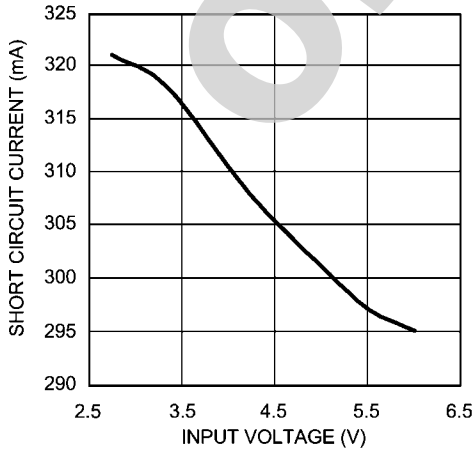

20042405

Power Good Delay vs. Input Voltage ( $I_L = 100\mu A$ )

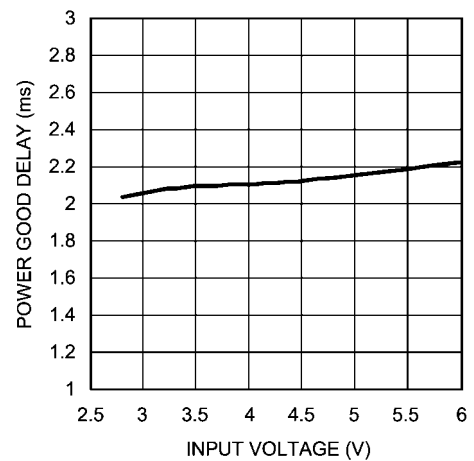

20042406

Power Good Delay vs. Temperature ( $V_{IN} = 3.3V$ )

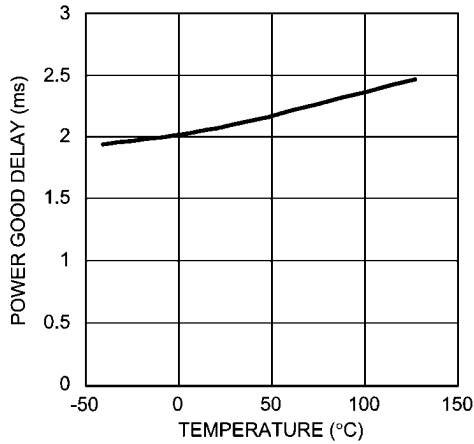

20042407

Output Voltage vs. Temperature

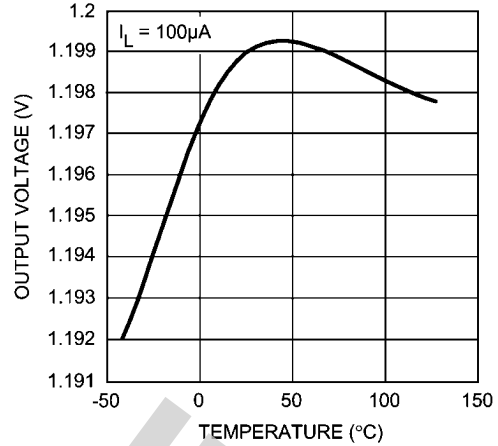

20042408

Output Voltage vs. Input Voltage

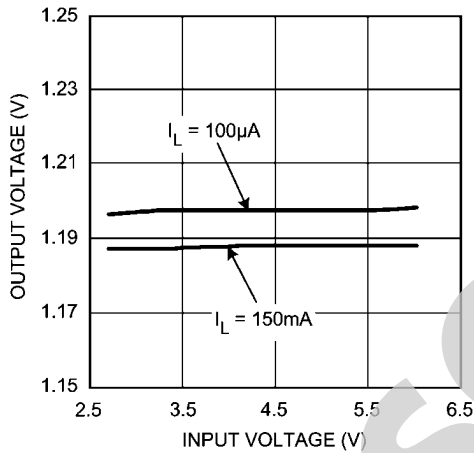

20042409

Output Voltage vs. Output Current

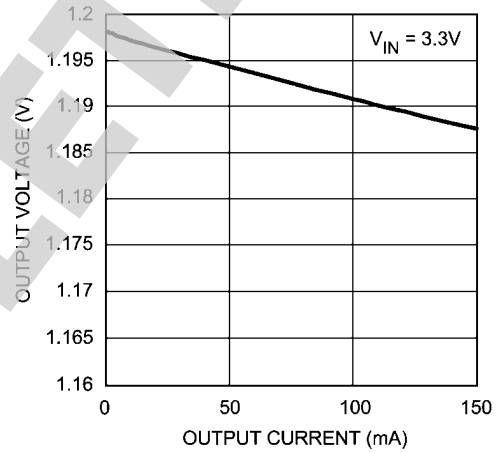

20042411

Enable Voltage vs. Input Voltage

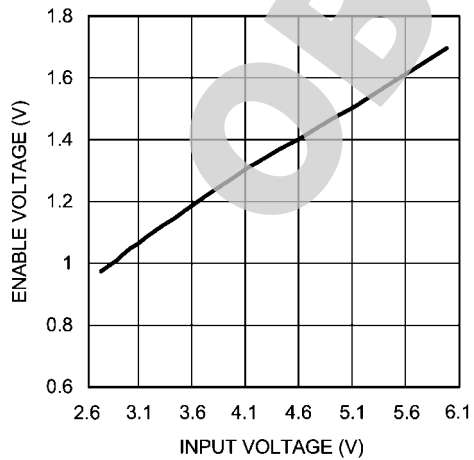

20042422

Enable Voltage vs. Temperature

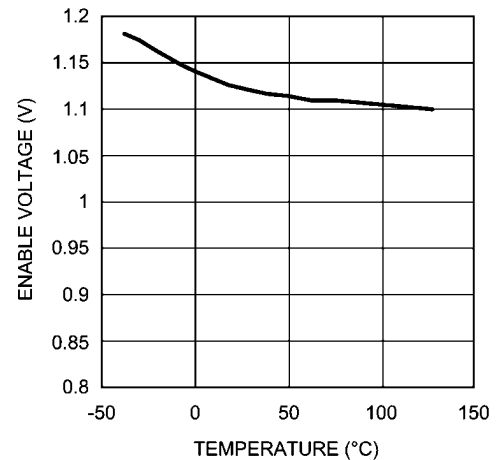

20042423

Power Good Pull-Up Resistor vs. Power Good

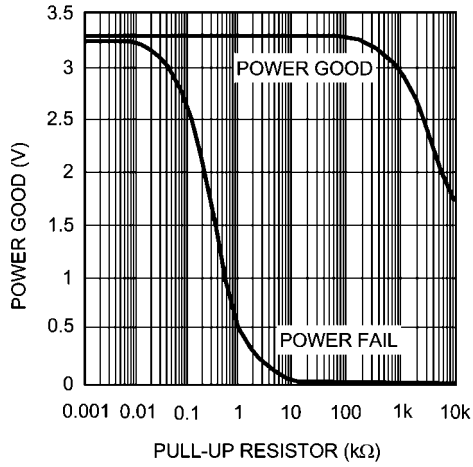

20042416

Voltage Noise vs. Frequency

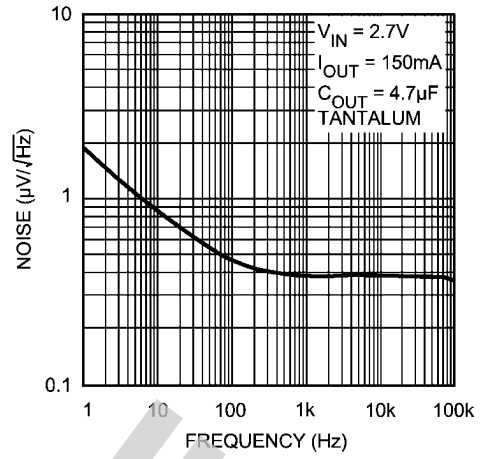

20042412

PSRR vs. Frequency

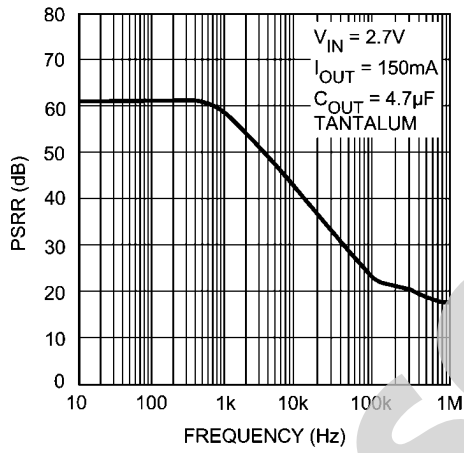

20042413

Power On Reset Delay Time

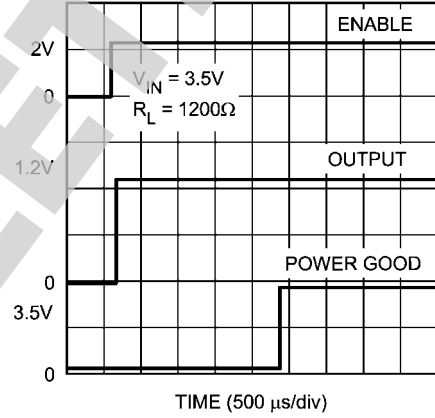

20042414



## Application Notes

LMS5258 is a linear regulator designed to be used with a low ESR, low cost ceramic capacitors.

### EXTERNAL CAPACITORS

The LMS5258 regulator requires an output capacitor to maintain stability. The capacitor must be at least 1 $\mu$ F or greater. The capacitor can be low-ESR ceramic chip capacitor, however for improved capacitance over temperature, tantalum capacitors can be used.

A 1 $\mu$ F input capacitor is recommended when the supply capacitance is more than 10 inches away from the device, or when the supply is a battery.

X7R dielectric ceramic capacitors are recommended because of their temperature performance. X7R-type capacitors change capacitance by 15% over their operating temperature range and are the most stable type of ceramic capacitors. Z5U and Y5V dielectric capacitors change value by as much 50% and 60% respectively over their operating temperature range. To use a ceramic chip capacitor with Y5V dielectric, the value must be much higher than an X7R ceramic or a tantalum capacitor to ensure the same minimum capacitance value over the operating temperature range. Tantalum capacitors have a very stable dielectric (10% over their operating temperature range) and can also be used with this device.

### ENABLE/SHUTDOWN

The LMS5258 has an active high enable pin that allows the regulator to be disabled. Applying a Logic Level low (<0.4 V) to the Shutdown pin will cause the output to turn off, in this state current consumed by the regulator goes nearly to zero. Applying a logic level high (>2.0) enables the output voltage. The enable/shutdown pin can't be left floating; a floating enable pin may cause an indeterminate state on the output.

### ACTIVE SHUTDOWN

The LMS5258 designed with a N-channel MOSFET that acts as a shutdown clamp. The N-channel turns on when the device is disabled to allow the output capacitor and load to discharge.

### POWER GOOD

The power good output is an open-drain output. It is designed essentially to work as a power-on reset generator once the regulated voltage was up and/ or a fault condition. When a

fault condition and an undervoltage detection occur, the output of the power good pin goes low. The power good output comes back up once the output has reached 97% of its nominal value and 1ms to 5ms delay has passed, see timing diagram.

The LMS5258 internal circuit monitors overcurrent, temperature and falling output voltage. If one of these conditions is flagged that indicates a fault condition.

The flagged condition output is fed into an onchip delay circuit that drives the open drain output transistor.

### TRANSIENT RESPONSE

The LMS5258 implements a unique output stage to dramatically improve transient response recovery time. The output is a totem-pole configuration with a P-channel MOSFET pass device and a N-channel MOSFET clamp. The N-channel clamp is a significantly smaller device that prevents the output voltage from overshooting when a heavy load is removed. This feature helps to speed up the transient response by significantly decreasing transient response recovery time during the transition from heavy load to light load.

### THERMAL BEHAVIOR

The LMS5258 regulator has internal thermal shutdown to protect the device from over heating. Under all operating conditions, the maximum junction temperature of the LMS5258 must be below 125°C. Maximum power dissipation can be calculated based on the output current and the voltage drop across the part. The maximum power dissipation is

$$P_{D(MAX)} = (T_{J(MAX)} - T_A) / \theta_{JA}$$

$\theta_{JA}$  is the junction-to-ambient thermal resistance, 235°C/W for the LMS5258 in the SOT23-5 package.  $T_A$  is the maximum ambient temperature  $T_{J(MAX)}$  is the maximum junction temperature of the die, 125°C.

When operating the LMS5258 at room temperature, the maximum power dissipation is 425mW.

The actual power dissipated by the regulator is

$$P_D = (V_{IN} - V_{OUT}) I_L + V_{IN} I_{GND}$$

Substituting  $P_{D(MAX)}$ , determined above, for  $P_D$  and solving for the operating condition that are critical to the application will give the maximum operating conditions for the regulator circuit. To prevent the device from entering thermal shutdown, maximum power dissipation cannot be exceeded.

**Physical Dimensions** inches (millimeters) unless otherwise noted

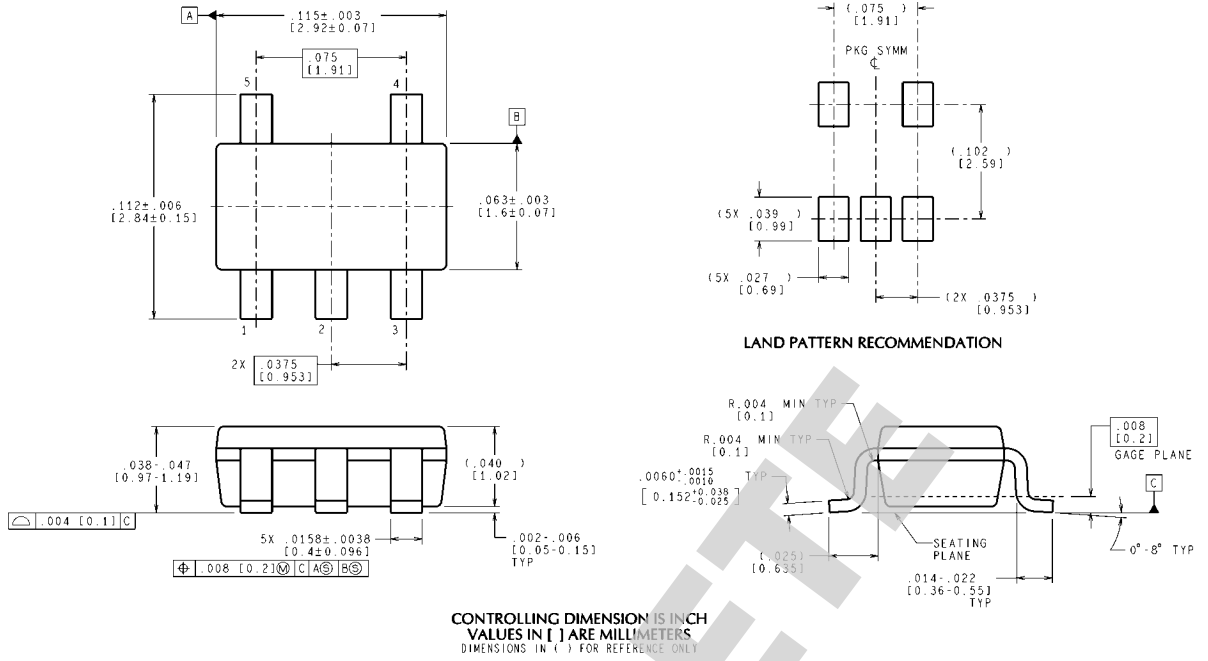

CONTROLLING DIMENSION IS INCH  
VALUES IN [ ] ARE MILLIMETERS  
DIMENSIONS IN ( ) FOR REFERENCE ONLY

**5-Pin SOT23-5**  
**NSC Package Number MF05A**

MF05A (Rev D)

OBSOLETE

# Notes

LMS5258

**OBSOLETE**

## Notes

For more National Semiconductor product information and proven design tools, visit the following Web sites at:  
[www.national.com](http://www.national.com)

Products		Design Support	
Amplifiers	<a href="http://www.national.com/amplifiers">www.national.com/amplifiers</a>	WEBENCH® Tools	<a href="http://www.national.com/webench">www.national.com/webench</a>
Audio	<a href="http://www.national.com/audio">www.national.com/audio</a>	App Notes	<a href="http://www.national.com/appnotes">www.national.com/appnotes</a>
Clock and Timing	<a href="http://www.national.com/timing">www.national.com/timing</a>	Reference Designs	<a href="http://www.national.com/refdesigns">www.national.com/refdesigns</a>
Data Converters	<a href="http://www.national.com/adc">www.national.com/adc</a>	Samples	<a href="http://www.national.com/samples">www.national.com/samples</a>
Interface	<a href="http://www.national.com/interface">www.national.com/interface</a>	Eval Boards	<a href="http://www.national.com/evalboards">www.national.com/evalboards</a>
LVDS	<a href="http://www.national.com/lvds">www.national.com/lvds</a>	Packaging	<a href="http://www.national.com/packaging">www.national.com/packaging</a>
Power Management	<a href="http://www.national.com/power">www.national.com/power</a>	Green Compliance	<a href="http://www.national.com/quality/green">www.national.com/quality/green</a>
Switching Regulators	<a href="http://www.national.com/switchers">www.national.com/switchers</a>	Distributors	<a href="http://www.national.com/contacts">www.national.com/contacts</a>
LDOs	<a href="http://www.national.com/ldo">www.national.com/ldo</a>	Quality and Reliability	<a href="http://www.national.com/quality">www.national.com/quality</a>
LED Lighting	<a href="http://www.national.com/led">www.national.com/led</a>	Feedback/Support	<a href="http://www.national.com/feedback">www.national.com/feedback</a>
Voltage References	<a href="http://www.national.com/vref">www.national.com/vref</a>	Design Made Easy	<a href="http://www.national.com/easy">www.national.com/easy</a>
PowerWise® Solutions	<a href="http://www.national.com/powerwise">www.national.com/powerwise</a>	Applications & Markets	<a href="http://www.national.com/solutions">www.national.com/solutions</a>
Serial Digital Interface (SDI)	<a href="http://www.national.com/sdi">www.national.com/sdi</a>	Mil/Aero	<a href="http://www.national.com/milaero">www.national.com/milaero</a>
Temperature Sensors	<a href="http://www.national.com/tempensors">www.national.com/tempensors</a>	SolarMagic™	<a href="http://www.national.com/solarmagic">www.national.com/solarmagic</a>
PLL/VCO	<a href="http://www.national.com/wireless">www.national.com/wireless</a>	PowerWise® Design University	<a href="http://www.national.com/training">www.national.com/training</a>

THE CONTENTS OF THIS DOCUMENT ARE PROVIDED IN CONNECTION WITH NATIONAL SEMICONDUCTOR CORPORATION ("NATIONAL") PRODUCTS. NATIONAL MAKES NO REPRESENTATIONS OR WARRANTIES WITH RESPECT TO THE ACCURACY OR COMPLETENESS OF THE CONTENTS OF THIS PUBLICATION AND RESERVES THE RIGHT TO MAKE CHANGES TO SPECIFICATIONS AND PRODUCT DESCRIPTIONS AT ANY TIME WITHOUT NOTICE. NO LICENSE, WHETHER EXPRESS, IMPLIED, ARISING BY ESTOPPEL OR OTHERWISE, TO ANY INTELLECTUAL PROPERTY RIGHTS IS GRANTED BY THIS DOCUMENT.

TESTING AND OTHER QUALITY CONTROLS ARE USED TO THE EXTENT NATIONAL DEEMS NECESSARY TO SUPPORT NATIONAL'S PRODUCT WARRANTY. EXCEPT WHERE MANDATED BY GOVERNMENT REQUIREMENTS, TESTING OF ALL PARAMETERS OF EACH PRODUCT IS NOT NECESSARILY PERFORMED. NATIONAL ASSUMES NO LIABILITY FOR APPLICATIONS ASSISTANCE OR BUYER PRODUCT DESIGN. BUYERS ARE RESPONSIBLE FOR THEIR PRODUCTS AND APPLICATIONS USING NATIONAL COMPONENTS. PRIOR TO USING OR DISTRIBUTING ANY PRODUCTS THAT INCLUDE NATIONAL COMPONENTS, BUYERS SHOULD PROVIDE ADEQUATE DESIGN, TESTING AND OPERATING SAFEGUARDS.

EXCEPT AS PROVIDED IN NATIONAL'S TERMS AND CONDITIONS OF SALE FOR SUCH PRODUCTS, NATIONAL ASSUMES NO LIABILITY WHATSOEVER, AND NATIONAL DISCLAIMS ANY EXPRESS OR IMPLIED WARRANTY RELATING TO THE SALE AND/OR USE OF NATIONAL PRODUCTS INCLUDING LIABILITY OR WARRANTIES RELATING TO FITNESS FOR A PARTICULAR PURPOSE, MERCHANTABILITY, OR INFRINGEMENT OF ANY PATENT, COPYRIGHT OR OTHER INTELLECTUAL PROPERTY RIGHT.

#### LIFE SUPPORT POLICY

**NATIONAL'S PRODUCTS ARE NOT AUTHORIZED FOR USE AS CRITICAL COMPONENTS IN LIFE SUPPORT DEVICES OR SYSTEMS WITHOUT THE EXPRESS PRIOR WRITTEN APPROVAL OF THE CHIEF EXECUTIVE OFFICER AND GENERAL COUNSEL OF NATIONAL SEMICONDUCTOR CORPORATION.** As used herein:

Life support devices or systems are devices which (a) are intended for surgical implant into the body, or (b) support or sustain life and whose failure to perform when properly used in accordance with instructions for use provided in the labeling can be reasonably expected to result in a significant injury to the user. A critical component is any component in a life support device or system whose failure to perform can be reasonably expected to cause the failure of the life support device or system or to affect its safety or effectiveness.

National Semiconductor and the National Semiconductor logo are registered trademarks of National Semiconductor Corporation. All other brand or product names may be trademarks or registered trademarks of their respective holders.

Copyright© 2011 National Semiconductor Corporation

For the most current product information visit us at [www.national.com](http://www.national.com)



[www.national.com](http://www.national.com)

**National Semiconductor  
Americas Technical  
Support Center**  
Email: [support@nsc.com](mailto:support@nsc.com)  
Tel: 1-800-272-9959

**National Semiconductor Europe  
Technical Support Center**  
Email: [europe.support@nsc.com](mailto:europe.support@nsc.com)

**National Semiconductor Asia  
Pacific Technical Support Center**  
Email: [ap.support@nsc.com](mailto:ap.support@nsc.com)

**National Semiconductor Japan  
Technical Support Center**  
Email: [jpn.feedback@nsc.com](mailto:jpn.feedback@nsc.com)