

N-channel enhancement mode MOS transistor

BSH105

FEATURES

- Very low threshold voltage
- Fast switching
- Logic level compatible
- Subminiature surface mount package

SYMBOL

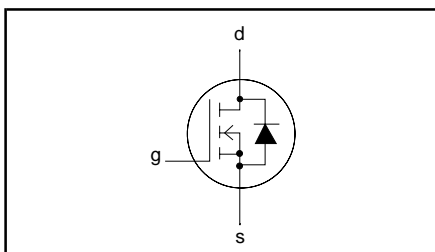

QUICK REFERENCE DATA

$V_{DS} = 20\text{ V}$
$I_D = 1.05\text{ A}$
$R_{DS(ON)} \leq 250\text{ m}\Omega$ ($V_{GS} = 2.5\text{ V}$)
$V_{GS(TO)} \geq 0.4\text{ V}$

GENERAL DESCRIPTION

N-channel, enhancement mode, logic level, field-effect power transistor. This device has very low threshold voltage and extremely fast switching making it ideal for battery powered applications and high speed digital interfacing.

The BSH105 is supplied in the SOT23 subminiature surface mounting package.

PINNING

PIN	DESCRIPTION
1	gate
2	source
3	drain

SOT23

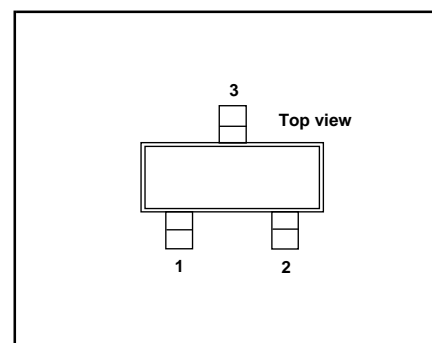

LIMITING VALUES

Limiting values in accordance with the Absolute Maximum System (IEC 134)

SYMBOL	PARAMETER	CONDITIONS	MIN.	MAX.	UNIT
V_{DS}	Drain-source voltage		-	20	V
V_{DGR}	Drain-gate voltage	$R_{GS} = 20\text{ k}\Omega$	-	20	V
V_{GS}	Gate-source voltage		-	± 8	V
I_D	Drain current (DC)	$T_a = 25\text{ }^\circ\text{C}$	-	1.05	A
		$T_a = 100\text{ }^\circ\text{C}$	-	0.67	A
I_{DM}	Drain current (pulse peak value)	$T_a = 25\text{ }^\circ\text{C}$	-	4.2	A
P_{tot}	Total power dissipation	$T_a = 25\text{ }^\circ\text{C}$	-	0.417	W
		$T_a = 100\text{ }^\circ\text{C}$	-	0.17	W
T_{stg}, T_j	Storage & operating temperature		- 55	150	$^\circ\text{C}$

THERMAL RESISTANCES

SYMBOL	PARAMETER	CONDITIONS	TYP.	MAX.	UNIT
$R_{th\ j-a}$	Thermal resistance junction to ambient	FR4 board, minimum footprint	300	-	K/W

N-channel enhancement mode MOS transistor

BSH105

ELECTRICAL CHARACTERISTICS

T_j = 25 °C unless otherwise specified

SYMBOL	PARAMETER	CONDITIONS	MIN.	TYP.	MAX.	UNIT
V _{(BR)DSS}	Drain-source breakdown voltage	V _{GS} = 0 V; I _D = 10 μA	20	-	-	V
V _{GS(TO)}	Gate threshold voltage	V _{DS} = V _{GS} ; I _D = 1 mA	0.4	0.57	-	V
		T _j = 150 °C	0.1	-	-	V
R _{DS(ON)}	Drain-source on-state resistance	V _{GS} = 4.5 V; I _D = 0.6 A	-	140	200	mΩ
		V _{GS} = 2.5 V; I _D = 0.6 A	-	180	250	mΩ
		V _{GS} = 1.8 V; I _D = 0.3 A	-	240	300	mΩ
		V _{GS} = 2.5 V; I _D = 0.6 A; T _j = 150 °C	-	270	375	mΩ
g _{fs}	Forward transconductance	V _{DS} = 16 V; I _D = 0.6 A	0.5	1.6	-	S
I _{GSS}	Gate source leakage current	V _{GS} = ±8 V; V _{DS} = 0 V	-	10	100	nA
I _{DSS}	Zero gate voltage drain current	V _{DS} = 16 V; V _{GS} = 0 V;	-	50	100	nA
		T _j = 150 °C	-	1.3	10	μA
Q _{g(tot)}	Total gate charge	I _D = 1 A; V _{DD} = 20 V; V _{GS} = 4.5 V	-	3.9	-	nC
Q _{gs}	Gate-source charge		-	0.4	-	nC
Q _{gd}	Gate-drain (Miller) charge		-	1.4	-	nC
t _{d on}	Turn-on delay time	V _{DD} = 20 V; I _D = 1 A;	-	2	-	ns
t _r	Turn-on rise time	V _{GS} = 8 V; R _G = 6 Ω	-	4.5	-	ns
t _{d off}	Turn-off delay time	Resistive load	-	45	-	ns
t _f	Turn-off fall time		-	20	-	ns
C _{iss}	Input capacitance	V _{GS} = 0 V; V _{DS} = 16 V; f = 1 MHz	-	152	-	pF
C _{oss}	Output capacitance		-	71	-	pF
C _{rss}	Feedback capacitance		-	33	-	pF

REVERSE DIODE LIMITING VALUES AND CHARACTERISTICS

T_j = 25 °C unless otherwise specified

SYMBOL	PARAMETER	CONDITIONS	MIN.	TYP.	MAX.	UNIT
I _{DR}	Continuous reverse drain current	T _a = 25 °C	-	-	1.05	A
I _{DRM}	Pulsed reverse drain current		-	-	4.2	A
V _{SD}	Diode forward voltage	I _F = 0.5 A; V _{GS} = 0 V	-	0.74	1	V
t _{rr}	Reverse recovery time	I _F = 0.5 A; -di _F /dt = 100 A/μs;	-	27	-	ns
Q _{rr}	Reverse recovery charge	V _{GS} = 0 V; V _R = 16 V	-	19	-	nC

N-channel enhancement mode
MOS transistor

BSH105

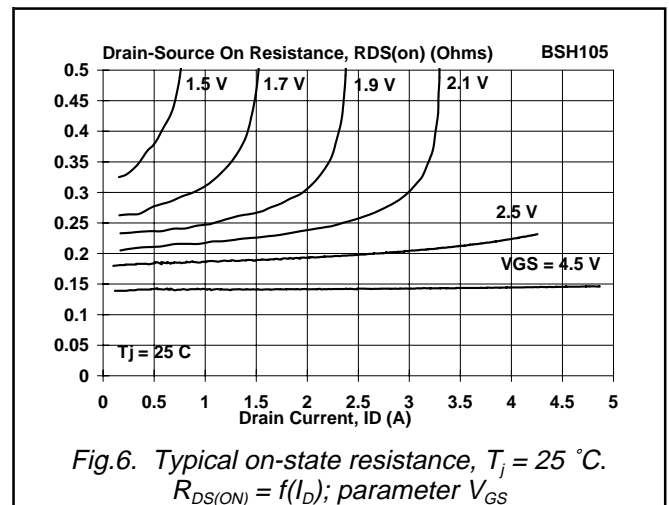
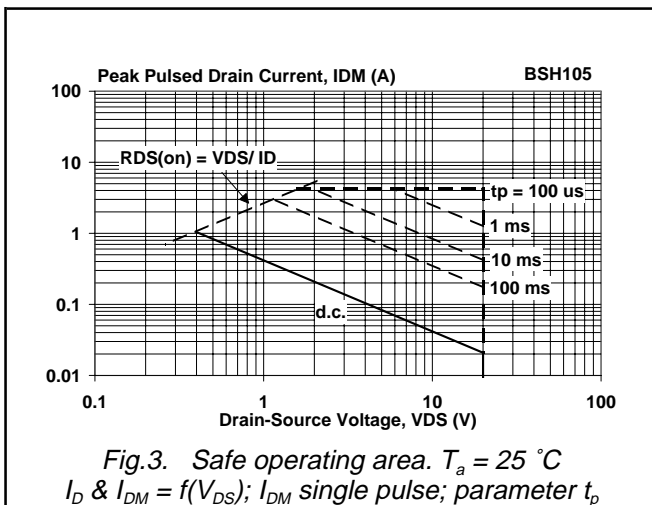
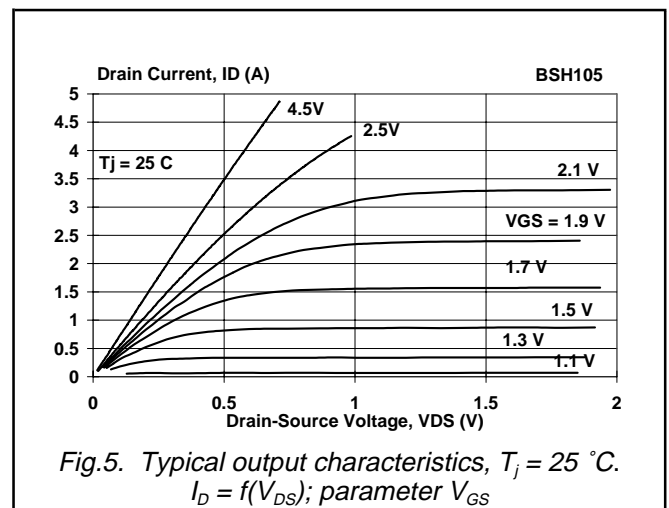
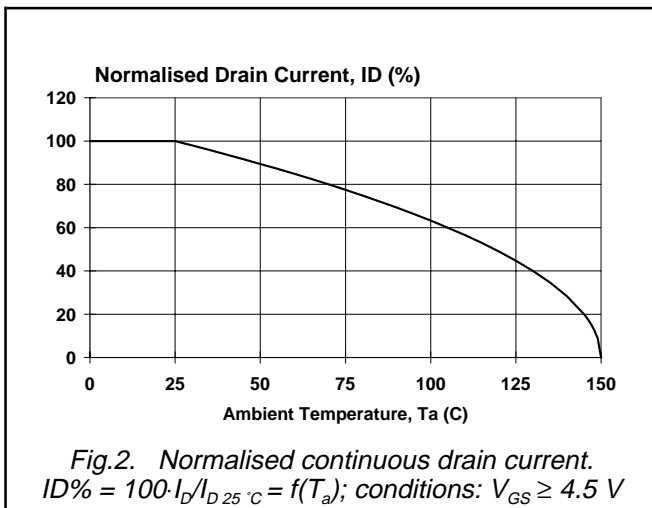
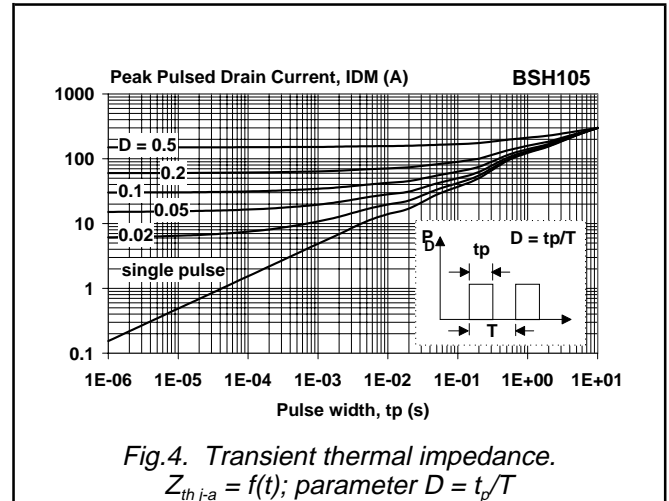

N-channel enhancement mode MOS transistor

BSH105

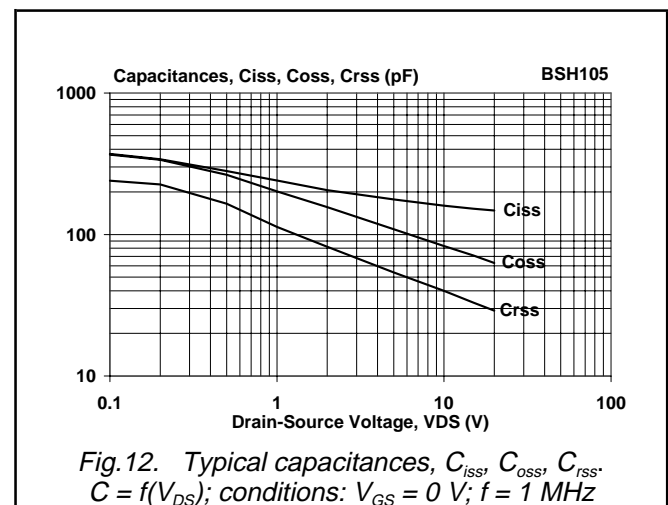
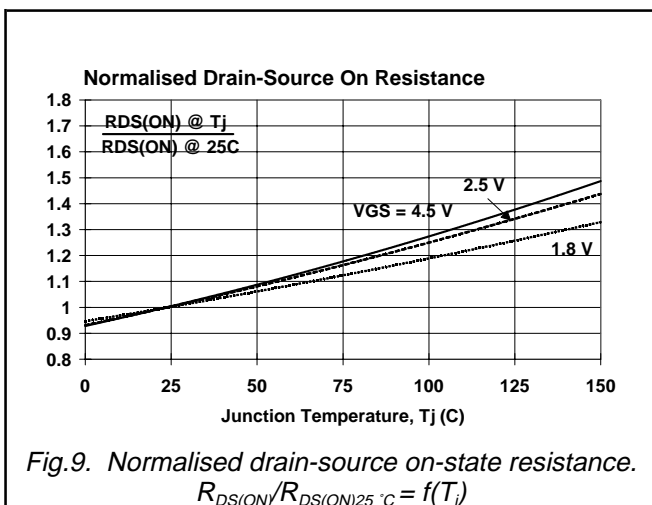
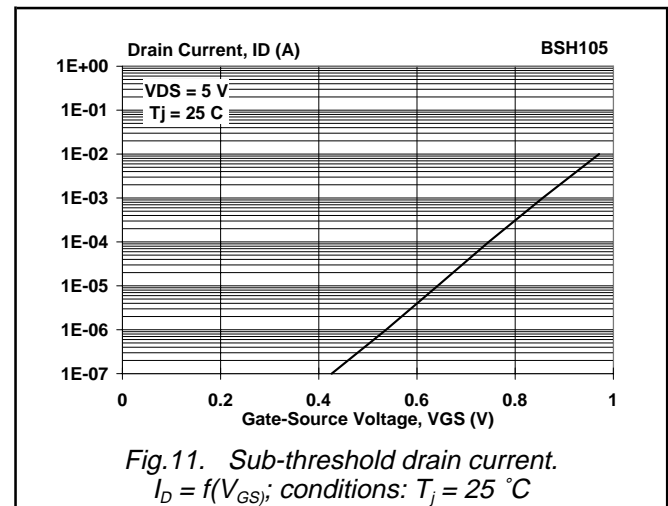
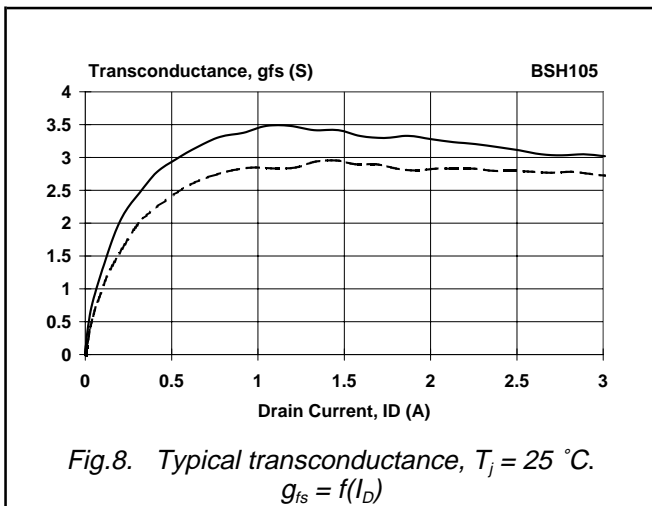
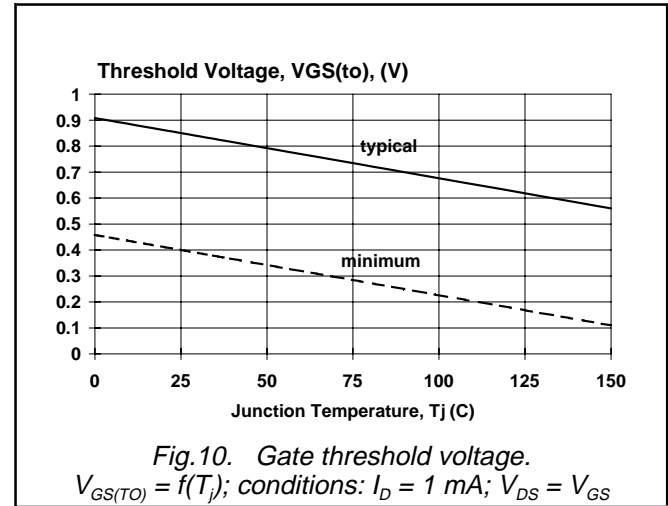
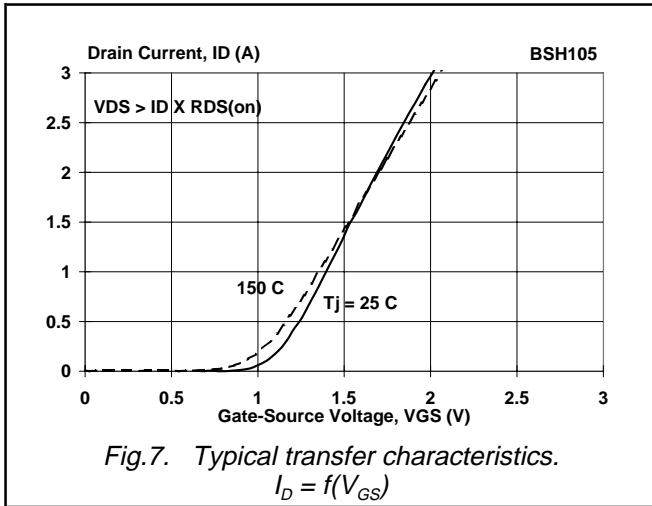

N-channel enhancement mode
MOS transistor

BSH105

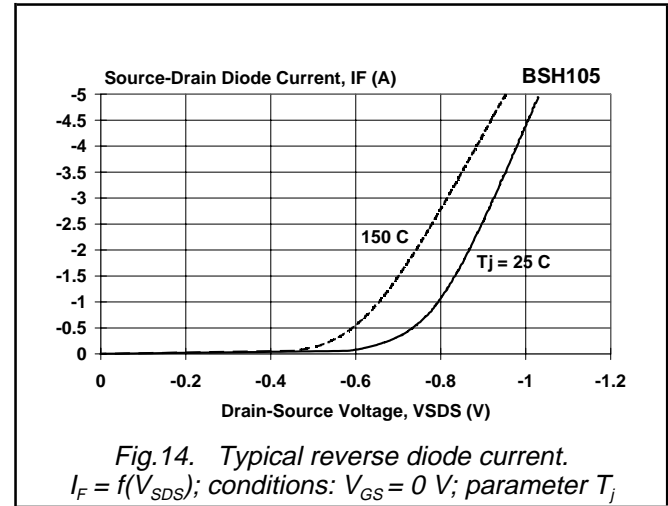
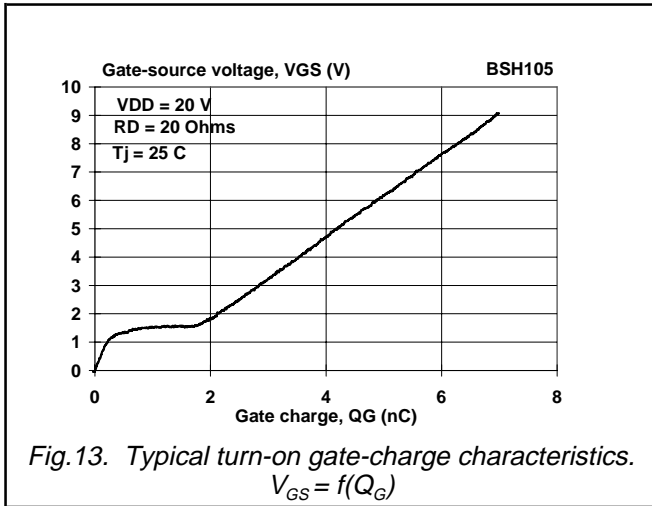

N-channel enhancement mode
MOS transistor

BSH105

MECHANICAL DATA



Fig.15. SOT23 surface mounting package.

Notes

1. This product is supplied in anti-static packaging. The gate-source input must be protected against static discharge during transport or handling.
2. Refer to SMD Footprint Design and Soldering Guidelines, Data Handbook SC18.
3. Epoxy meets UL94 V0 at 1/8".

N-channel enhancement mode MOS transistor

BSH105

DEFINITIONS

Data sheet status	
Objective specification	This data sheet contains target or goal specifications for product development.
Preliminary specification	This data sheet contains preliminary data; supplementary data may be published later.
Product specification	This data sheet contains final product specifications.
Limiting values	
Limiting values are given in accordance with the Absolute Maximum Rating System (IEC 134). Stress above one or more of the limiting values may cause permanent damage to the device. These are stress ratings only and operation of the device at these or at any other conditions above those given in the Characteristics sections of this specification is not implied. Exposure to limiting values for extended periods may affect device reliability.	
Application information	
Where application information is given, it is advisory and does not form part of the specification.	
© Philips Electronics N.V. 1998	
All rights are reserved. Reproduction in whole or in part is prohibited without the prior written consent of the copyright owner.	
The information presented in this document does not form part of any quotation or contract, it is believed to be accurate and reliable and may be changed without notice. No liability will be accepted by the publisher for any consequence of its use. Publication thereof does not convey nor imply any license under patent or other industrial or intellectual property rights.	

LIFE SUPPORT APPLICATIONS

These products are not designed for use in life support appliances, devices or systems where malfunction of these products can be reasonably expected to result in personal injury. Philips customers using or selling these products for use in such applications do so at their own risk and agree to fully indemnify Philips for any damages resulting from such improper use or sale.

BSH105; N-channel enhancement mode MOS transistor

Information as of 2003-01-21

My.Semiconductors.COM.
Your personal service from Philips Semiconductors.
Please register now !

Use right mouse button to download datasheet

Download datasheet

Stay informed

Products

- MultiMarket Semiconductors
- ASICs
- Product Selector
- Catalog by Function
- Catalog by System
- Cross-reference
- Packages
- End of Life information
- Distributors Go Here!

General description	Features	Applications	Datasheet
Block diagram	Buy online	Support & tools	Email/translate
Products & packages	Parametrics	Similar products	

General description

N-channel, enhancement mode, logic level, field-effect power transistor. This device has very low threshold voltage and extremely fast switching making it ideal for battery powered applications and high speed digital interfacing.

The BSH105 is supplied in the SOT23 subminiature surface mounting package.

Features

- Very low threshold voltage
- Fast switching
- Logic level compatible
- Subminiature surface mount package

Datasheet

Type number	Title	Publication release date	Datasheet status	Page count	File size (kB)	Datasheet
BSH105	N-channel enhancement mode MOS transistor	01-Aug-98	Product specification	7	110	 Download

Parametrics

Type number	Package	V _{DS} (V)	Configuration	I _D DC(A)	R _{DS(on)} (mOhm)	Q _{gd} (typ)(nC)
BSH105	SOT23 (SST3)	20	Single N-channel	1.05	200@4.5V 250@2.5V	1.4

❑ Products, packages, availability and ordering

<u>Type number</u>	<u>North American type number</u>	<u>Ordering code (12NC)</u>	<u>Marking/Packing</u> Discretes packing info	<u>Package</u>	<u>Device status</u>	<u>Buy online</u>
BSH105	BSH105 T/R	9340 547 15215	Standard Marking * Reel Pack, SMD, Low Profile	SOT23 (SST3)	Full production	-
	BSH105 /T3	9340 547 15235	Standard Marking * Reel Pack, SMD, Low Profile, Large	SOT23 (SST3)	Full production	-

❑ Similar products

[BSH105](#) links to the similar products page containing an overview of products that are similar in function or related to the type number(s) as listed on this page. The similar products page includes products from the same catalog tree(s), relevant selection guides and products from the same functional category.

❑ Email/translate this product information

- [Email this product information.](#)
- Translate this product information page from English to:

The English language is the official language used at the [semiconductors.philips.com](#) website and webpages. All translations on this website are created through the use of [Google Language Tools](#) and are provided for convenience purposes only. No rights can be derived from any translation on this website.

[About this Web Site](#)

| Copyright © 2003 Koninklijke Philips N.V. All rights reserved. | [Privacy Policy](#) |

| Koninklijke Philips N.V. | Access to and use of this Web Site is subject to the following [Terms of Use](#). |