

EEPROM & RAM

I²C Serial EEPROM and RAM

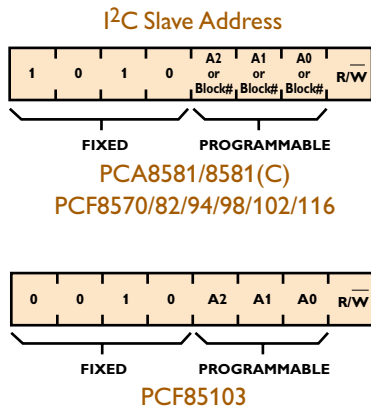

Description

The Philips family of I²C bus compatible memories comprises RAM, EEPROM, video memories and Flash memories.

Small size serial memories (RAM and EEPROM) are fairly common and widely used in many different applications. EEPROM is particularly useful in applications where data retention during power-off is essential. Such applications include but are not limited to: meter readings, electronic key, product identification number, serial presence detect (SPD) on DIMMs, etc. A common pinning is used for these serial memories because their functionality is very similar. The common pinout was selected to allow interchangeability. EEPROMs store data (2 Kbits organized in 256 X 8 in the PCF8582C-2 for example), including set points, temperature, alarms, DIMM information and more, for a guaranteed minimum storage time of ten years in the absence of power. EEPROMs can change values up to 1,000,000 times and have an infinite number of read cycles, while consuming only 10 micro Amperes of current.

RAM—Random Access Memory

- The PCF8570 is organized as 256 words of 8-bytes.

EEPROM—EEPROM is Electrically Erasable Programmable Read Only Memory

- The PCF8581/8581C is organized as 128 words of 8-bytes.
- The PCF8582C-2 is organized as 256 words of 8-bytes.
- The PCF8594C-2 is organized as 512 words of 8-bytes in two 256 word pages.
- The PCF8598C-2 is organized as 1024 words of 8-bytes in four 256 word pages.
- The PCF85116-3 is organized as 2048 words of 8-bytes in eight 256 word pages.

The PCF8582C-2 is pin and address compatible with the PCF8570 and PCA8581. The PCF85102C-2 is identical to the PCF8582C-2, with pin 7 (Programming Time Control output) as a no connect, to allow it to be used in competitors' sockets, since PTC should be left floating or held at V_{CC}. The PCF85103C-2 is identical to the PCF8582C-2 except that the fixed I²C address is different, allowing up to eight of each device to be used on the same I²C bus.

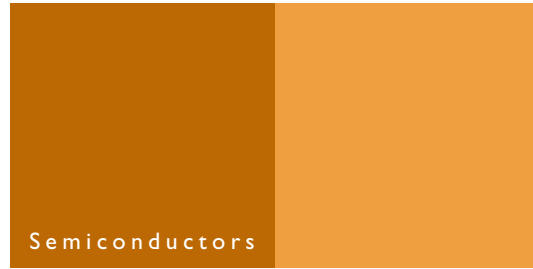

Addresses and data are transferred serially via a two-wire bi-directional bus (I²C-bus). The built-in word address register is incremented automatically after each written or read data byte. All bytes can be read in a single operation. Up to 8 bytes can be written in one operation, reducing the total write time per byte.

The 512-byte, 1024-byte and 2048-byte EEPROMs use the programmable address (Ax or Block #) to either select the slave address or one of the 256 word pages (e.g., the PCF8594C-2 has two addressable pages with up to four devices allowed on the same I²C bus while the PCF85116-3 has eight addressable pages but only one device is allowed on the same I²C bus).

EEPROM/RAM Features

- Wide voltage range of 2.5V to 5.5V
- Internal non-volatile registers (except PCF8570) with a minimum of 1,000,000 write cycles at Tambient = 22 °C
- Infinite number of read cycles
- 10 year data retention (Minimum)
- Low power CMOS devices
- Non volatile storage from 128x8-bit to 2048x8-bit
- Write operation per byte or per 8-byte page
- Read operation can be sequential or random
- Internal timer for writing operation (no external components required)
- Internal Power On Reset
- High reliability by using redundant EEPROMS cells
- Offered in 8-pin DIP (N) and SO (D) packages

Key Points

- The I²C bus is used to read and write information to and from the memory
- A wide voltage range minimizes the number of EEPROMs that need to be stocked

PHILIPS

EEPROM & RAM

I²C Serial EEPROM and RAM



EEPROM/RAM Operating Characteristics

	PCA8581 PCA8581C	PCF8582C-2 PCF85102C-2 PCF85103C-2	PCF8594C-2	PCF8598C-2	PCF85116-3	PCF8570
Power Supply	4.5 to 5.5 V 2.5 to 6 V	2.5 to 6 V	2.5 to 6 V	2.5 to 6 V	2.7 to 5.5 V	2.5 to 6 V
Address pins	3	3	2	1	0	3
Nb of block (256 bytes)	0.5	1	2	4	8	1
Data retention time	10 years	10 years	10 years	10 years	20 years	N/A
Temperature range	-25 to +85°C	-40 to +85°C	-40 to +85°C	-40 to +85°C	-40 to +85°C	-40 to +85°C
Clock frequency	100 kHz	100 kHz	100 kHz	100 kHz	400 kHz	100 kHz

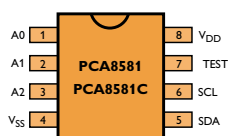

128 x 8-bit (1K) EEPROM

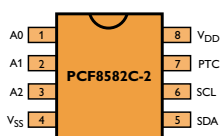

256 x 8-bit (2K) EEPROM

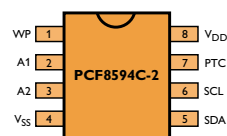

512 x 8-bit (4K) EEPROM

The PCF85102C-2 is identical to the PCF8582C-2 except that the Programming Time Control (PTC) output is not connected to allow alternate sourcing of other manufacturer's devices.

The PCF85103C-2 is identical to the PCF8582C-2 except it has a different fixed I²C address allowing up to 8 of each device on the same I²C bus.

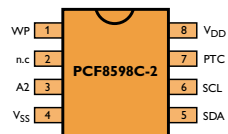

1024 x 8-bit (8K) EEPROM

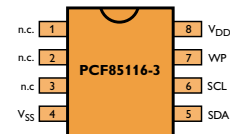

2048 x 8-bit (16K) EEPROM

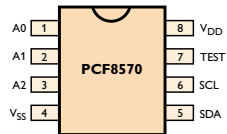

256 x 8-bit (2K) RAM

Ordering Information

Package	Container	PCA8581(C)	PCF8582C-2	PCF8594C-2	PCF8598C-2	PCF85102C-2	PCF85103C-2	PCF85116-3	PCF8570
DIP	Tube	PCA8581PN	PCF8582C2N	PCF8594C2N	PCF8598C2N	PCF85102C2N	PCF85103C2N	PCF85116-3N	PCF8570PN
SO	Tube	PCA8581(C)TD	PCF8582C2D	PCF8594C2D	PCF8598C2D	PCF85102C2D	PCF85103C2D	PCF85116-3D	PCF8570TD
	T&R	PCA8581(C)TD-T	PCF8582C2D-T	PCF8594C2D-T	PCF8598C2D-T	PCF85102C2D-T	PCF85103C2D-T	PCF85116-3D-T	PCF8570TD-T



Purchase of Philips I²C components conveys a license under the Philips' patent to use the components in the I²C system provided the system conforms to the I²C specification defined by Philips.

www.semiconductors.philips.com/logic/i2c



Philips Semiconductors

Philips Semiconductors is a worldwide company with over 100 sales offices in more than 50 countries. For a complete up-to-date list of our sales offices please e-mail sales.addresses@www.semiconductors.philips.com.

A complete list will be sent to you automatically. You can also visit our website <http://www.semiconductors.philips.com/sales>

© Koninklijke Philips Electronics N.V. 2002

All rights reserved. Reproduction in whole or in part is prohibited without the prior written consent of the copyright owner. The information presented in this document does not form part of any quotation or contract, is believed to be accurate and reliable and may be changed without notice. No liability will be accepted by the publisher for any consequence of its use. Publication thereof does not convey nor imply any license under patent- or other industrial or intellectual property rights.

Date of release: November 2002
document order number: 9397 750 10658

Published in U.S.A.