

# Precision Devices, Inc.

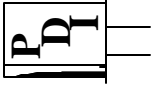

8840 N. Greenview Dr.  
 Middleton, WI 53562  
 Phone: 608-831-4445  
 1-800-274-XTAL  
 Fax: 608-831-3343

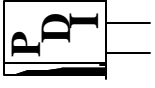

Visit our web site at [www.pdixtal.com](http://www.pdixtal.com)

Sales Information [sales@pdixtal.com](mailto:sales@pdixtal.com)

## Electrical Specifications

1. Center Frequency: 32.76800 kHz
2. Oscillation Mode: Fundamental
3. Max. Series Resistance: 40K Ohms
4. Tolerance @ 25°C: ±20ppm
5. Operating Temperature Range: -40°C to +85°C
6. Max. Change over Temp Range: ±30ppm
7. Drive Level: 10uW Max.
8. Seal Method: Plastic Molded
9. Co (Shunt Capacitance): 2.0pF Max.
10. C1 (Motional Capacitance): N/A
11. Cl (Load Capacitance): 12.5pF
12. Aging: ±5.0ppm/year Max.
13. Turnover Temperature @24°C: ±4.0°C
14. Parabolic Curvature Constant: 0.034±0.006ppm/°C
15. Reflow Conditions: 240°C ±5%, 10 seconds Max.

REV.	DATE	PAGE	DESCRIPTION	AUTH.	ECN	Originator	Date	Engineering	Date
						D.G.	1/27/10	M.B.	1/27/10
						TITLE Plastic SMD Crystal Assy Tape/Reel		FKA 11147	
						PART NUMBER <b>P800032XFS12XA</b>			
						DATE 1/27/10	SCALE N.T.S.	ECN. E0903	REV. B
B	1/10	1	Removed Note: Tape/Reel optional from spec.	J.L.	E0903	SIZE A	CAGE 0S4G1		Page 1 of 2

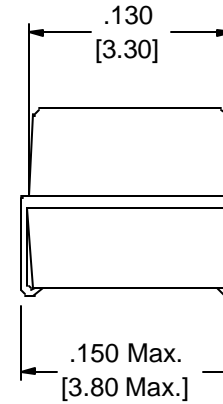
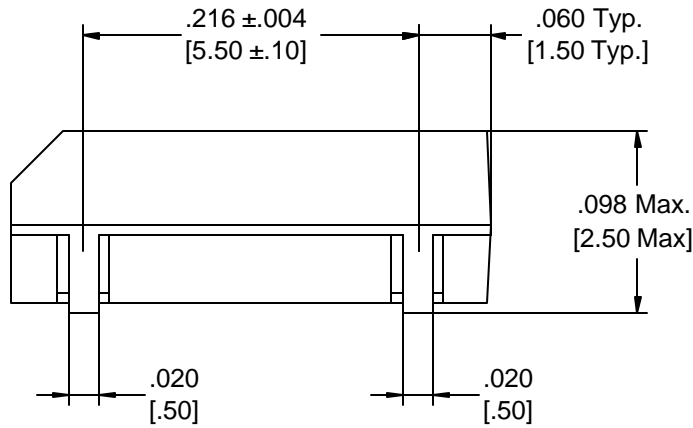
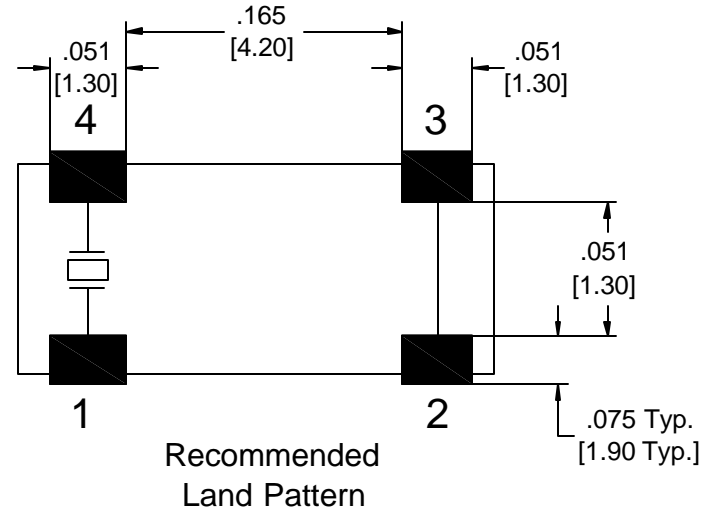
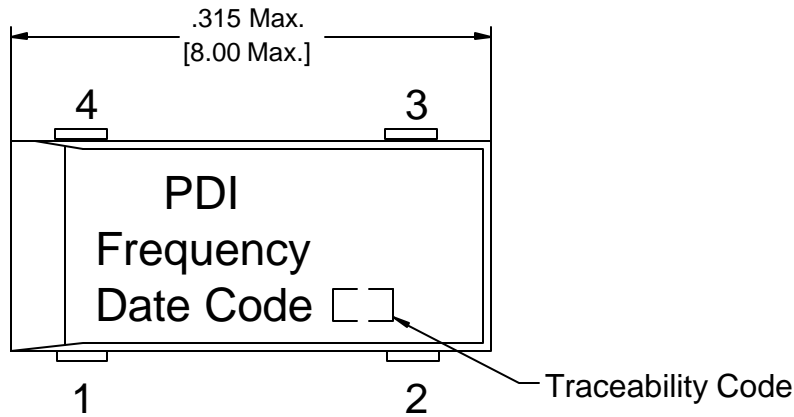

# Precision Devices Inc.

8840 N. Greenview Dr.  
Middleton WI 53562  
608-831-4445  
1-800-274-XTAL

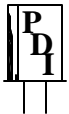

Manufacturer of Quartz Crystal Products

DECIMAL XX=±.020 XXX=±.008	DWG FILE <b>11147</b>	PART NUMBER <b>P800032XFSD12XA</b>	
METRIC XX=±.50 XXX=±.20	SCALE <b>N.T.S.</b>	FREQUENCY <b>32.76800 kHz</b>	DRAWN BY <b>D. Gibney</b>
ANGULAR XX=±2°	REV. LEVEL <b>B</b>	ECN NO. <b>E0903</b>	DATE <b>1/27/10</b>
		CAGE CODE <b>0S4G1</b>	<b>Page 2 of 2</b>
		Drawing Type: Plastic SMD Crystal Assembly	