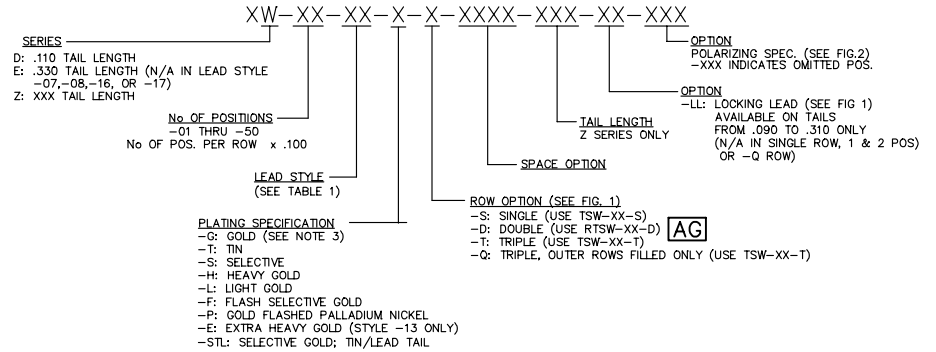

TABLE 1			
LEAD STYLE		TERMINAL	'L' OVERALL LENGTH (REF)
SERIES D&Z	SERIES E		
07	N/A	T-1S6-07-X-2	.430
08	N/A	T-1S6-08-X-2	.530
09	09	T-1S6-09-X-2	.730
10	10	T-1S6-10-X-2	.830
11	11	T-1S6-11-X-2	.930
12	12	T-1S6-12-X-2	1.030
13	13	T-1S6-13-X-2	1.230
14	14	T-1S6-14-X-2	1.430
15	15	T-1S6-15-X-2	.630
16	N/A	T-1S6-16-X-2	.445
17	N/A	T-1S6-17-X-2	.480
19	19	T-1S6-19-X-2	1.330
20	20	T-1S6-20-X-2	1.130

DIMENSIONS ARE IN INCHES		UNLESS OTHERWISE NOTED TOLERANCES ARE:		TITLE: LOW COST BOARD SPACERS	DWG NO: XW-XX-XX-X-X-XXXX-XXX-XX-XXX
ONE PLACE DECIMALS ±.1	THREE PLACE DECIMALS ±.005	ANGLES ± 2°	FOUR PLACE DECIMALS ±.0020		SHEET 1 OF 2
TWO PLACE DECIMALS ±.01					



DO NOT SCALE FROM THIS PRINT

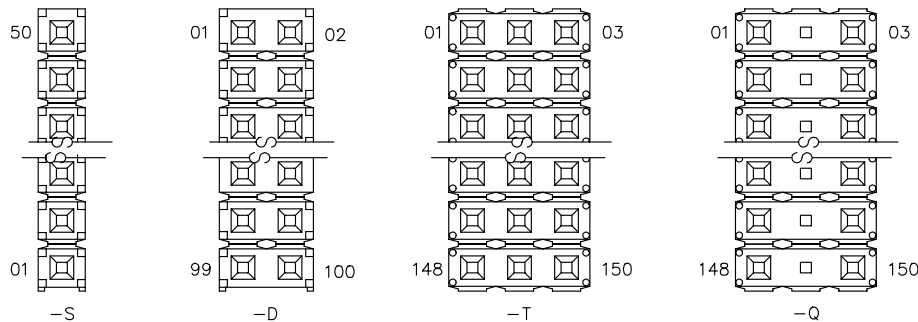
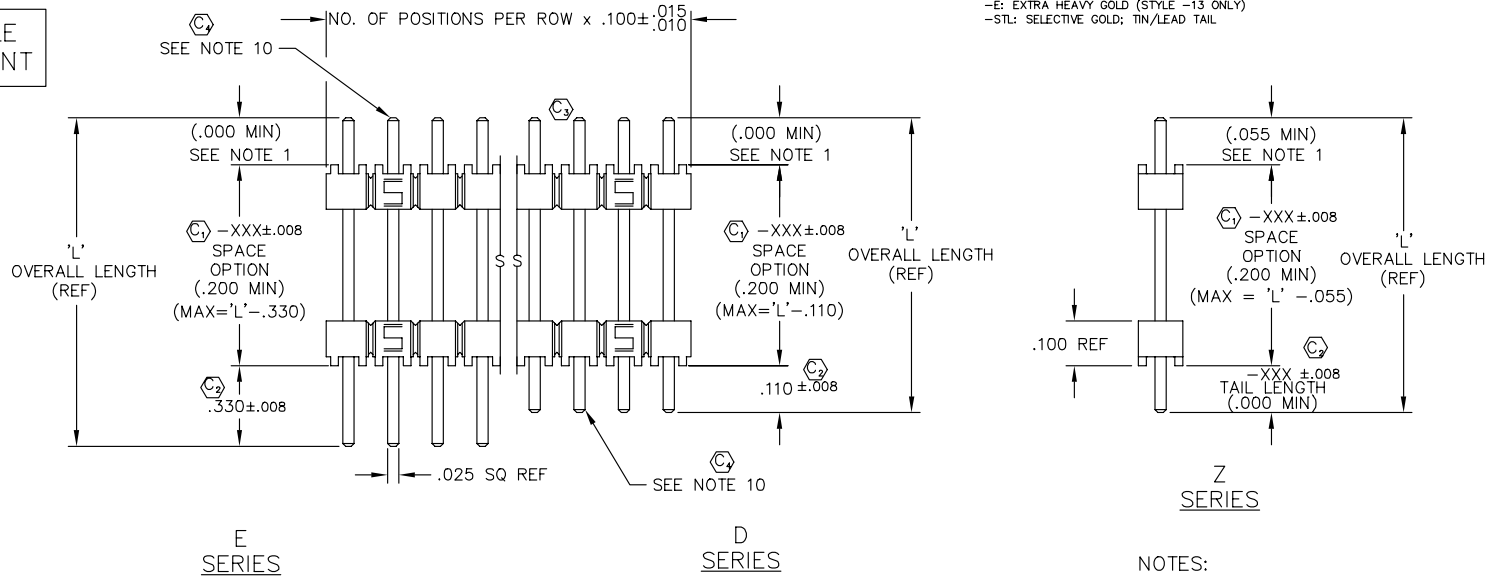

FIGURE 2

NUMBER POSITIONS WITH .330, .110, OR ZW TAIL DOWN

NOTES:

1. HEIGHT VARIATION BETWEEN ANY TWO PINS SHALL BE .010 MAX.
2. ~~DELETED~~ -S PLATING: PLATED AREA WILL BE ON THE LONGER TAIL.
3. ~~DELETED~~ -G PLATING: HEAVY GOLD ON LONGER TAIL
4. ~~DELETED~~ -L PLATING: GOLD ON LONGER TAIL
5. ~~DELETED~~ -H PLATING: HEAVY GOLD ON LONGER TAIL
6. ~~DELETED~~ -F PLATING: FLASH SELECTIVE GOLD ON LONGER TAIL
7. ~~DELETED~~ -P PLATING: GOLD FLASHED PALLADIUM NICKEL ON LONGER TAIL
8. ~~DELETED~~ -E PLATING: EXTRA HEAVY GOLD ON LONGER TAIL
9. (⊙) REPRESENTS A CRITICAL DIMENSION.
10. -F, -S, -L, -P GOLD TO BE ON LONGER TAIL.
-G, -H, -E, HEAVY GOLD TO BE ON LONGER TAIL.
11. CRIMPED TAILS OF .090 TO BE TOLERANCED +.008/-.000.
12. TSW-50-D TO BE USED IF RTSW-50-D IS NOT AVAILABLE

PROPRIETARY NOTE
 THIS DOCUMENT CONTAINS INFORMATION CONFIDENTIAL AND PROPRIETARY TO SAMTEC INC AND SHALL NOT BE REPRODUCED OR TRANSFERRED TO OTHER DOCUMENTS OR DISCLOSED TO OTHERS OR USED FOR ANY PURPOSE OTHER THAN THAT FOR WHICH IT WAS OBTAINED WITHOUT THE EXPRESSED WRITTEN CONSENT OF SAMTEC INC.

MATERIAL:
 BODIES:
 SINGLE & DOUBLE ROW STRAIGHT:
 VALOX DR-48 or
 DUPONT CRASTIN SK652FR
 ALL OTHER BODY STYLES:
 VALOX 420 SEC
 GLASS FILLED POLYESTER
 COLOR:BLACK
 TERMINALS:
 PHOSPHOR BRONZE, ALLOY
 NO. 510, 3/4 HARD,
 TENSILE RANGE 95-105 KSI



EXISPROD\ASSEMBLY\100 XW-ASM
 520 PARK EAST BLVD. NEW ALBANY, INDIANA 47150
 PHONE (812) 944-6733 P.O. BOX 1147
 CODE 55322

MADE BY: WILLIAMS 8-13-84

DIMENSIONS ARE IN INCHES		UNLESS OTHERWISE NOTED	TOLERANCES ARE:
ONE PLACE DECIMALS ±.1	THREE PLACE DECIMALS ± .005	ANGLES ± 2°	
TWO PLACE DECIMALS ±.01	FOUR PLACE DECIMALS ± .0020		

TITLE:
LOW COST BOARD SPACERS

DWG NO:
XW-XX-XX-X-X-XXXX-XXX-XX-XXX
SHEET 2 OF 2

CRIMP SHORTER TAIL
(OPPOSITE GOLD CONTACT AREA)

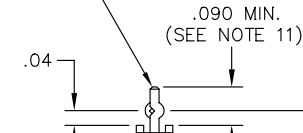

SEE CRIMP DETAIL

RTSW-XX-D

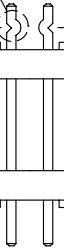

TSW-50-T

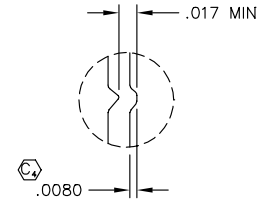
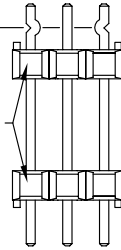

CRIMP DETAIL
SCALE: 2x
[TYP- ALL CRIMPS]

-S

-D

-I

FIG. 1
LOCKING LEAD OPTION

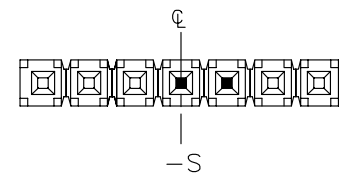
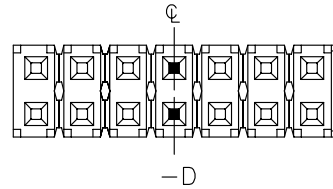
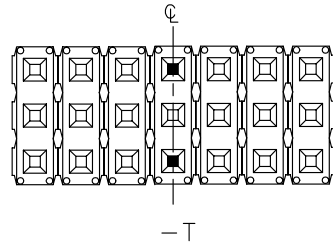

■ = CRIMP LOCATION
ODD POSITIONS

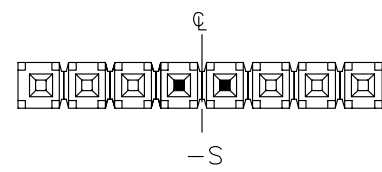
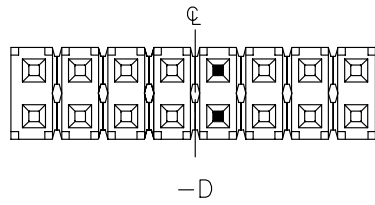
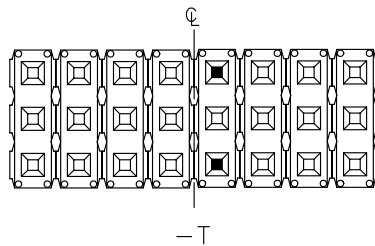

■ = CRIMP LOCATION
EVEN POSITIONS

PROPRIETARY NOTE
THIS DOCUMENT CONTAINS INFORMATION CONFIDENTIAL AND PROPRIETARY TO SAMTEC INC. AND SHALL NOT BE REPRODUCED OR TRANSFERRED TO OTHER DOCUMENTS OR DISCLOSED TO OTHERS OR USED FOR ANY PURPOSE OTHER THAN THAT FOR WHICH IT WAS OBTAINED WITHOUT THE EXPRESSED WRITTEN CONSENT OF SAMTEC INC.

 EXISPROD\ASSEMBLY\100 XW-ASM2	
520 PARK EAST BLVD. NEW ALBANY, INDIANA 47150 PHONE (812) 944-6733 P.O. BOX 1147 CODE 55322	
MADE BY: WILLIAMS 8-13-84	XW-XX-XX-X-X-XXXX-XXX-XX-XXX SHEET 2 OF 2