

## Automotive dual Transil™ array for ESD protection

### Features

- Dual unidirectional Transil functions
- Low leakage current:  $I_R$  max. < 20  $\mu$ A at  $V_{BR}$
- 300 W peak pulse power (8/20  $\mu$ s)

### Benefits

- High ESD protection level: up to 25 kV
- High integration
- Suitable for high density boards
- AEC-Q101 qualified

### Complies with the following standards

- ISO 10605: C = 150 pF, R = 330  $\Omega$ 
  - 30 kV (air discharge)
  - 30 kV (contact discharge)
- ISO 10605: C = 330 pF, R = 330  $\Omega$ 
  - 30 kV (air discharge)
  - 30 kV (contact discharge)
- ISO 7637-2<sup>(a)</sup>
  - Pulse 1:  $V_S = -100$  V
  - Pulse 2a:  $V_S = +50$  V
  - Pulse 3a:  $V_S = -150$  V
  - Pulse 3b:  $V_S = +100$  V

### Applications

Where transient overvoltage protection in ESD sensitive equipment is required, such as:

- Entertainment
- Signal communications
- Connectivity
- Comfort and convenience

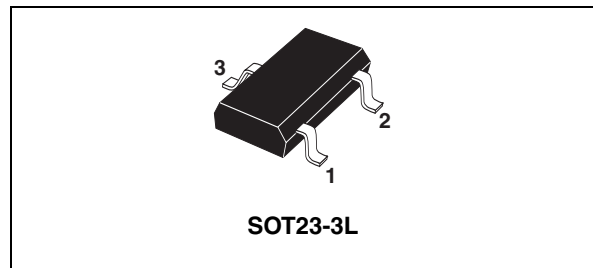
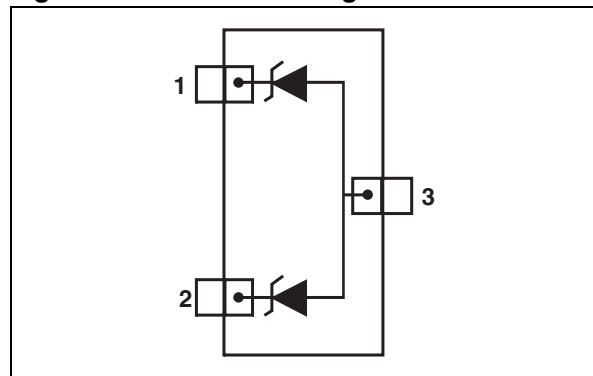

Figure 1. Functional diagram



### Description

The ESDALY is a monolithic array designed to protect 1 line or 2 lines against ESD transients. The device is ideal for applications where both reduced line capacitance and board space saving are required. It can also be used as bidirectional suppressor by connecting only pin 1 and 2.

a. Not applicable to parts with stand-off voltage lower than the average battery voltage (13.5 V)

TM: Transil is a trademark of STMicroelectronics.

# 1 Characteristics

**Table 1. Absolute maximum ratings ( $T_{amb} = 25\text{ }^{\circ}\text{C}$ )**

| Symbol    | Parameter  | Value   | Unit               |    |
|-----------|--|---|--------------------|----|
| $V_{PP}$  | Peak pulse voltage <sup>(1)</sup>                                    | ISO 10605 (C = 330 pF, R = 330 $\Omega$ ):<br>contact discharge | 30                 | kV |
|           |  | air discharge   | 30                 |    |
|           |  | ISO 10605: C = 150 pF, R = 330 $\Omega$<br>contact discharge    | 30                 |    |
|           |  | air discharge   | 30                 |    |
| $P_{PP}$  | Peak pulse power (8/20 $\mu$ s)                                      | 300   | W                  |    |
| $I_{PP}$  | Peak pulse current (8/20 $\mu$ s)                                    | ESDA5V3LY   | 25                 | A  |
|           |  | ESDA6V1LY   | 18                 |    |
|           |  | ESDA14V2LY  | 14                 |    |
|           |  | ESDA25LY  | 7                  |    |
| $T_j$     | Operating junction temperature range                                 | -40 to 150  | $^{\circ}\text{C}$ |    |
| $T_{stg}$ | Storage temperature range  | -65 to +150   | $^{\circ}\text{C}$ |    |
| $T_L$     | Maximum lead temperature for soldering during 10 s at 5 mm from case | 260   | $^{\circ}\text{C}$ |    |

1. For a surge greater than the maximum values, the diode will fail in short-circuit.

**Figure 2. Electrical characteristics (definitions)**

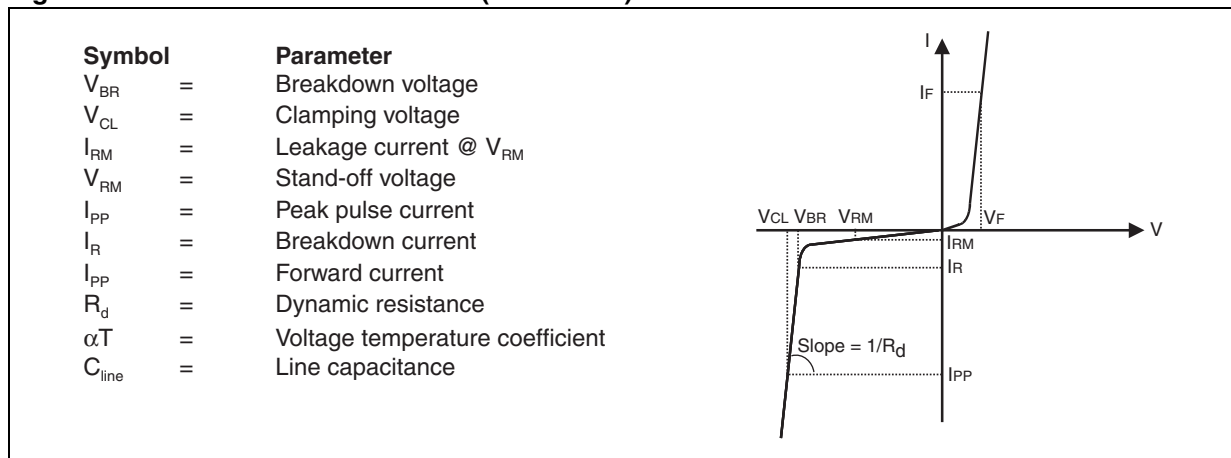

Table 2. Electrical characteristics (values,  $T_{amb} = 25\text{ }^{\circ}\text{C}$ )

| Order code | $V_{BR} @ I_R$ |      |    | $I_{RM} @ V_{RM}$ |     | $V_{CL} @ I_{PP}^{(1)}$ |    | $V_F @ I_F$ |     | $R_d^{(2)}$      | $\alpha T^{(3)}$           | $C_{line}$ |
|------------|----------------|------|----|-------------------|-----|-------------------------|----|-------------|-----|------------------|----------------------------|------------|
|            | Min.           | Max. |    | Max.              |     | Max.                    |    | Max.        |     | Typ.             | Max.                       | Typ.       |
|            | V              | V    | mA | $\mu\text{A}$     | V   | V                       | A  | V           | mA  | $\text{m}\Omega$ | $10^{-4}/^{\circ}\text{C}$ | pF         |
| ESDA5V3LY  | 5.3            | 5.9  | 1  | 2                 | 3   | 19                      | 25 | 1.25        | 200 | 280              | 5                          | 220        |
| ESDA6V1LY  | 6.1            | 7.2  | 1  | 20                | 5.2 | 16                      | 18 | 1.25        | 200 | 350              | 6                          | 140        |
| ESDA14V2LY | 14.2           | 15.8 | 1  | 5                 | 12  | 21                      | 14 | 1.25        | 200 | 650              | 10                         | 90         |
| ESDA25LY   | 25             | 30   | 1  | 1                 | 24  | 43                      | 7  | 1.2         | 10  | 1000             | 10                         | 50         |

- 8/20  $\mu\text{s}$  waveform
- Square pulse,  $I_{pp} = 15\text{ A}$ ,  $t_p = 2.5\text{ }\mu\text{s}$ .
- $\Delta V_{BR} = \alpha T * (T_{amb} - 25\text{ }^{\circ}\text{C}) * V_{BR}(25\text{ }^{\circ}\text{C})$

Figure 3. Variation of peak pulse power versus initial junction temperature

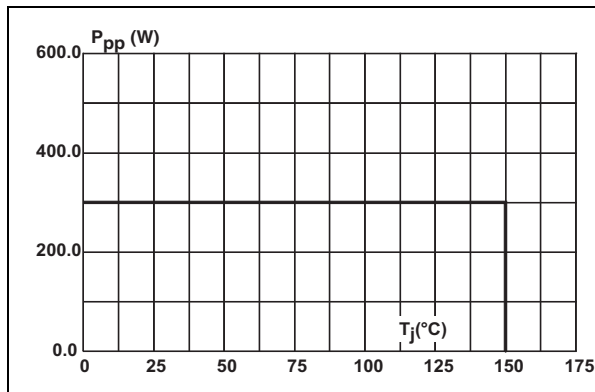

Figure 4. Peak pulse power versus exponential pulse duration (typical values)

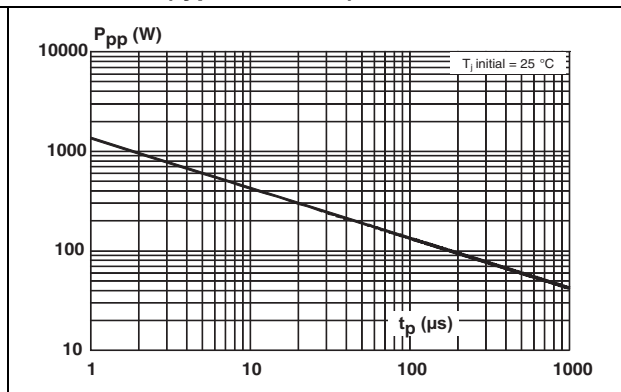

Figure 5. Variation of clamping voltage versus peak pulse current (max. values, 8/20  $\mu\text{s}$  waveform)

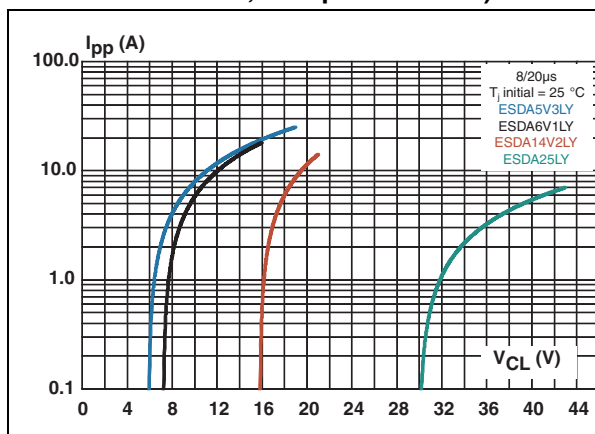

Figure 6. Relative variation of leakage current versus junction temperature (typical values)

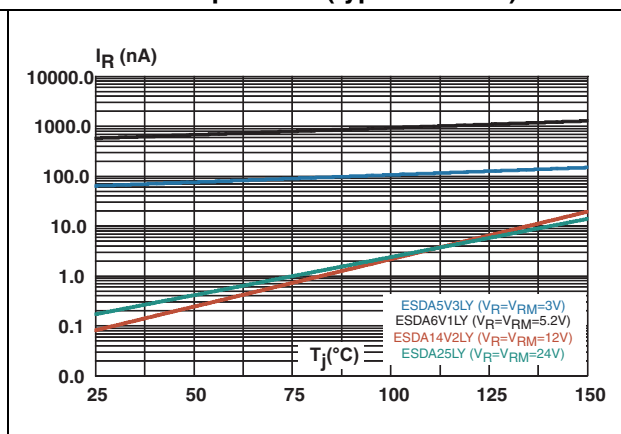

Figure 7. ISO 7637-2 pulse 1 response ( $V_S = -100\text{ V}$ )

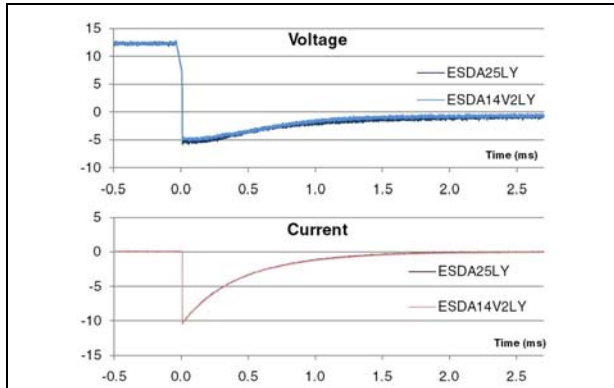

Figure 8. ISO 7637-2 pulse 2a response ( $V_S = 50\text{ V}$ )

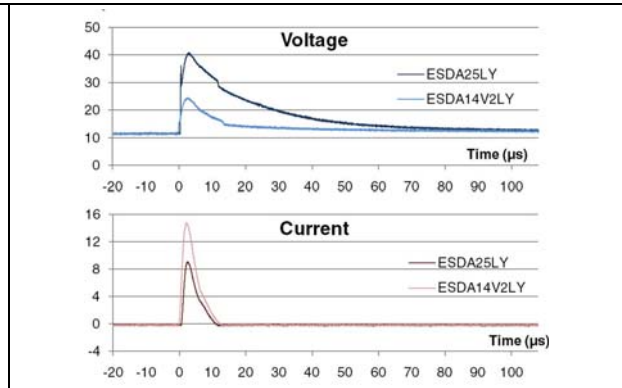

Figure 9. ISO 7637-2 pulse 3a response ( $V_S = -150\text{ V}$ )

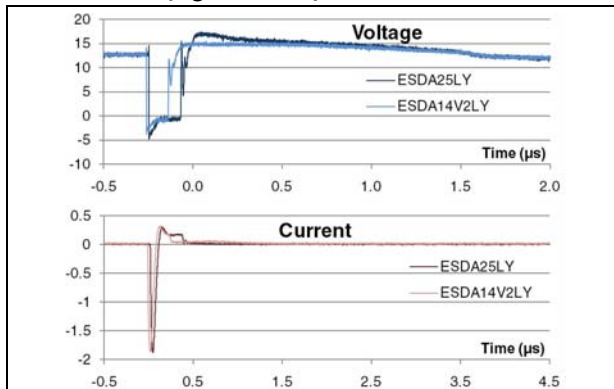
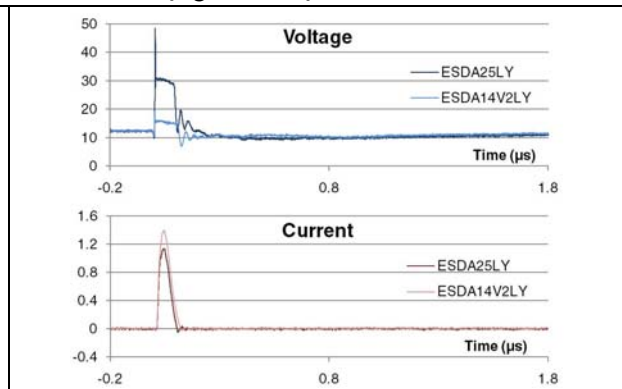

Figure 10. ISO 7637-2 pulse 3b response ( $V_S = 100\text{ V}$ )



Note: ISO7637-2 pulse responses are not applicable for products with a breakdown voltage lower than the average battery voltage (13.5 V) like ESDA5V3LY and ESDA6V1LY.

## 2 Application and design guidelines

More information is available in the application note:

AN2689, "Protection of automotive electronics from electrical hazards, guidelines for design and component selection".

## 3 Ordering information scheme

Figure 11. Ordering information scheme

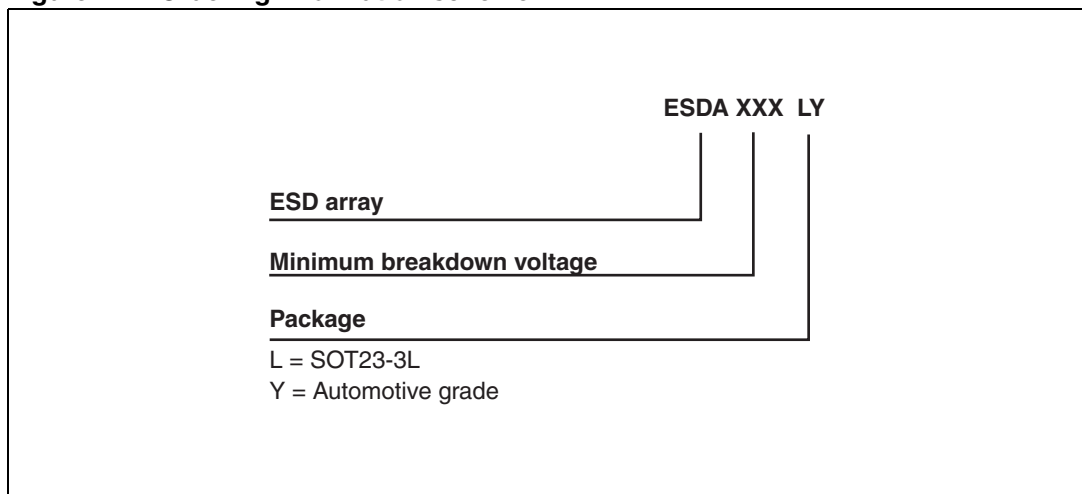

## 4 Package information

- Epoxy meets UL94, V0
- Lead-free package

In order to meet environmental requirements, ST offers these devices in different grades of ECOPACK® packages, depending on their level of environmental compliance. ECOPACK® specifications, grade definitions and product status are available at: [www.st.com](http://www.st.com). ECOPACK® is an ST trademark.

**Table 3. SOT23-3L dimensions**

| Ref. | Dimensions  |      |            |       |
|------|-------------|------|------------|-------|
|      | Millimeters |      | Inches     |       |
|      | Min.        | Max. | Min.       | Max.  |
| A    | 0.89        | 1.4  | 0.035      | 0.055 |
| A1   | 0           | 0.1  | 0          | 0.004 |
| B    | 0.3         | 0.51 | 0.012      | 0.02  |
| c    | 0.085       | 0.18 | 0.003      | 0.007 |
| D    | 2.75        | 3.04 | 0.108      | 0.12  |
| e    | 0.85        | 1.05 | 0.033      | 0.041 |
| e1   | 1.7         | 2.1  | 0.067      | 0.083 |
| E    | 1.2         | 1.6  | 0.047      | 0.063 |
| H    | 2.1         | 2.75 | 0.083      | 0.108 |
| L    | 0.6 typ.    |      | 0.024 typ. |       |
| S    | 0.35        | 0.65 | 0.014      | 0.026 |

**Figure 12. Footprint (dimensions in mm)**

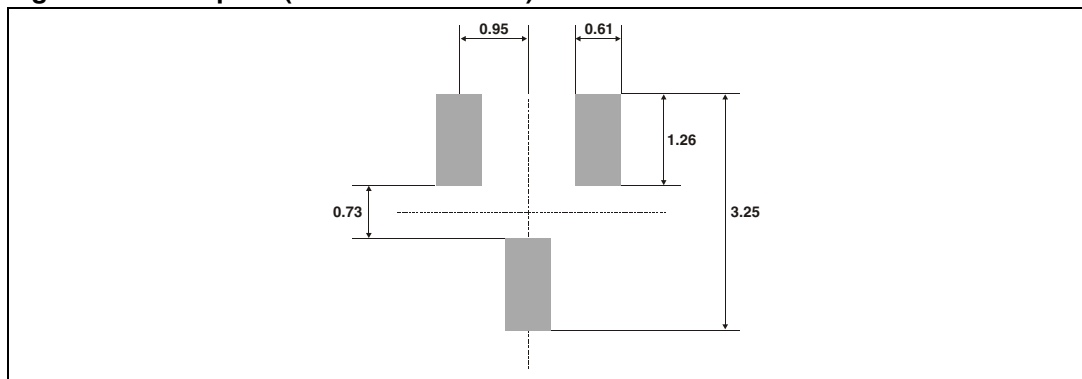
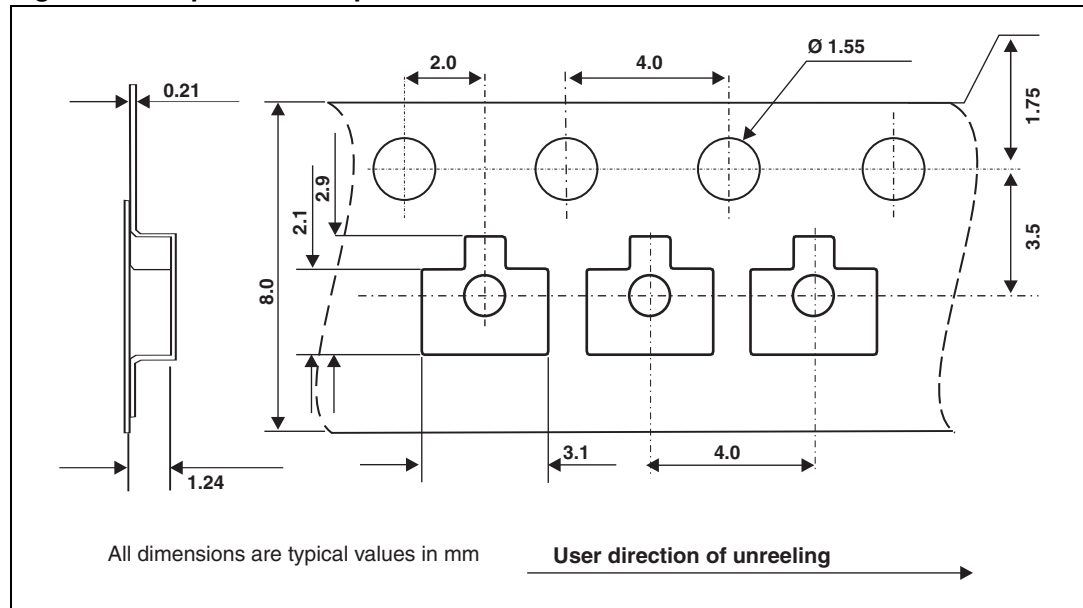

Figure 13. Tape and reel specifications



## 5 Recommendation on PCB assembly

### 5.1 Solder paste

1. Halide-free flux qualification ROL0 according to ANSI/J-STD-004.
2. “No clean” solder paste is recommended.
3. Offers a high tack force to resist component movement during high speed.
4. Solder paste with fine particles: powder particle size is 20-45  $\mu\text{m}$ .

### 5.2 Placement

1. Manual positioning is not recommended.
2. It is recommended to use the lead recognition capabilities of the placement system, not the outline centering.
3. Standard tolerance of  $\pm 0.05$  mm is recommended.
4. 3.5 N placement force is recommended. Too much placement force can lead to squeezed out solder paste and cause solder joints to short. Too low placement force can lead to insufficient contact between package and solder paste that could cause open solder joints or badly centered packages.
5. To improve the package placement accuracy, a bottom side optical control should be performed with a high resolution tool.
6. For assembly, a perfect supporting of the PCB (all the more on flexible PCB) is recommended during solder paste printing, pick and place and reflow soldering by using optimized tools.

### 5.3 PCB design preference

1. To control the solder paste amount, the closed via is recommended instead of open vias.
2. The position of tracks and open vias in the solder area should be well balanced. The symmetrical layout is recommended, in case any tilt phenomena caused by asymmetrical solder paste amount due to the solder flow away.

### 5.4 Reflow profile

Figure 14. ST ECOPACK® recommended soldering reflow profile for PCB mounting

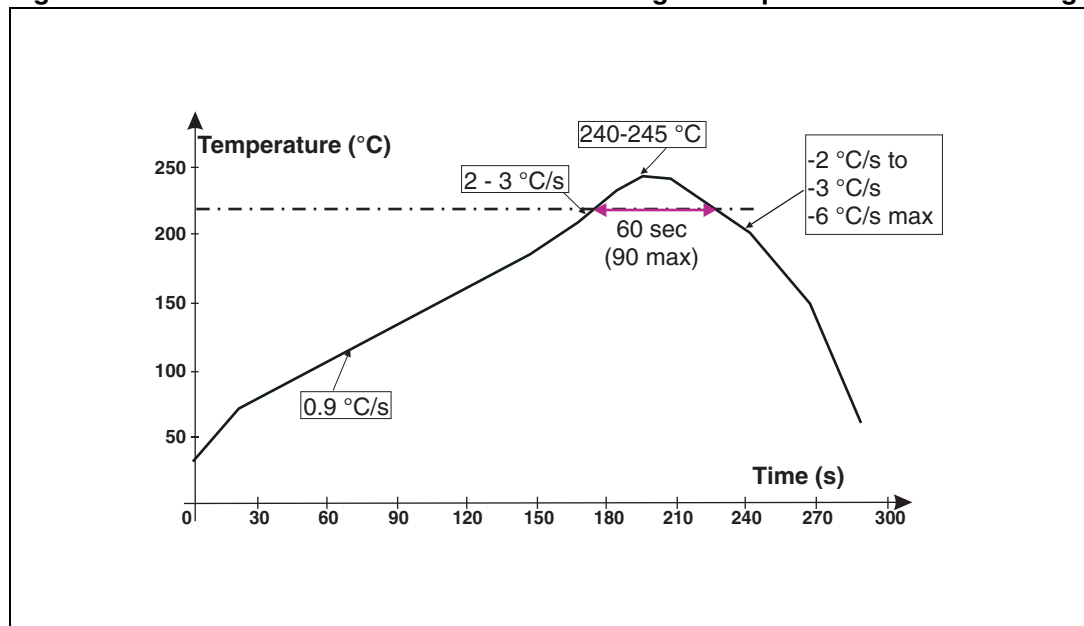

Note: Minimize air convection currents in the reflow oven to avoid component movement.



## 6 Ordering information

**Table 4. Ordering information**

| Order code | Marking <sup>(1)</sup> | Package  | Weight | Base qty | Delivery mode |
|------------|------------------------|----------|--------|----------|---------------|
| ESDA5V3LY  | EL5Y                   | SOT23-3L | 8.7 mg | 3000     | Tape and reel |
| ESDA6V1LY  | EL6Y                   |          |        |          |               |
| ESDA14V2LY | EL1Y                   |          |        |          |               |
| ESDA25LY   | EL2Y                   |          |        |          |               |

1. The marking can be rotated by multiples of 90° to differentiate assembly location

## 7 Revision history

**Table 5. Document revision history**

| Date        | Revision | Changes  |
|-------------|----------|--|
| 16-Feb-2012 | 1        | Initial version. This document merges and updates the content of the datasheet ESDA25LY Revision 1, 01-Feb-2010. |

**Please Read Carefully:**

Information in this document is provided solely in connection with ST products. STMicroelectronics NV and its subsidiaries ("ST") reserve the right to make changes, corrections, modifications or improvements, to this document, and the products and services described herein at any time, without notice.

All ST products are sold pursuant to ST's terms and conditions of sale.

Purchasers are solely responsible for the choice, selection and use of the ST products and services described herein, and ST assumes no liability whatsoever relating to the choice, selection or use of the ST products and services described herein.

No license, express or implied, by estoppel or otherwise, to any intellectual property rights is granted under this document. If any part of this document refers to any third party products or services it shall not be deemed a license grant by ST for the use of such third party products or services, or any intellectual property contained therein or considered as a warranty covering the use in any manner whatsoever of such third party products or services or any intellectual property contained therein.

**UNLESS OTHERWISE SET FORTH IN ST'S TERMS AND CONDITIONS OF SALE ST DISCLAIMS ANY EXPRESS OR IMPLIED WARRANTY WITH RESPECT TO THE USE AND/OR SALE OF ST PRODUCTS INCLUDING WITHOUT LIMITATION IMPLIED WARRANTIES OF MERCHANTABILITY, FITNESS FOR A PARTICULAR PURPOSE (AND THEIR EQUIVALENTS UNDER THE LAWS OF ANY JURISDICTION), OR INFRINGEMENT OF ANY PATENT, COPYRIGHT OR OTHER INTELLECTUAL PROPERTY RIGHT.**

**UNLESS EXPRESSLY APPROVED IN WRITING BY TWO AUTHORIZED ST REPRESENTATIVES, ST PRODUCTS ARE NOT RECOMMENDED, AUTHORIZED OR WARRANTED FOR USE IN MILITARY, AIR CRAFT, SPACE, LIFE SAVING, OR LIFE SUSTAINING APPLICATIONS, NOR IN PRODUCTS OR SYSTEMS WHERE FAILURE OR MALFUNCTION MAY RESULT IN PERSONAL INJURY, DEATH, OR SEVERE PROPERTY OR ENVIRONMENTAL DAMAGE. ST PRODUCTS WHICH ARE NOT SPECIFIED AS "AUTOMOTIVE GRADE" MAY ONLY BE USED IN AUTOMOTIVE APPLICATIONS AT USER'S OWN RISK.**

Resale of ST products with provisions different from the statements and/or technical features set forth in this document shall immediately void any warranty granted by ST for the ST product or service described herein and shall not create or extend in any manner whatsoever, any liability of ST.

ST and the ST logo are trademarks or registered trademarks of ST in various countries.

Information in this document supersedes and replaces all information previously supplied.

The ST logo is a registered trademark of STMicroelectronics. All other names are the property of their respective owners.

© 2012 STMicroelectronics - All rights reserved

STMicroelectronics group of companies

Australia - Belgium - Brazil - Canada - China - Czech Republic - Finland - France - Germany - Hong Kong - India - Israel - Italy - Japan - Malaysia - Malta - Morocco - Philippines - Singapore - Spain - Sweden - Switzerland - United Kingdom - United States of America

[www.st.com](http://www.st.com)