

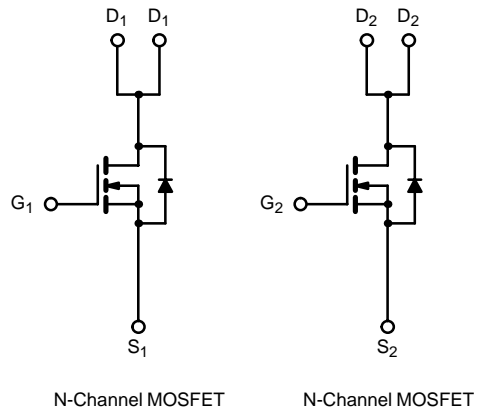

Dual N-Channel 30-V (D-S) MOSFET

PRODUCT SUMMARY

V _{DS} (V)	R _{DS(ON)} (Ω)	I _D (A)
30	0.037 @ V _{GS} = 10 V	±5.8
	0.055 @ V _{GS} = 4.5 V	±4.7

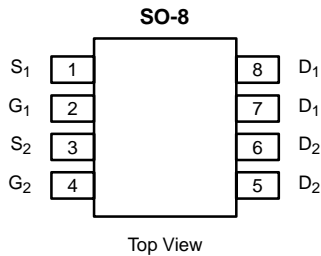

ABSOLUTE MAXIMUM RATINGS (T_A = 25°C UNLESS OTHERWISE NOTED)

PARAMETER	SYMBOL	LIMIT	UNIT
Drain-Source Voltage	V _{DS}	30	V
Gate-Source Voltage	V _{GS}	±20	
Continuous Drain Current (T _J = 150°C) ^A	I _D	T _A = 25°C	±5.8
		T _A = 70°C	±4.6
Pulsed Drain Current	I _{DM}	±30	A
Continuous Source Current (Diode Conduction) ^A	I _S	1.7	
Maximum Power Dissipation ^A	P _D	T _A = 25°C	2
		T _A = 70°C	1.3
Operating Junction and Storage Temperature Range	T _J , T _{stg}	-55 to 150	°C

THERMAL RESISTANCE RATINGS

PARAMETER	SYMBOL	LIMIT	UNIT
Maximum Junction-to-Ambient ^A	R _{thJA}	62.5	°C/W

Notes

A. Surface Mounted on FR4 Board, t ≤ 10 sec.

Updates to this data sheet may be obtained via facsimile by calling Siliconix FaxBack, 1-408-970-5600. Please request FaxBack document #70150. For SPICE model information via the Worldwide Web: <http://www.siliconix.com/www/product/spice.htm>.

**SPECIFICATIONS (T_J = 25°C UNLESS OTHERWISE NOTED)**

PARAMETER	SYMBOL	TEST CONDITION	MIN	TYP ^A	MAX	UNIT
STATIC						
Gate Threshold Voltage	V _{GS(th)}	V _{DS} = V _{GS} , I _D = 250 μA	1			V
Gate-Body Leakage	I _{GSS}	V _{DS} = 0 V, V _{GS} = ±20 V			±100	nA
Zero Gate Voltage Drain Current	I _{DSS}	V _{DS} = 30 V, V _{GS} = 0 V			1	μA
		V _{DS} = 30 V, V _{GS} = 0 V, T _J = 55°C			25	
On-State Drain Current ^B	I _{D(on)}	V _{DS} ≥ 5 V, V _{GS} = 10 V	20			A
Drain-Source On-State Resistance ^B	r _{DS(on)}	V _{GS} = 10 V, I _D = 5.8 A		0.030	0.037	Ω
		V _{GS} = 4.5 V, I _D = 4.7 A		0.042	0.055	
Forward Transconductance ^B	g _{fs}	V _{DS} = 15 V, I _D = 5.8 A		13		S
Diode Forward Voltage ^B	V _{SD}	I _S = 1.7 A, V _{GS} = 0 V		0.8	1.2	V
DYNAMIC^A						
Total Gate Charge	Q _g	V _{DS} = 15 V, V _{GS} = 10 V, I _D = 5.8 A		18	25	nC
Gate-Source Charge	Q _{gs}			4.5		
Gate-Drain Charge	Q _{gd}			2.5		
Turn-On Delay Time	t _{d(on)}	V _{DD} = 15 V, R _L = 15 Ω I _D ≅ 1 A, V _{GEN} = 10 V, R _G = 6 Ω		10	16	ns
Rise Time	t _r			10	16	
Turn-Off Delay Time	t _{d(off)}			27	40	
Fall Time	t _f			24	35	
Source-Drain Reverse Recovery Time	t _{rr}	I _F = 1.7 A, di/dt = 100 A/μs		45	80	

Notes

- A. Pulse test; pulse width ≤ 300 μs, duty cycle ≤ 2%.
 B. Guaranteed by design, not subject to production testing.



TYPICAL CHARACTERISTICS (25°C UNLESS OTHERWISE NOTED)

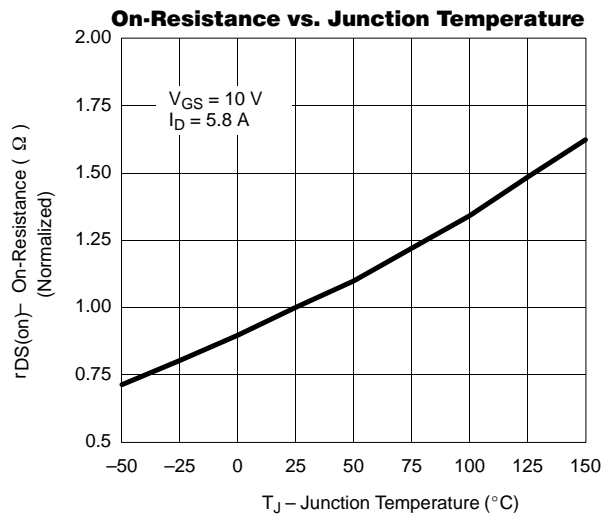
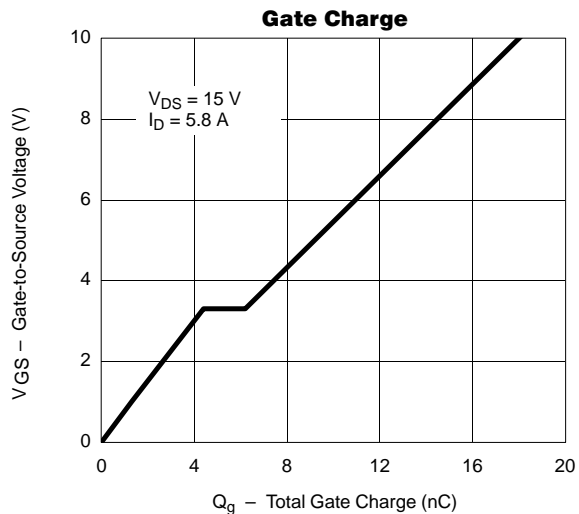
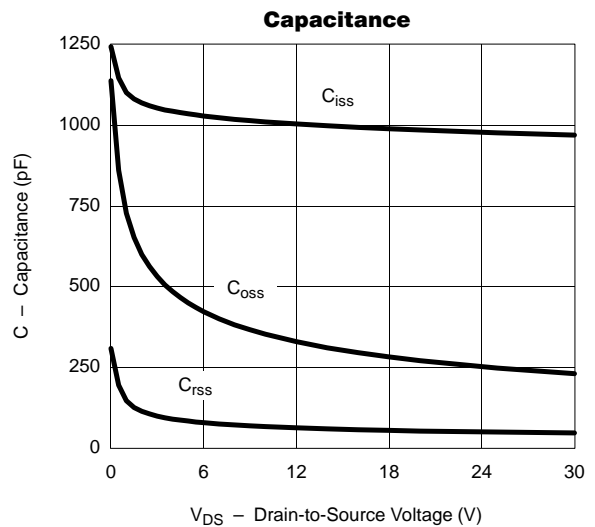
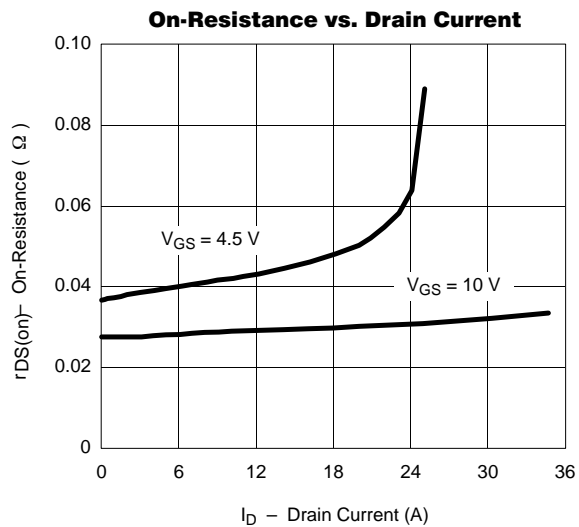
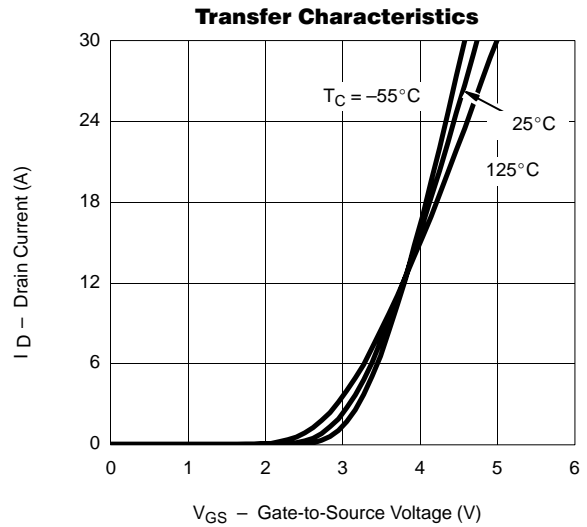
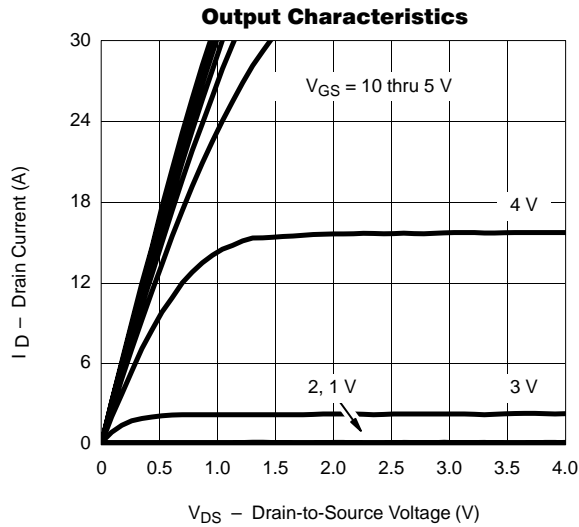



TYPICAL CHARACTERISTICS (25°C UNLESS OTHERWISE NOTED)

