

**Features**

- Low power consumption
- Robust package
- I.C. Compatible
- Standard configuration: Gray face w/ white segments
- Optional black face provides superior color contrast
- RoHS Compliant

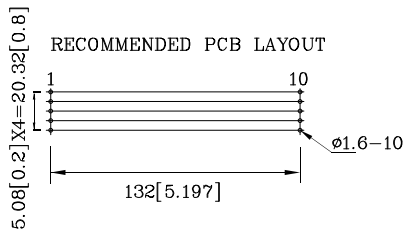

**Package Schematics**

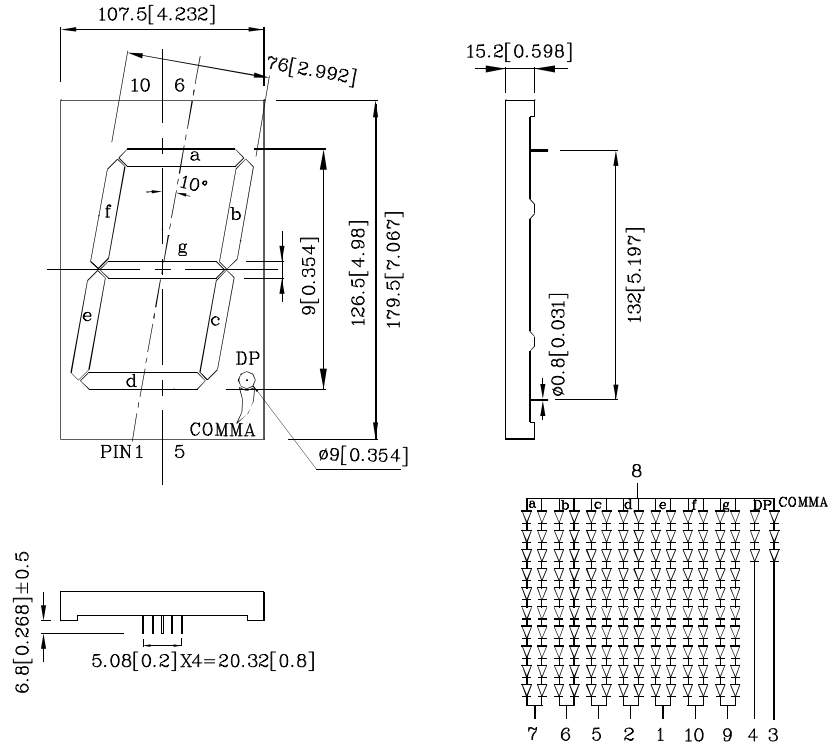

**Notes:**

1. All dimensions are in millimeters (inches), Tolerance is  $\pm 0.25(0.01)$  unless otherwise noted.
2. Specifications are subject to change without notice.

Absolute Maximum Ratings ( $T_A=25^\circ\text{C}$ )	MR (GaAlAs)	Unit
Reverse Voltage Per Segment Or (Dp And Comma)	$V_R$ 5 (5)	V
DC Forward Current Per Segment Or (Dp And Comma)	$I_F$ 60 (30)	mA
Forward Current (Peak) Per Segment Or (Dp And Comma) 1/10 Duty Cycle 0.1ms Pulse Width	$i_{FS}$ 310 (155)	mA
Power Dissipation Per Segment Or (Dp And Comma)	$P_D$ 1500 (225)	mW
Operating Temperature	$T_A$ -40 ~ +85	°C
Storage Temperature	$T_{stg}$ -40 ~ +85	
Lead Solder Temperature [2mm Below Package Base]	260°C For 3-5 Seconds	

Operating Characteristics ( $T_A=25^\circ\text{C}$ )	MR (GaAlAs)	Unit
Forward Voltage (Typ.) ( $I_F=10\text{mA}$ ) Per Segment Or (Dp And Comma)	$V_F$ 18 (5.4)	V
Forward Voltage (Max.) ( $I_F=10\text{mA}$ ) Per Segment Or (Dp And Comma)	$V_F$ 25 (7.5)	V
Reverse Current ( $V_R=5\text{V}$ ) (Max.) Per Segment Or (Dp And Comma)	$I_R$ 20 (10)	$\mu\text{A}$
Wavelength of Peak Emission CIE127-2007* (Typ.) ( $I_F=10\text{mA}$ )	$\lambda_P$ 660 655*	nm
Wavelength of Dominant Emission CIE127-2007* (Typ.) ( $I_F=10\text{mA}$ )	$\lambda_D$ 640 640*	nm
Spectral Line Full Width At Half-Maximum (Typ.) ( $I_F=10\text{mA}$ )	$\Delta\lambda$ 20	nm
Capacitance (Typ.) ( $V_F=0\text{V}$ , $f=1\text{MHz}$ )	C 45	pF

Part Number	Emitting Color	Emitting Material	Luminous Intensity CIE127-2007* ( $I_F=10\text{mA}$ ) ucd	Wavelength CIE127-2007* nm $\lambda_P$	Description
-------------	----------------	-------------------	--	---	-------------

			min.	typ.	
XDMR127A-B	Red	GaAlAs	88000 21000*	169990 43000*	660 655*
					Common Anode, Rt.Hand Decimal.

\*Luminous intensity value and wavelength are in accordance with CIE127-2007 standards.  
Jul 06,2012

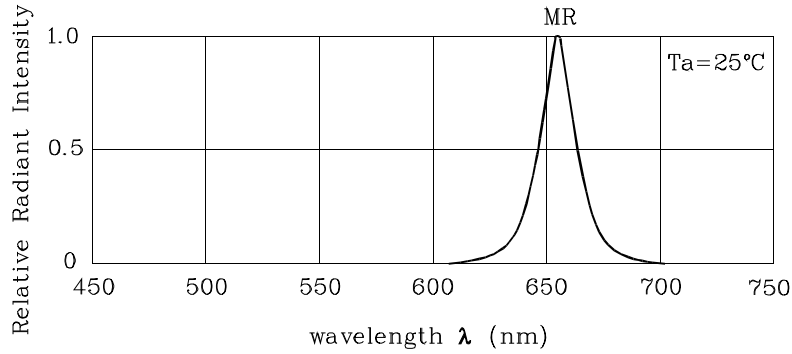

RELATIVE INTENSITY Vs. CIE WAVELENGTH

❖ MR

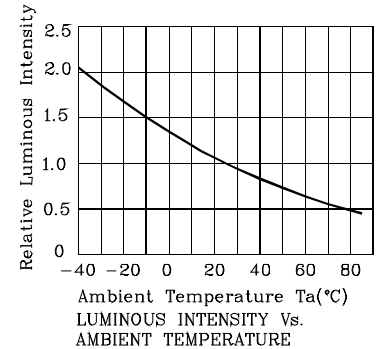
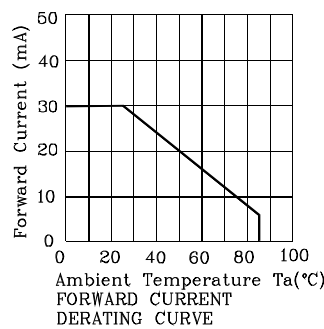
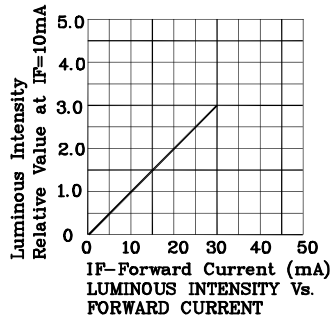
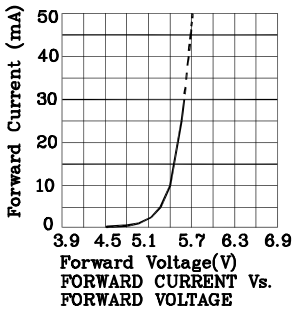
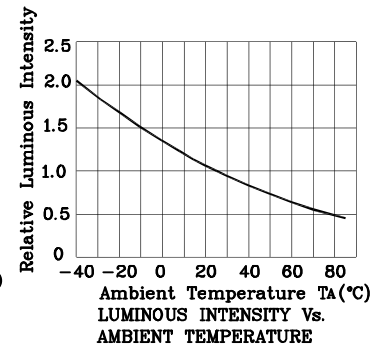
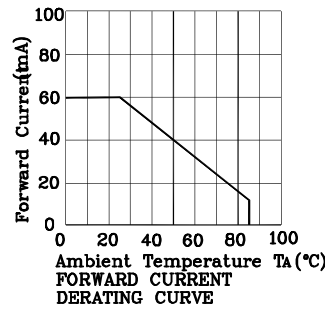
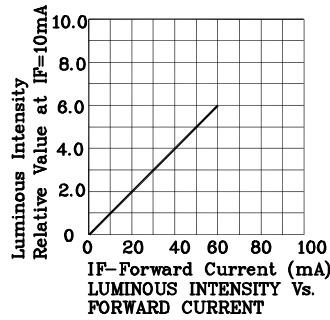
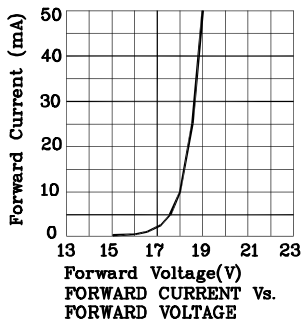

Wave Soldering Profile for Thru-Hole Products (Pb-Free Components)

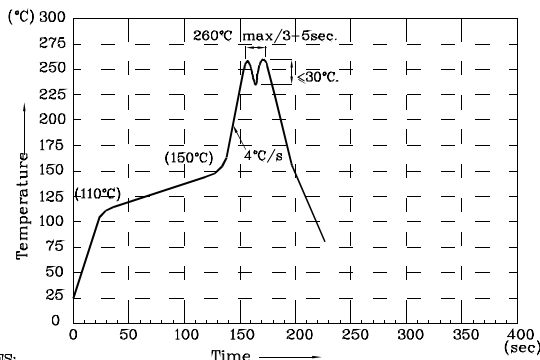

NOTES:

1. Recommend the wave temperature 245°C~260°C. The maximum soldering temperature should be less than 260°C.
2. Do not apply stress on epoxy resins when temperature is over 85°C.
3. The soldering profile apply to the lead free soldering (Sn/Cu/Ag alloy).
4. During wave soldering, the PCB top-surface temperature should be kept below 105°C.
5. No more than once.

Remarks:

If special sorting is required (e.g. binning based on forward voltage, luminous intensity / luminous flux, or wavelength), the typical accuracy of the sorting process is as follows:

1. Wavelength: +/-1nm
2. Luminous Intensity / Luminous Flux: +/-15%
3. Forward Voltage: +/-0.1V

Note: Accuracy may depend on the sorting parameters.

PACKING & LABEL SPECIFICATIONS

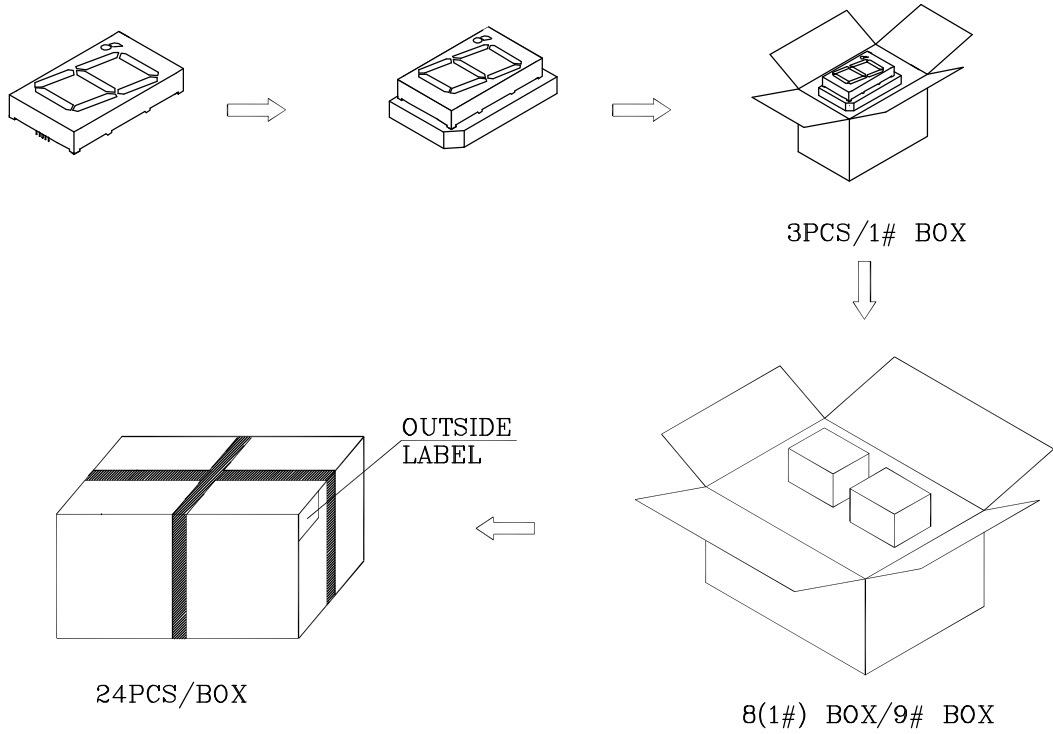

Inside Label On 1#BOX

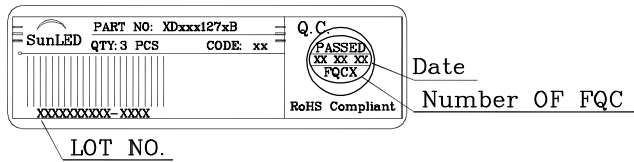

Outside Label On Box

