

**Features**

- 0.25 INCH DIGIT HEIGHT
- LOW CURRENT OPERATION.
- EXCELLENT CHARACTER APPEARANCE.
- EASY MOUNTING ON P.C. BOARDS OR SOCKETS.
- I.C. COMPATIBLE.
- CATEGORIZED FOR LUMINOUS INTENSITY.
- MECHANICALLY RUGGED.
- STANDARD : GRAY FACE, WHITE SEGMENT.
- RoHS COMPLIANT.

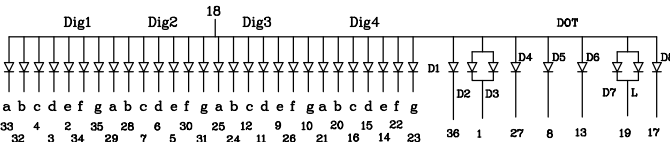
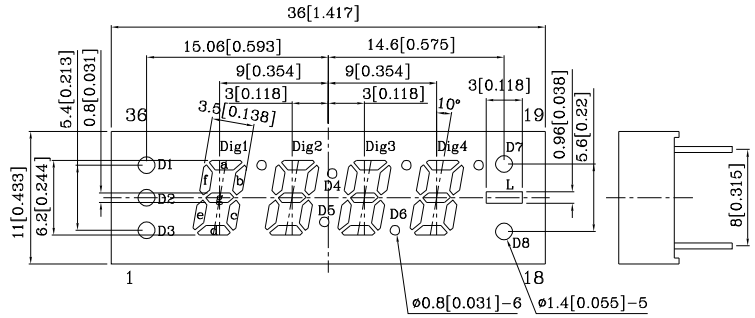

**Notes:**

1. All dimensions are in millimeters (inches).
2. Tolerance is ± 0.25(0.01") unless otherwise noted.
3. Specifications are subject to change without notice.

Absolute Maximum Ratings (TA=25°C)		UG (GaP)	Unit
Reverse Voltage	Dig1'8,'Dig2'8,'Dig3'8,'Dig4'8' D1,D4,D5,D6,D8	VR	5
	D2,D3,D7,L		
Forward Current	Dig1'8,'Dig2'8,'Dig3'8,'Dig4'8' D1,D4,D5,D6,D8	IF	25
	D2,D3,D7,L		50
Forward Current (Peak) 1/10 Duty Cycle 0.1ms Pulse Width	Dig1'8,'Dig2'8,'Dig3'8,'Dig4'8' D1,D4,D5,D6,D8	iFS	140
	D2,D3,D7,L		280
Power Dissipation	Dig1'8,'Dig2'8,'Dig3'8,'Dig4'8' D1,D4,D5,D6,D8	PT	62.5
	D2,D3,D7,L		125
Operating Temperature	TA	-40 ~ +85	°C
Storage Temperature	Tstg	-40 ~ +85	
Lead Solder Temperature [2mm Below Package Base]	260°C For 3~5 Seconds		

Operating Characteristics (TA=25°C)		UG (GaP)	Unit
Forward Voltage (Typ.) (IF=10mA)	Dig1'8,'Dig2'8,'Dig3'8,'Dig4'8' D1,D4,D5,D6,D8	VF	2.0
	D2,D3,D7,L		
Forward Voltage (Max.) (IF=10mA)	Dig1'8,'Dig2'8,'Dig3'8,'Dig4'8' D1,D4,D5,D6,D8	VF	2.5
	D2,D3,D7,L		
Reverse Current (Max.) (VR=5V)	Dig1'8,'Dig2'8,'Dig3'8,'Dig4'8' D1,D4,D5,D6,D8	IR	10
	D2,D3,D7,L		20
Wavelength of Peak (Typ.) Emission (IF=10mA)	λ P	565	nm
Wavelength of Dominant Emission (Typ.) (IF=10mA)	λ D	568	nm
Spectral Line Full Width (Typ.) At Half-Maximum (IF=10mA)	Δλ	30	nm
Capacitance (Typ.) (VF=0V, f=1MHz)	C	15	pF

Part Number	Emitting Color	Emitting Material	Luminous Intensity (IF=10mA) ucd		Wavelength nm $\lambda_P$	Description
			min.	typ.		
XDUG06A4	Green	GaP	1900	10490	565	Common Anode

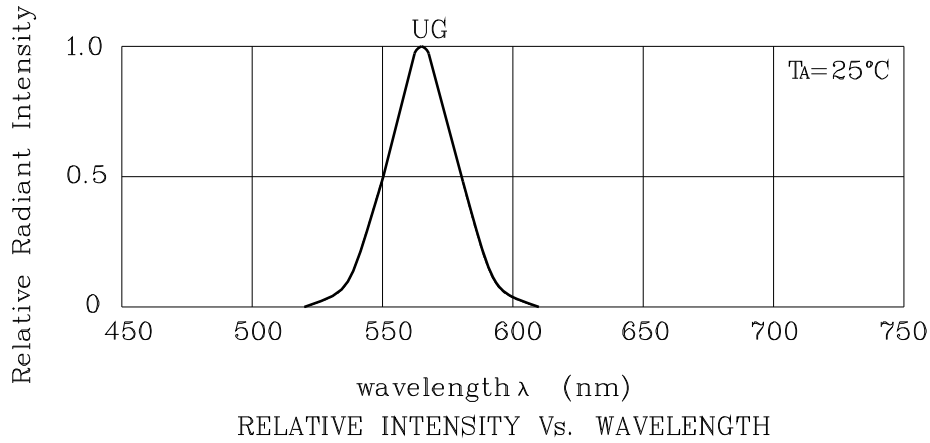

❖ UG

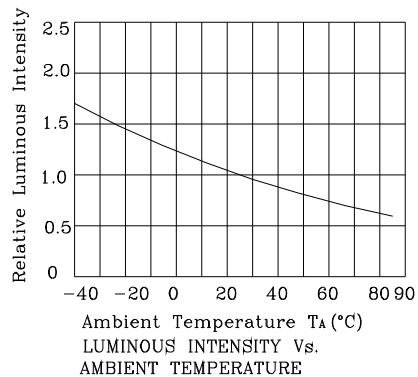
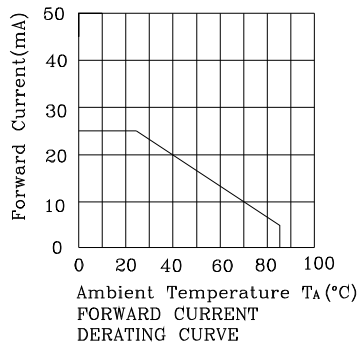
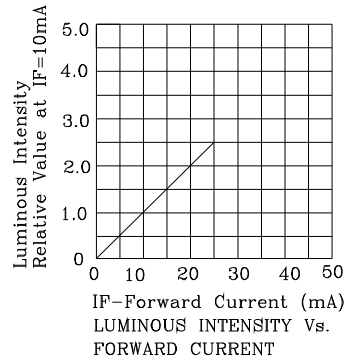
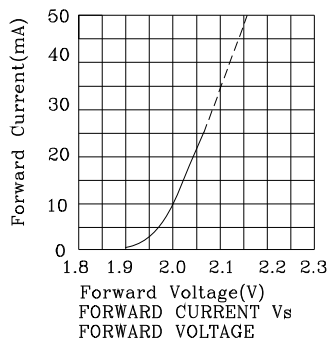

❖ UG

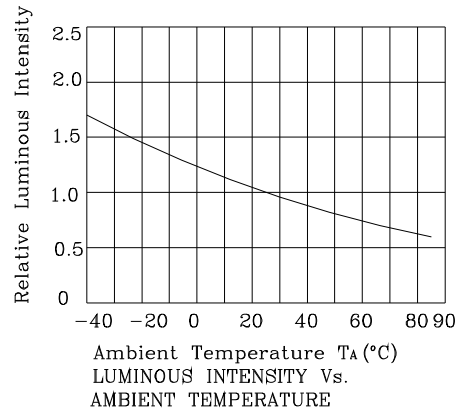
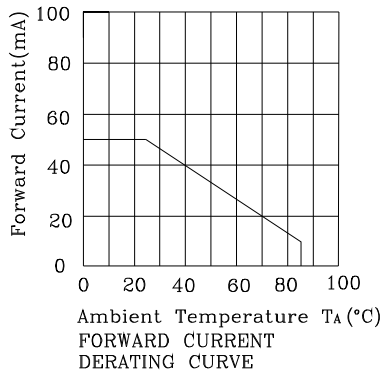
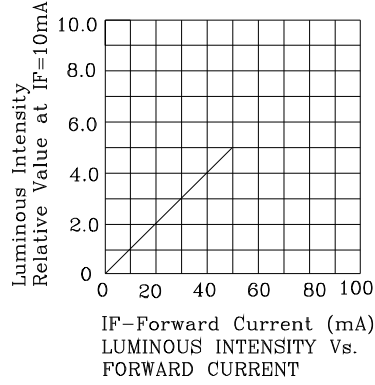
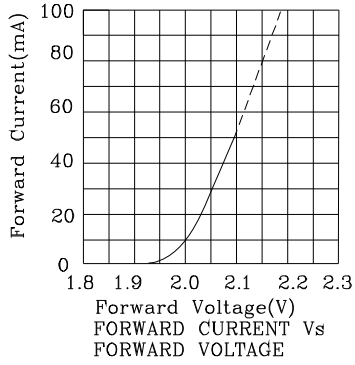

Wave Soldering Profile For Lead-free Through-hole LED.

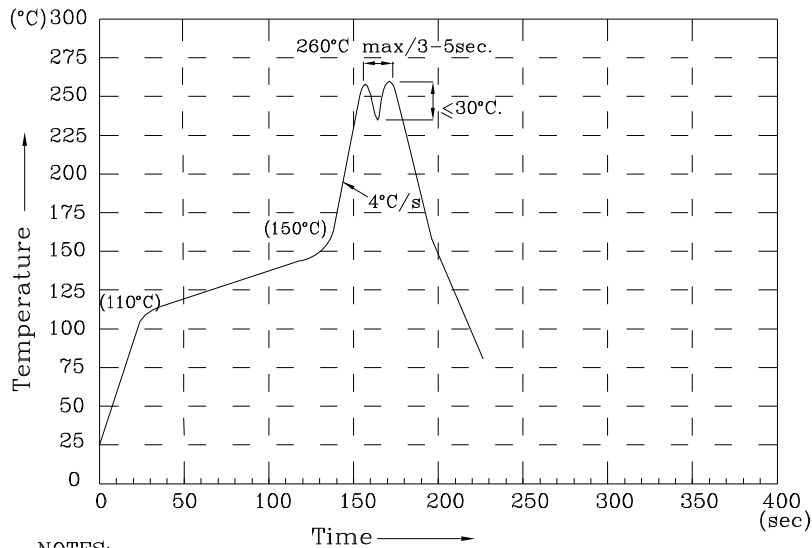

NOTES:

- 1.Recommend the wave temperature 245°C~260°C.The maximum soldering temperature should be less than 260°C.
- 2.Do not apply stress on epoxy resins when temperature is over 85 degree°C.
- 3.The soldering profile apply to the lead free soldering (Sn/Cu/Ag alloy).
- 4.No more than once.

Remarks:

If special sorting is required (e.g. binning based on forward voltage, luminous intensity/ luminous flux or wavelength), the typical accuracy of the sorting process is as follows:

1. Wavelength: +/-1nm
2. Luminous Intensity/ luminous flux: +/-15%
3. Forward Voltage: +/-0.1V

Note: Accuracy may depend on the sorting parameters.

**PACKING & LABEL SPECIFICATIONS**

**XDUG06A4**

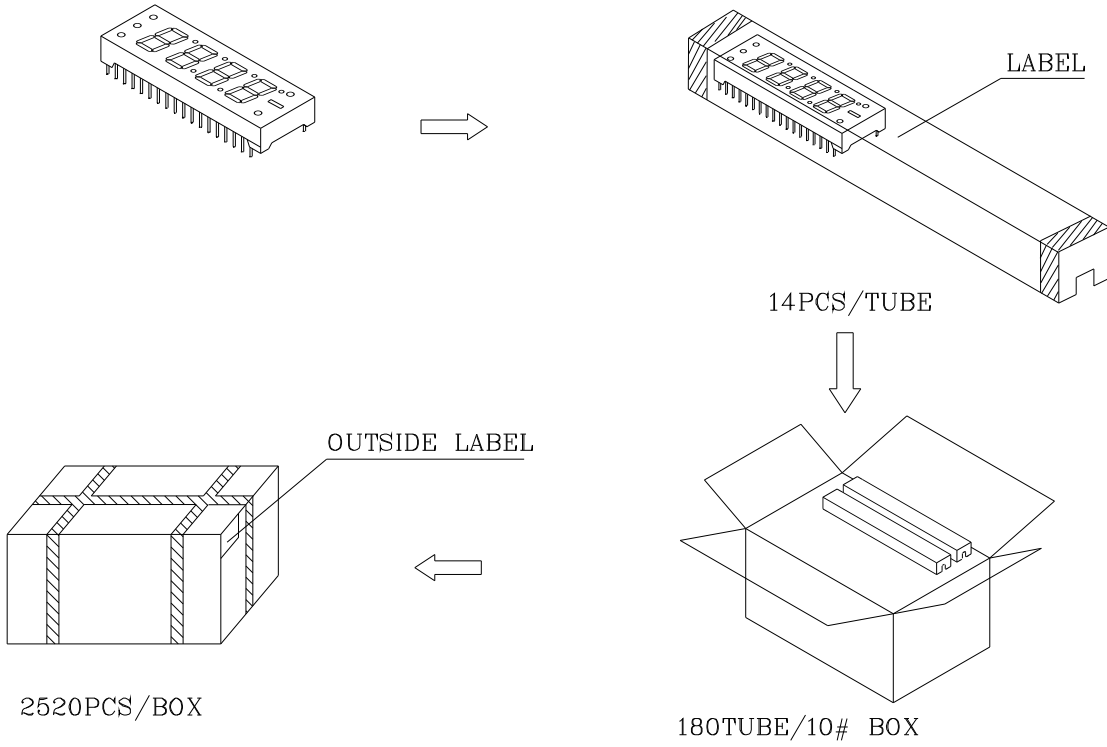

Inside LABEL Paste On The IC-tube

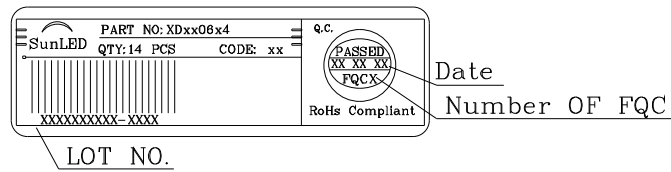

Outside LABEL Paste On The Box

