

Features

- 0.25 INCH DIGIT HEIGHT.
- LOW CURRENT OPERATION.
- EXCELLENT CHARACTER APPEARANCE.
- EASY MOUNTING ON P.C. BOARDS OR SOCKETS.
- I.C. COMPATIBLE.
- CATEGORIZED FOR LUMINOUS INTENSITY.
- MECHANICALLY RUGGED.
- STANDARD : GRAY FACE, WHITE SEGMENT.
- RoHS COMPLIANT.

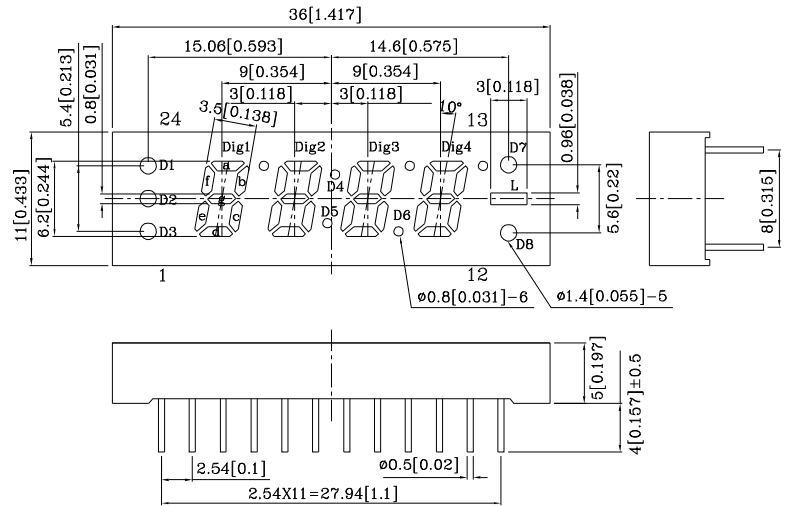
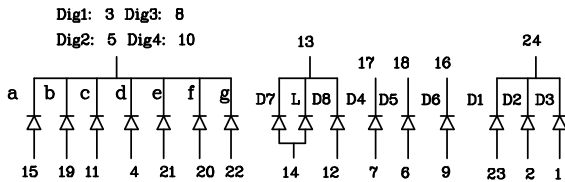

Notes:

1. All dimensions are in millimeters (inches).
2. Tolerance is $\pm 0.25(0.01)$ unless otherwise noted.
3. Specifications are subject to change without notice.

Absolute Maximum Ratings (TA=25°C)		UR (GaAsP/ GaP)	Unit
Reverse Voltage	Dig1'8,'Dig2'8',Dig3'8',Dig4'8' D1,D2,D3,D4,D5,D6,D8	V _R	5
	D7,L		
Forward Current	Dig1'8,'Dig2'8',Dig3'8',Dig4'8' D1,D2,D3,D4,D5,D6,D8	I _F	30
	D7,L		60
Forward Current (Peak) 1/10 Duty Cycle 0.1ms Pulse Width	Dig1'8,'Dig2'8',Dig3'8',Dig4'8' D1,D2,D3,D4,D5,D6,D8	i _{FS}	160
	D7,L		320
Power Dissipation	Dig1'8,'Dig2'8',Dig3'8',Dig4'8' D1,D2,D3,D4,D5,D6,D8	P _T	75
	D7,L		150
Operating Temperature	T _A		-40 ~ +85
Storage Temperature	T _{stg}		-40 ~ +85
Lead Solder Temperature [2mm Below Package Base]	260°C For 3~5 Seconds		

Operating Characteristics (TA=25°C)		UR (GaAsP/ GaP)	Unit
Forward Voltage (Typ.) (IF=10mA)	Dig1'8,'Dig2'8',Dig3'8',Dig4'8' D1,D2,D3,D4,D5,D6,D8	V _F	1.9
	D7,L		
Forward Voltage (Max.) (IF=10mA)	Dig1'8,'Dig2'8',Dig3'8',Dig4'8' D1,D2,D3,D4,D5,D6,D8	V _F	2.5
	D7,L		
Reverse Current (Max.) (VR=5V)	Dig1'8,'Dig2'8',Dig3'8',Dig4'8' D1,D2,D3,D4,D5,D6,D8	I _R	10
	D7,L		20
Wavelength of Peak Emission (Typ.)	λ _P		627
Wavelength of Dominant Emission (Typ.) (IF=10mA)	λ _D		625
Spectral Line Full Width (Typ.) At Half-Maximum (IF=10mA)	Δλ		45
Capacitance (Typ.) (VF=0V, f=1MHz)	C		15

Part Number	Emitting Color	Emitting Material	Luminous Intensity (IF=10mA) ucd		Wavelength nm λ P	Description
			min.	typ.		
XDUR06C4-A	Red	GaAsP/GaP	1200	6390	627	Common Cathode

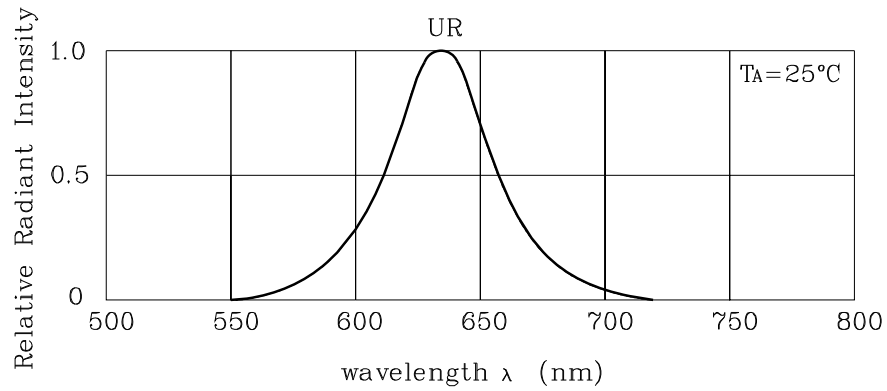

RELATIVE INTENSITY Vs. WAVELENGTH

❖ UR

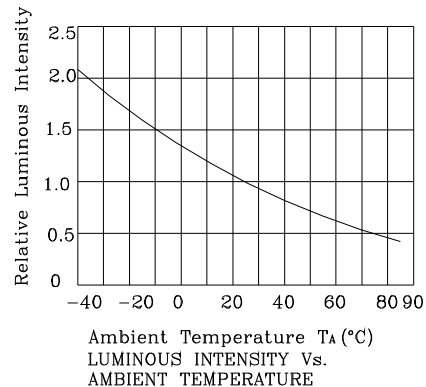
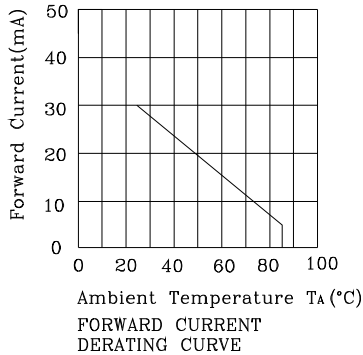
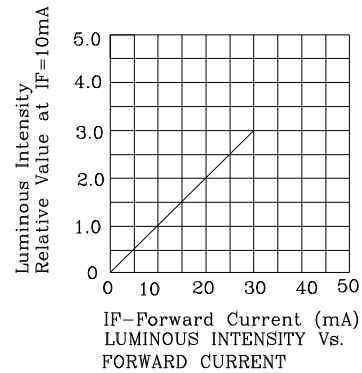
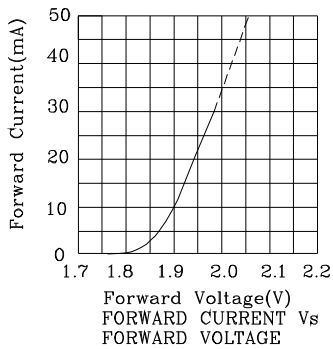

❖ UR

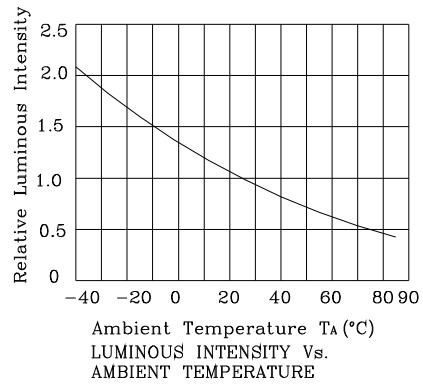
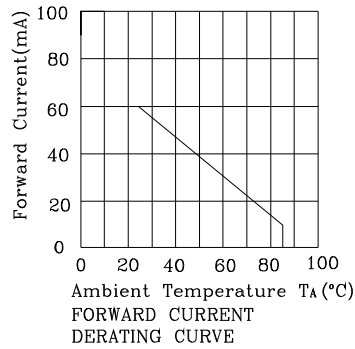
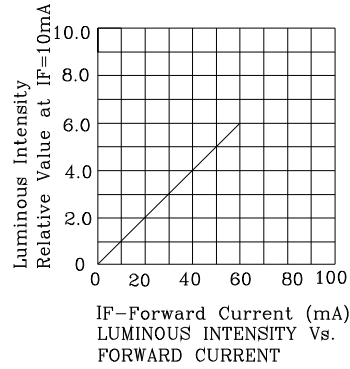
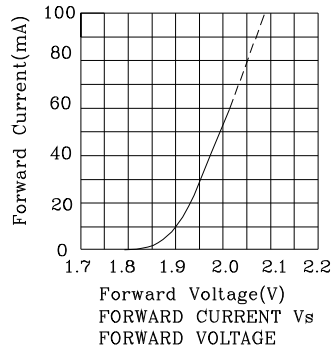

Wave Soldering Profile For Lead-free Through-hole LED.

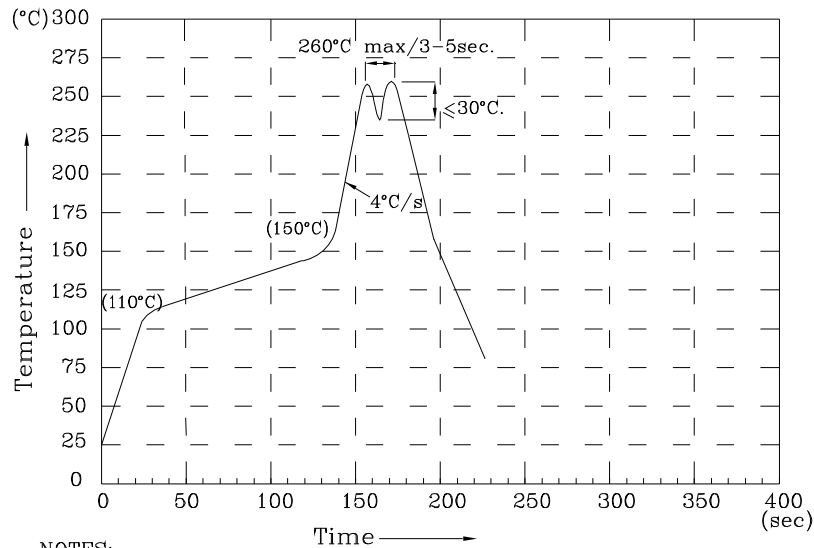

NOTES:

1. Recommend the wave temperature 245°C~260°C. The maximum soldering temperature should be less than 260°C.
2. Do not apply stress on epoxy resins when temperature is over 85 degree°C.
3. The soldering profile apply to the lead free soldering (Sn/Cu/Ag alloy).
4. No more than once.

Remarks:

If special sorting is required (e.g. binning based on forward voltage, luminous intensity/ luminous flux or wavelength), the typical accuracy of the sorting process is as follows:

1. Wavelength: +/-1nm
2. Luminous Intensity/ luminous flux: +/-15%
3. Forward Voltage: +/-0.1V

Note: Accuracy may depend on the sorting parameters.

PACKING & LABEL SPECIFICATIONS

XDUR06C4-A

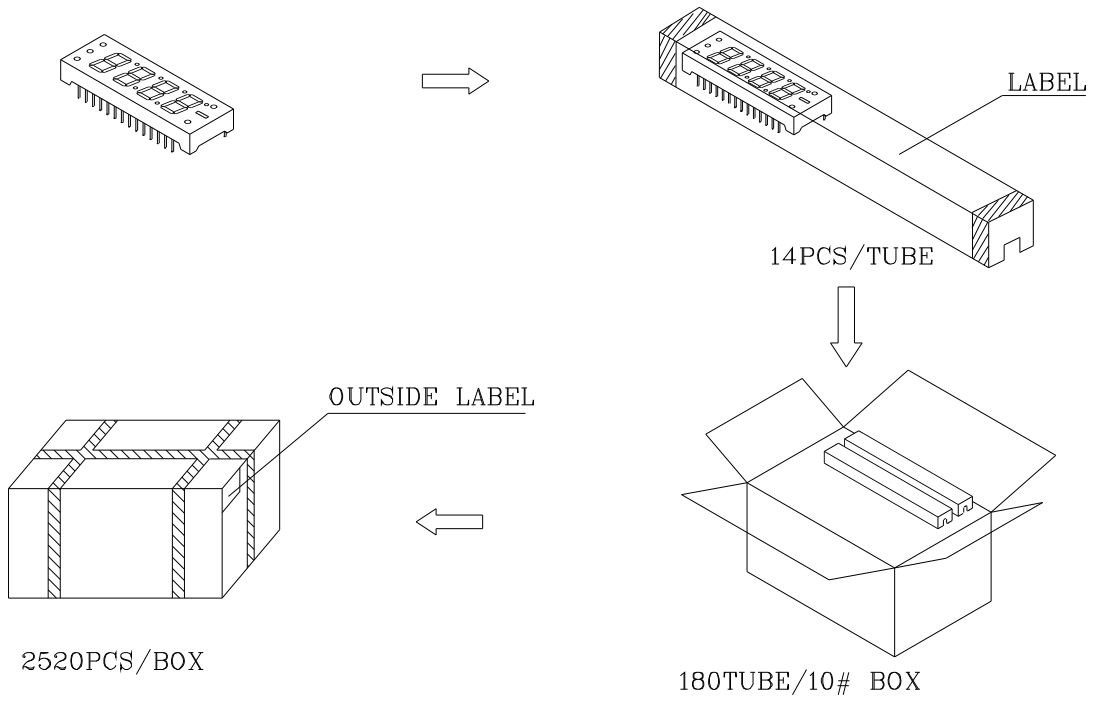

Inside LABEL Paste On The IC-tube

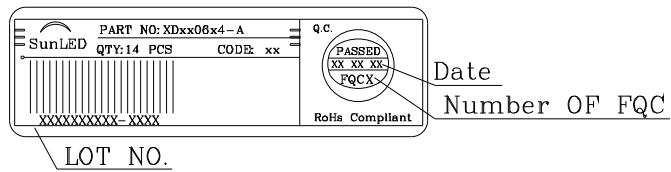

Outside LABEL Paste On The Box

