

Features

- 1.5 INCH DIGIT HEIGHT.
- LOW CURRENT OPERATION.
- EXCELLENT CHARACTER APPEARANCE.
- HIGH LIGHT OUTPUT.
- EASY MOUNTING ON P.C. BOARDS OR SOCKETS.
- I.C. COMPATIBLE.
- MECHANICALLY RUGGED.
- STANDARD : GRAY FACE, WHITE SEGMENT.
- RoHS COMPLIANT.

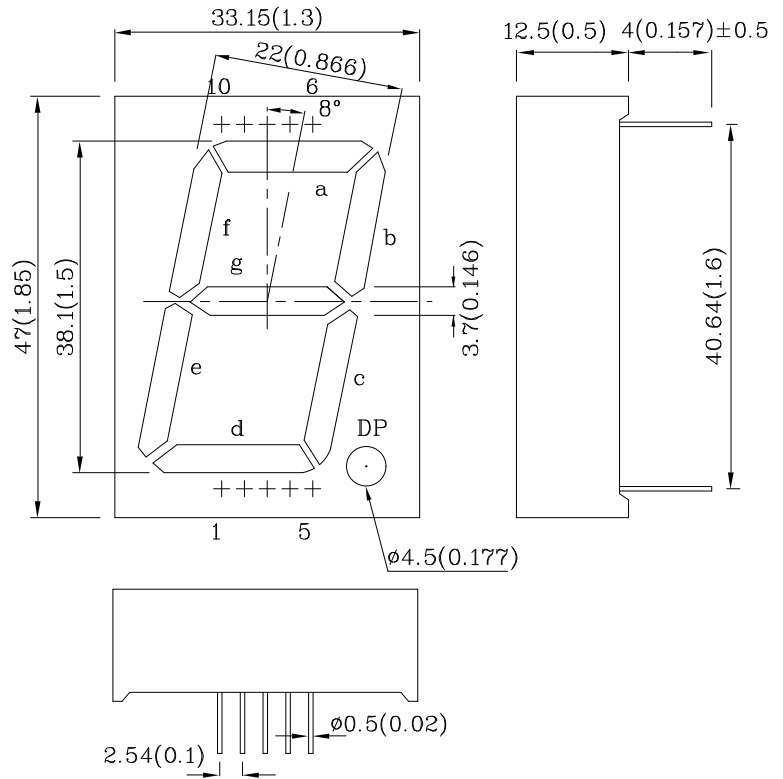
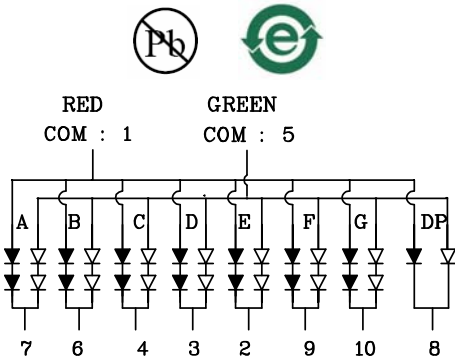

Notes:

1. All dimensions are in millimeters (inches).
2. Tolerance is $\pm 0.25(0.01)$ " unless otherwise noted.
3. Specifications are subject to change without notice.

Absolute Maximum Ratings (TA=25°C)		UR (GaAsP/ GaP)	UG (GaP)	Unit
Reverse Voltage Per Segment or (Dp)	VR	10(5)	10(5)	V
Forward Current Per Segment or (Dp)	IF	30(30)	25(25)	mA
Forward Current (Peak) 1/10 Duty Cycle 0.1ms Pulse Width Per Segment or (Dp)	iFS	160(160)	140 (140)	mA
Power Dissipation Per Segment or (Dp)	PT	150 (75)	125 (62.5)	mW
Operating Temperature	TA	-40 ~ +85		°C
Storage Temperature	Tstg	-40 ~ +85		
Lead Solder Temperature [2mm Below Package Base]	260°C For 3-5 Seconds			

Operating Characteristics (TA=25°C)		UR (GaAsP/ GaP)	UG (GaP)	Unit
Forward Voltage (Typ.) (IF=10mA) Per Segment or (Dp)	VF	3.8 (1.9)	4.0 (2.0)	V
Forward Voltage (Max.) (IF=10mA) Per Segment or (Dp)	VF	5.0 (2.5)	5.0 (2.5)	V
Reverse Current (VR=10V(5V)) Per Segment or (Dp)	IR	10 (10)	10 (10)	uA
Wavelength of Peak Emis- sion (IF=10mA)	λP	627	565	nm
Wavelength of Dominant Emission (IF=10mA)	λD	625	568	nm
Spectral Line Full Width At Half-Maximum (IF=10mA)	$\Delta\lambda$	45	30	nm
Capacitance (VF=0V, f=1MHz)	C	15	15	pF

Part Number	Emitting Color	Emitting Material	Luminous Intensity (IF=10mA) ucd		Wavelength nm λ P	Description
			min.	typ.		
XDURG38A	Red	GaAsP/GaP	3000	15990	627	Common Anode, Rt. Hand Decimal
	Green	GaP	4700	23990	565	

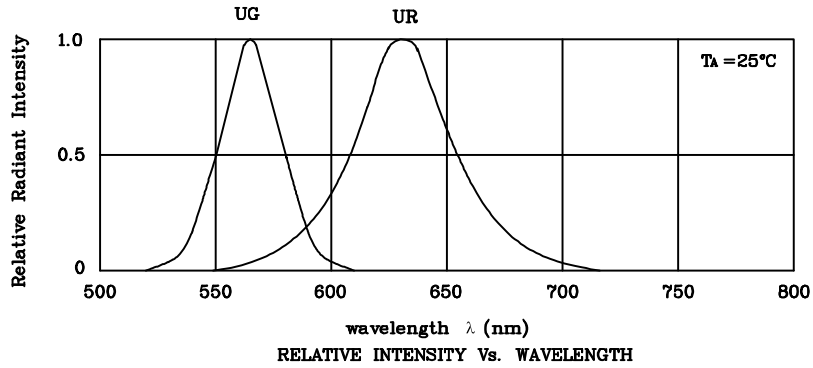

❖ UR

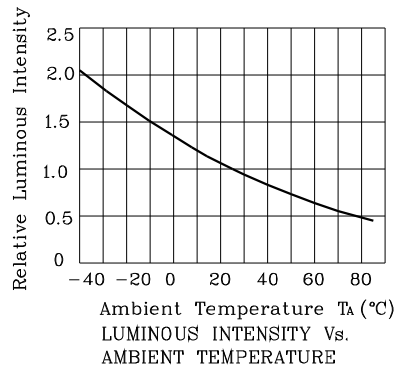
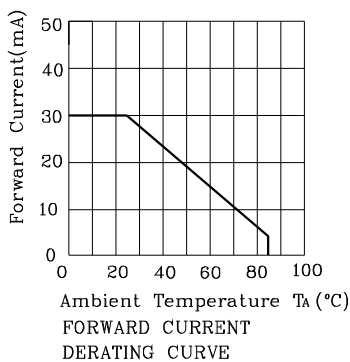
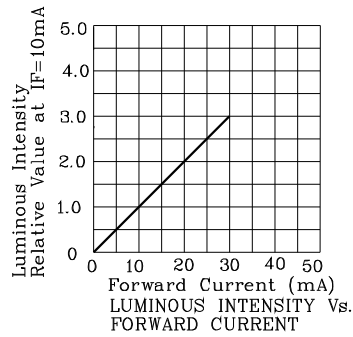
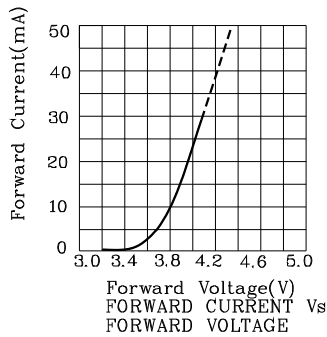

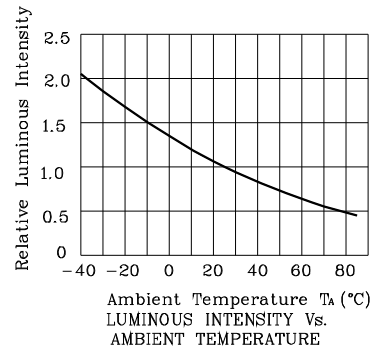
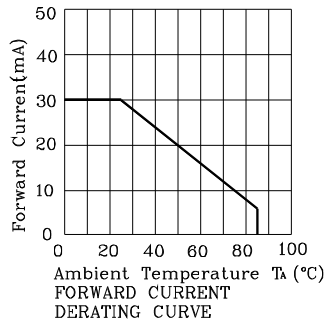
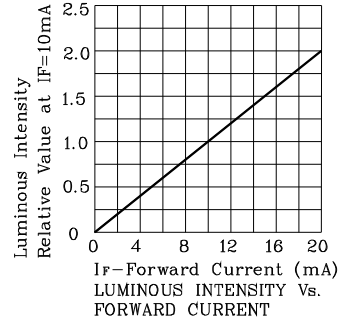
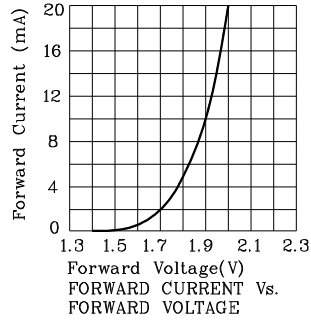

❖ UG

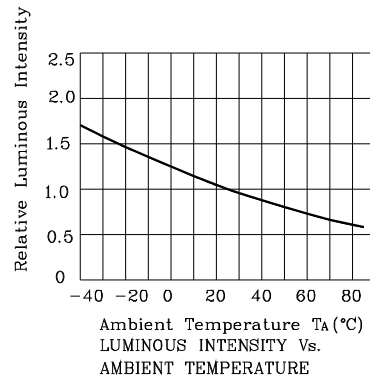
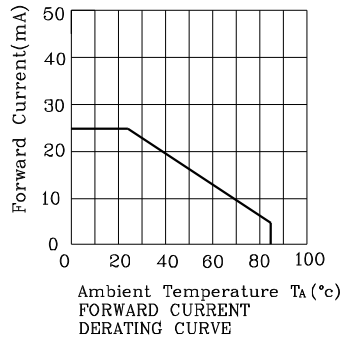
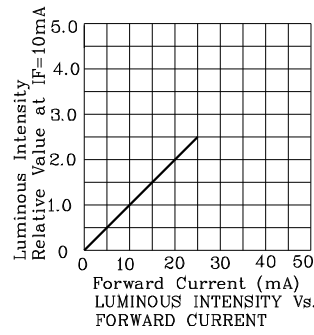
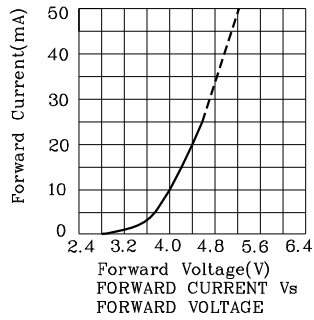

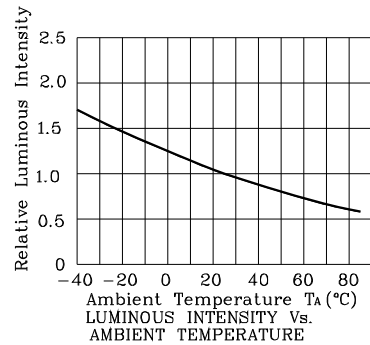
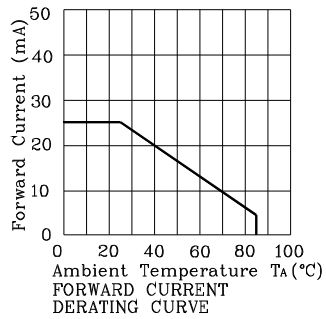
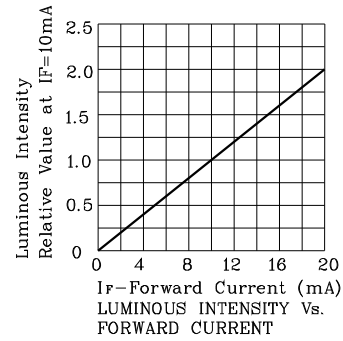
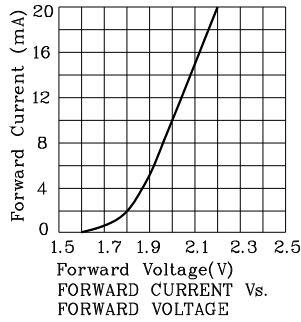

Wave Soldering Profile For Lead-free Through-hole LED.

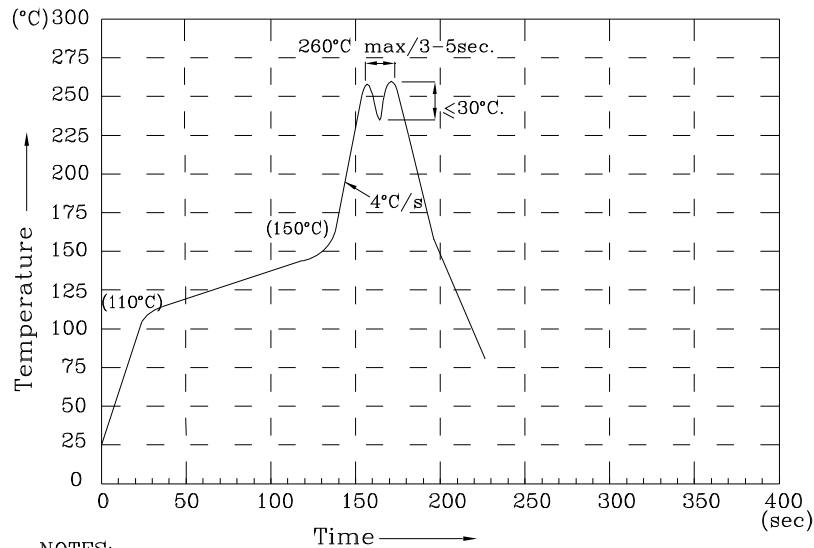

NOTES:

1. Recommend the wave temperature 245°C~260°C. The maximum soldering temperature should be less than 260°C.
2. Do not apply stress on epoxy resins when temperature is over 85 degree°C.
3. The soldering profile apply to the lead free soldering (Sn/Cu/Ag alloy).
4. No more than once.

Remarks:

If special sorting is required (e.g. binning based on forward voltage, luminous intensity/ luminous flux or wavelength), the typical accuracy of the sorting process is as follows:

1. Wavelength: +/-1nm
2. Luminous Intensity/ luminous flux: +/-15%
3. Forward Voltage: +/-0.1V

Note: Accuracy may depend on the sorting parameters.

PACKING & LABEL SPECIFICATIONS

XDURG38A

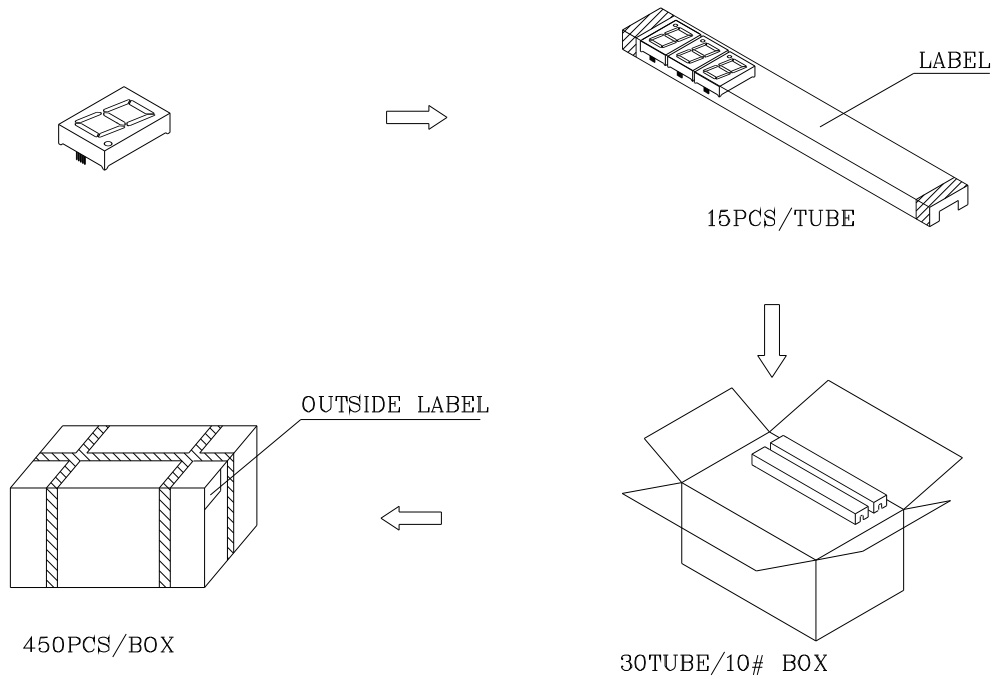

Inside LABEL Paste On The IC-tube

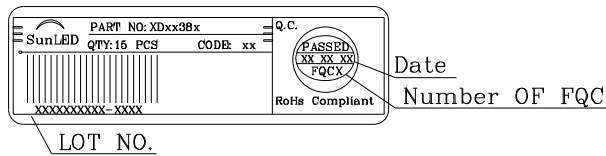

Outside LABEL Paste On The Box

