

### Features

- Radial / Through hole package
- Reliable & robust
- Low power consumption
- Available on tape and reel
- RoHS Compliant

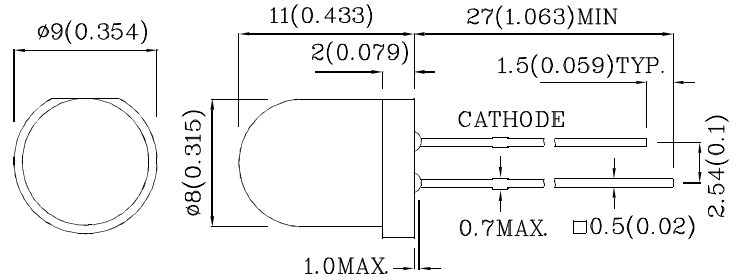

### Package Schematics



#### Notes:

1. All dimensions are in millimeters (inches).
2. Tolerance is  $\pm 0.25(0.01)$ " unless otherwise noted.
3. Specifications are subject to change without notice.

Absolute Maximum Ratings ( $T_A=25^\circ\text{C}$ )		UR (GaAsP/GaP)	Unit
Reverse Voltage	$V_R$	5	V
Forward Current	$I_F$	30	mA
Forward Current (Peak) 1/10 Duty Cycle 0.1ms Pulse Width	$i_{FS}$	160	mA
Power Dissipation	$P_D$	75	mW
Operating Temperature	$T_A$	-40 ~ +85	°C
Storage Temperature	$T_{stg}$	-40 ~ +85	
Lead Solder Temperature [2mm Below Package Base]	260°C For 3 Seconds		
Lead Solder Temperature [5mm Below Package Base]	260°C For 5 Seconds		

Operating Characteristics ( $T_A=25^\circ\text{C}$ )		UR (GaAsP/GaP)	Unit
Forward Voltage (Typ.) ( $I_F=20\text{mA}$ )	$V_F$	2	V
Forward Voltage (Max.) ( $I_F=20\text{mA}$ )	$V_F$	2.5	V
Reverse Current (Max.) ( $V_R=5\text{V}$ )	$I_R$	10	uA
Wavelength of Peak Emission CIE127-2007*(Typ.) ( $I_F=20\text{mA}$ )	$\lambda_P$	627 627*	nm
Wavelength of Dominant Emission CIE127-2007*(Typ.) ( $I_F=20\text{mA}$ )	$\lambda_D$	625 617*	nm
Spectral Line Full Width At Half-Maximum (Typ.) ( $I_F=20\text{mA}$ )	$\Delta\lambda$	45	nm
Capacitance (Typ.) ( $V_F=0\text{V}$ , $f=1\text{MHz}$ )	C	15	pF

Part Number	Emitting Color	Emitting Material	Lens-color	Luminous Intensity CIE127-2007* ( $I_F=20\text{mA}$ ) mcd		Wavelength CIE127-2007* nm $\lambda_P$	Viewing Angle 2 $\theta$ 1/2
				min.	typ.		
XLUR81D	Red	GaAsP/GaP	Red Diffused	50 30*	98 60*	627 627*	30°

\*Luminous intensity value and wavelength are in accordance with CIE127-2007 standards.

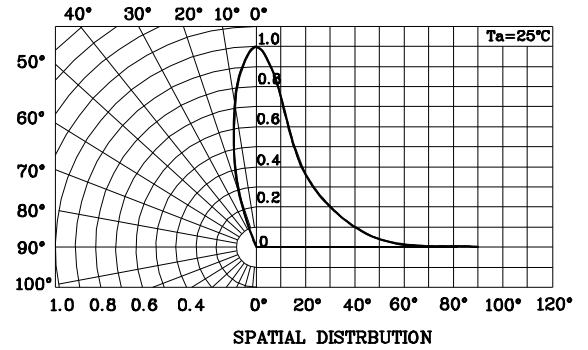
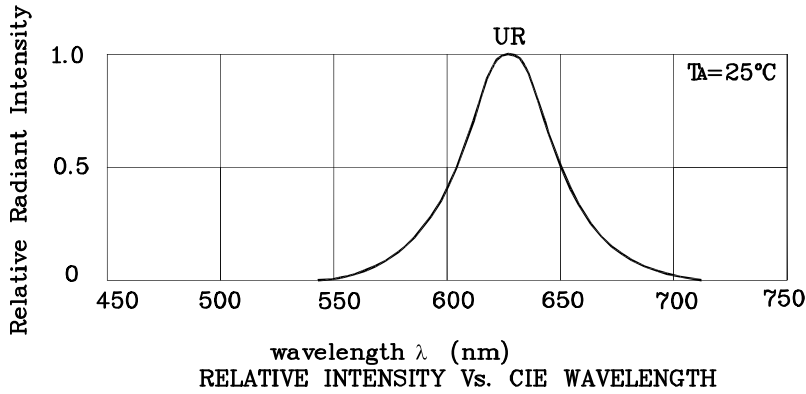

❖ UR

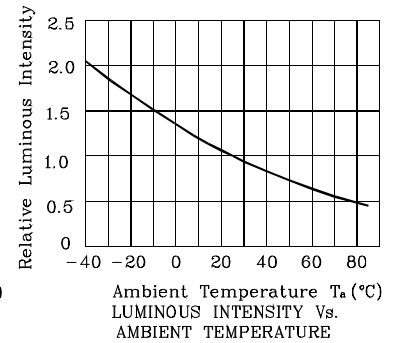
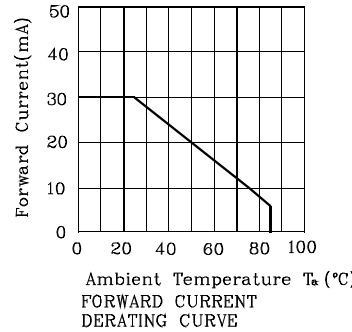
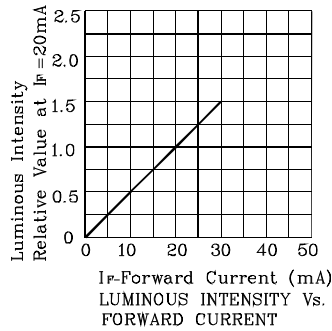
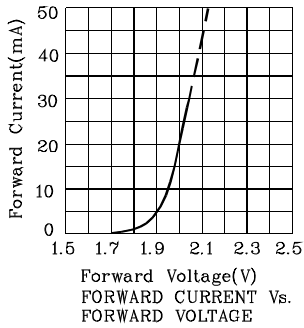

Wave Soldering Profile For Thru-Hole Products (Pb-Free Components)

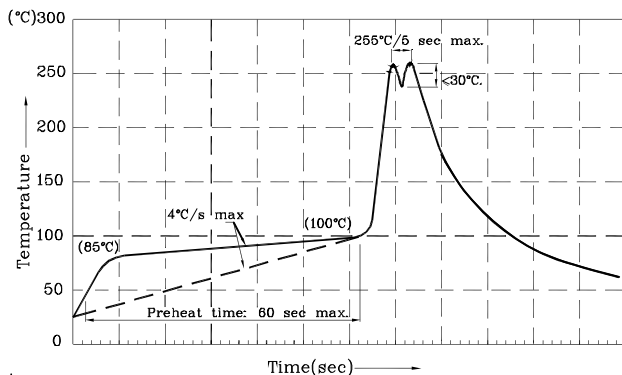

Notes:

1. Recommend pre-heat temperature of 105°C or less (as measured with a thermocouple attached to the LED pins) prior to immersion in the solder wave with a maximum solder bath temperature of 280°C
2. Peak wave soldering temperature between 245°C ~ 255°C for 3 sec (5 sec max).
3. Do not apply stress to the epoxy resin while the temperature is above 85°C.
4. Fixtures should not incur stress on the component when mounting and during soldering process.
5. SAC 305 solder alloy is recommended.
6. No more than one wave soldering pass.



Remarks:



If special sorting is required (e.g. binning based on forward voltage, luminous intensity / luminous flux, or wavelength), the typical accuracy of the sorting process is as follows:

1. Wavelength: +/-1nm
2. Luminous Intensity / Luminous Flux: +/-15%
3. Forward Voltage: +/-0.1V

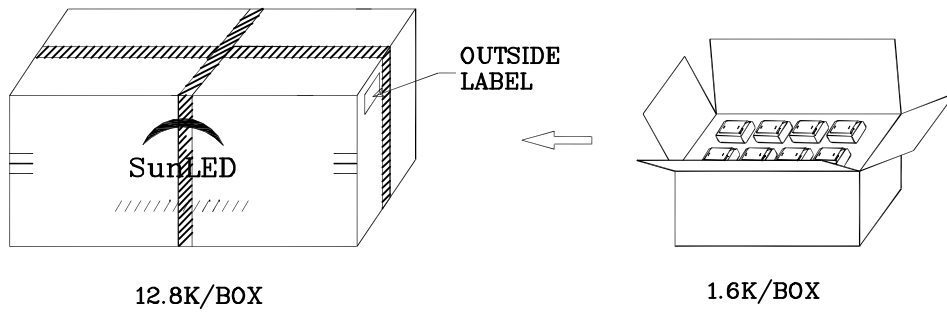
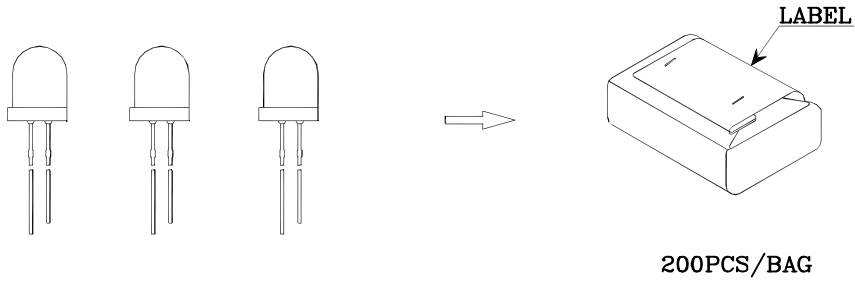
Note: Accuracy may depend on the sorting parameters.

**PACKING & LABEL SPECIFICATIONS**

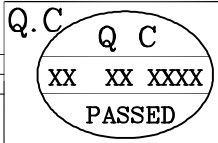
	
P/NO : XLxx81x	
QTY : 200 pcs	CODE: XXX
S/N : XX	
LOT NO:	
	
<p>XXXXXXXXXXXXXXXXXXXX</p> <p style="text-align: right;">RoHS Compliant</p>	