

**Features**

- BLACK CASE ENHANCES CONTRAST.
- VIBRATION AND SHOCK RESISTANT.
- AVAILABLE WITH A VARIETY OF LEDs.
- UL RATING : 94V-0.
- HOUSING MATERIAL: TYPE 66 NYLON.
- 5V INTERNAL RESISTOR.
- RoHS COMPLIANT.

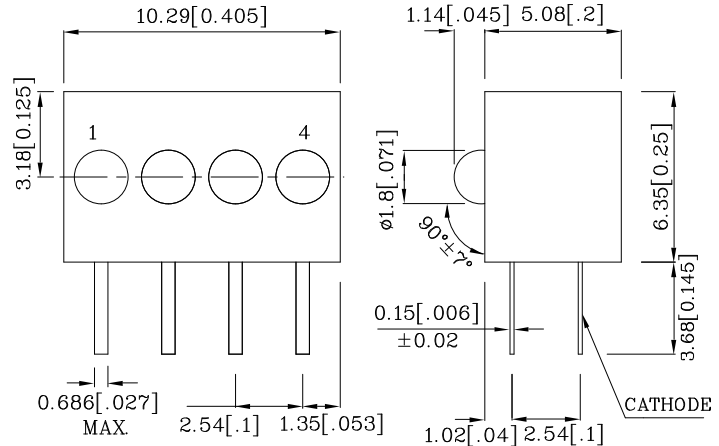

Notes:

1. All dimensions are in millimeters (inches).
2. Tolerance is ± 0.25(0.01") unless otherwise noted.
3. Specifications are subject to change without notice.

Absolute Maximum Ratings (TA=25°C)		MR (GaAlAs)	Unit
Reverse Voltage	VR	5	V
Forward Voltage	VF	6	V
Power Dissipation	PT	85	mW
Operating Temperature	TA	-40 ~ +70	°C
Storage Temperature	Tstg	-40 ~ +85	
Lead Solder Temperature [2mm Below Package Base]	260°C For 3 Seconds		
Lead Solder Temperature [5mm Below Package Base]	260°C For 5 Seconds		

Operating Characteristics (TA=25°C)		MR (GaAlAs)	Unit
Forward Current (Typ.) (VF=5V)	IF	13	mA
Forward Current (Max.) (VF=5V)	IF	17.5	mA
Reverse Current (Max.) (VR=5V)	IR	10	uA
Wavelength Of Peak Emis- sion (Typ.) (VF=5V)	λ P	660	nm
Spectral Line Full Width At Half-Maximum (Typ.) (VF=5V)	λ D	640	nm
Spectral Line Half-Width (VF=5V) (Typ.)	Δλ	20	nm

Part Number	Emitting Color	Emitting Material	Lens-color	Luminous Intensity (V =5V) mcd		Wavelength nm λ P	Viewing Angle 2 θ 1/2
				min.	typ.		
XNF4ZMR46D5V	Red	GaAlAs	Red Diffused	40	148	660	40°

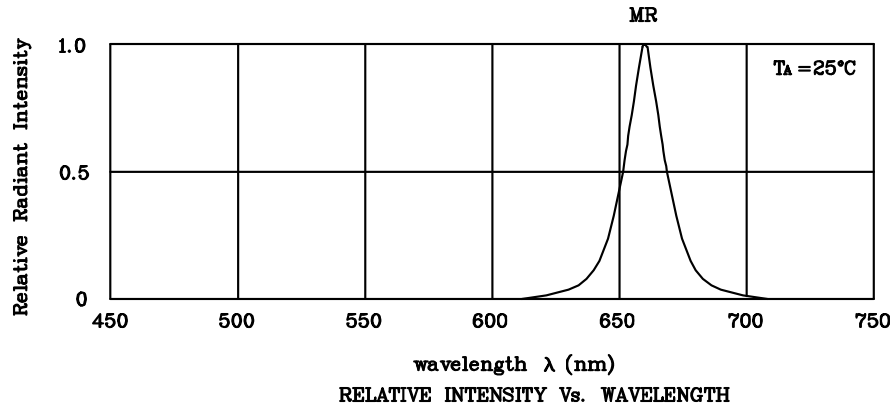

❖ MR

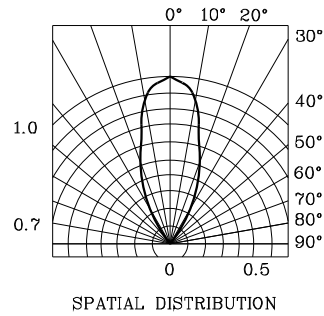
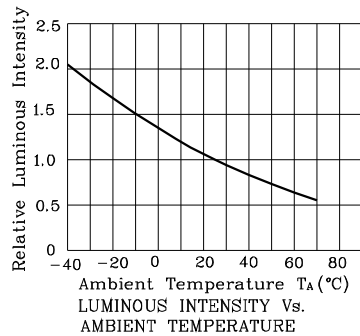
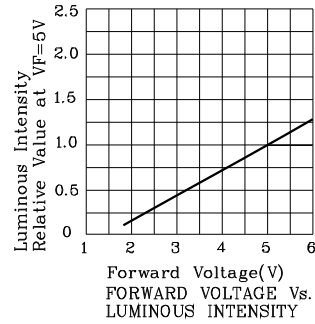
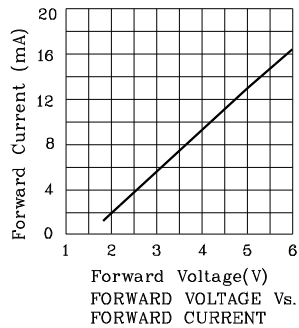

Wave Soldering Profile For Lead-free Through-hole LED.

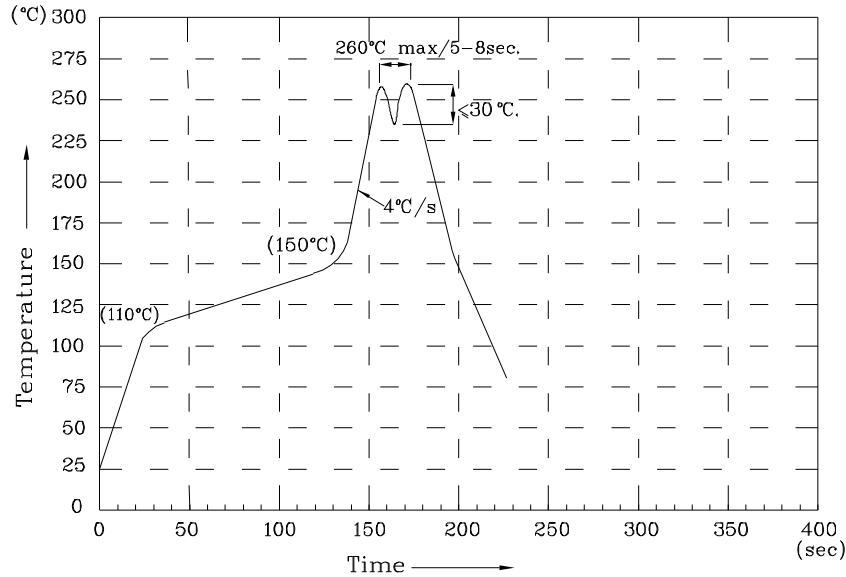

NOTES:

- 1.Recommend the wave temperature 245°C~260°C.The maximum soldering temperature should be less than 260°C.
- 2.Do not apply stress on epoxy resins when temperature is over 85 degree°C.
- 3.The soldering profile apply to the lead free soldering (Sn/Cu/Ag alloy).
- 4.No more than once.

Remarks:

If special sorting is required (e.g. binning based on luminous intensity / luminous flux or wavelength), the typical accuracy of the sorting process is as follows:

1. Wavelength: +/-1nm
2. Luminous Intensity / Luminous Flux: +/-15%

Note: Accuracy may depend on the sorting parameters.

PACKING & LABEL SPECIFICATIONS

XNF4ZMR46D5V

