

Features

- Housing material: Type 66 Nylon
- Black casing provides superior contrast
- Housing UL rating: 94V-0
- Reliable & robust
- RoHS Compliant

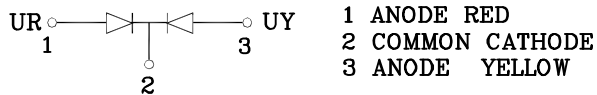

Package Schematics

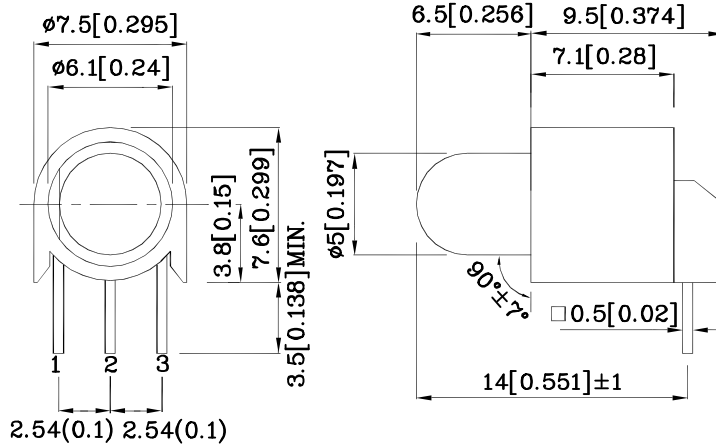

- Notes:
1. All dimensions are in millimeters (inches).
 2. Tolerance is ± 0.25 (0.01") unless otherwise noted.
 3. Specifications are subject to change without notice.

Absolute Maximum Ratings (T _A =25°C)		UR (GaAsP/ GaP)	UY (GaAsP/ GaP)	Unit
Reverse Voltage	V _R	5	5	V
Forward Current	I _F	30	30	mA
Forward Current (Peak) 1/10 Duty Cycle 0.1ms Pulse Width	i _{FS}	160	140	mA
Power Dissipation	P _D	75	75	mW
Operating Temperature	T _A	-40 ~ +85		°C
Storage Temperature	T _{stg}	-40 ~ +85		
Lead Solder Temperature [2mm Below Package Base]	260°C For 3 Seconds			
Lead Solder Temperature [5mm Below Package Base]	260°C For 5 Seconds			

Operating Characteristics (T _A =25°C)		UR (GaAsP/ GaP)	UY (GaAsP/ GaP)	Unit
Forward Voltage (Typ.) (I _F =20mA)	V _F	2	2.1	V
Forward Voltage (Max.) (I _F =20mA)	V _F	2.5	2.5	V
Reverse Current (Max.) (V _R =5V)	I _R	10	10	uA
Wavelength of Peak Emission CIE127-2007*(Typ.) (I _F =20mA)	λ _P	627 627*	590 590*	nm
Wavelength of Dominant Emission CIE127-2007*(Typ.) (I _F =20mA)	λ _D	625 617*	588 588*	nm
Spectral Line Full Width At Half-Maximum (Typ.) (I _F =20mA)	Δλ	45	35	nm
Capacitance (Typ.) (V _F =0V, f=1MHz)	C	15	20	pF

Part Number	Emitting Color	Emitting Material	Lens-color	Luminous Intensity CIE127-2007* (I _F =20mA) mcd		Wavelength CIE127-2007* nm	Viewing Angle 2θ 1/2
				min.	typ.	λ _P	
XVB1LUYR59M	Red	GaAsP/GaP	White Diffused	30	59	627	60°
	Yellow	GaAsP/GaP		20*	40*	627*	
				20	39	590	
				20*	40*	590*	

*Luminous intensity value and wavelength are in accordance with CIE127-2007 standards.

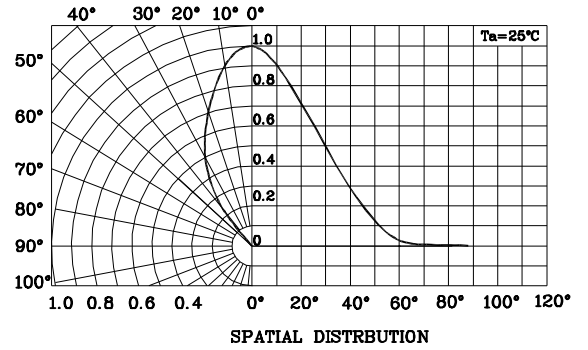
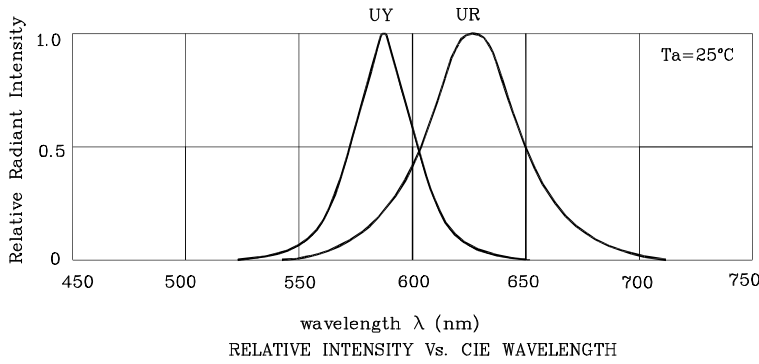

❖ UR

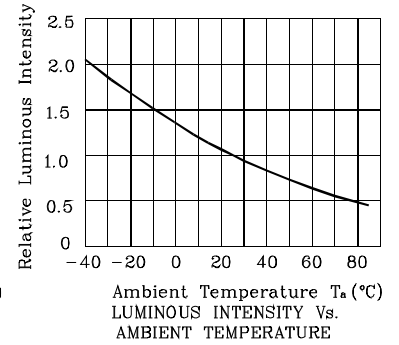
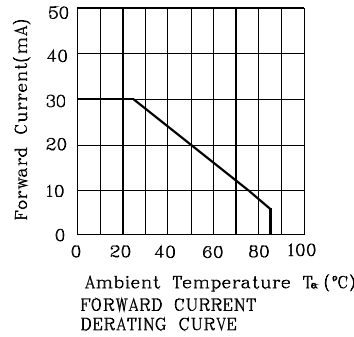
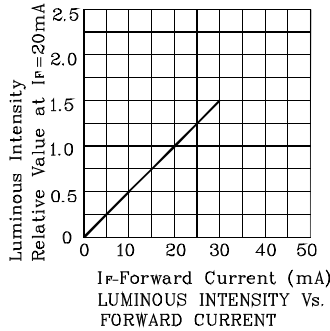
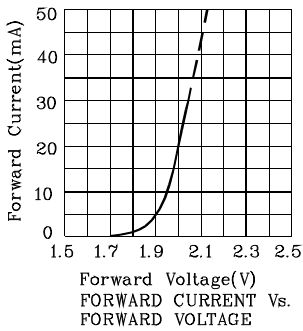

❖ UY

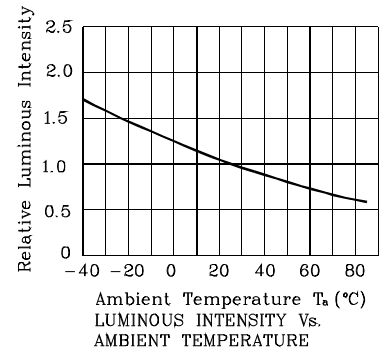
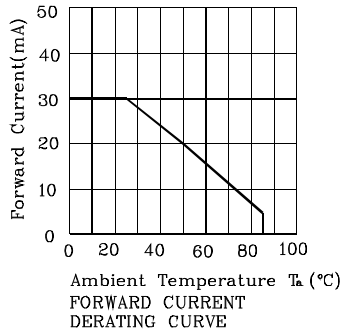
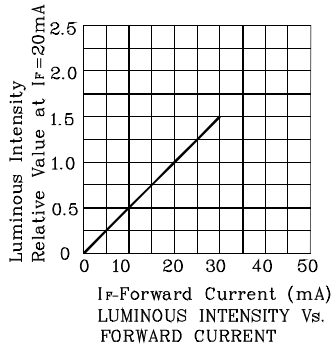
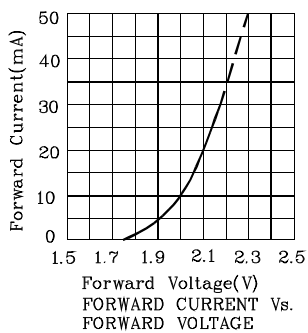

Wave Soldering Profile For Thru-Hole Products (Pb-Free Components)

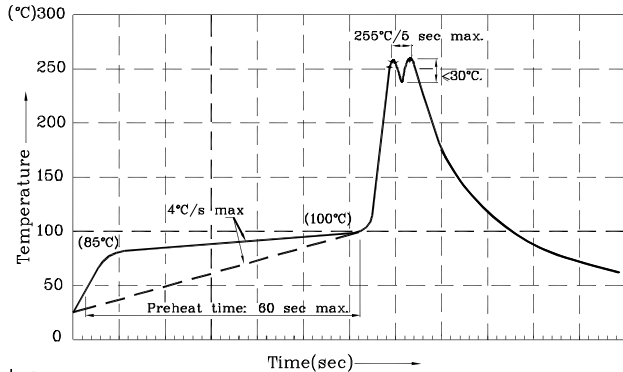

- Notes:
1. Recommend pre-heat temperature of 105°C or less (as measured with a thermocouple attached to the LED pins) prior to immersion in the solder wave with a maximum solder bath temperature of 260°C
 2. Peak wave soldering temperature between 245°C ~ 255°C for 3 sec (5 sec max).
 3. Do not apply stress to the epoxy resin while the temperature is above 85°C.
 4. Fixtures should not incur stress on the component when mounting and during soldering process.
 5. SAC 305 solder alloy is recommended.
 6. No more than one wave soldering pass.



Remarks:



If special sorting is required (e.g. binning based on forward voltage, luminous intensity / luminous flux, or wavelength), the typical accuracy of the sorting process is as follows:

1. Wavelength: +/-1nm
2. Luminous Intensity / Luminous Flux: +/-15%
3. Forward Voltage: +/-0.1V

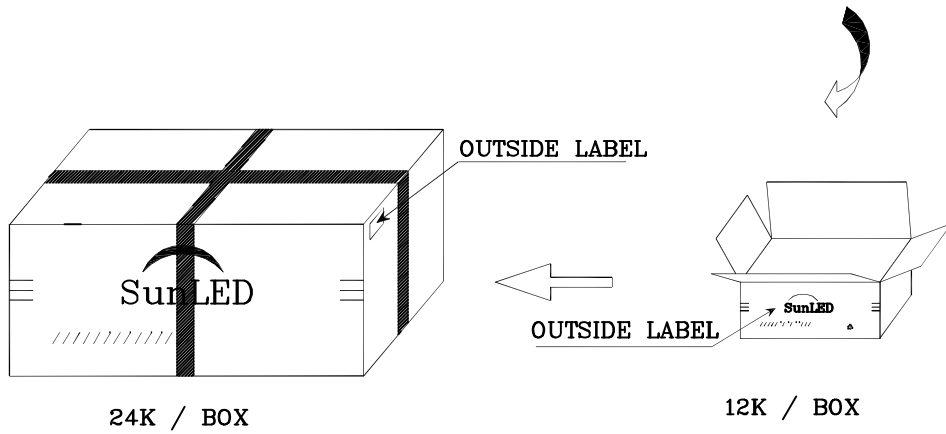
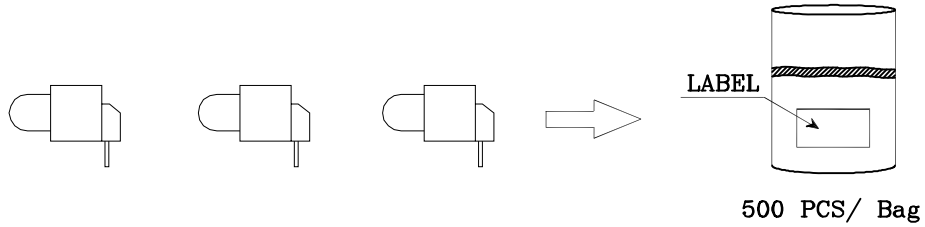
Note: Accuracy may depend on the sorting parameters.

PACKING & LABEL SPECIFICATIONS

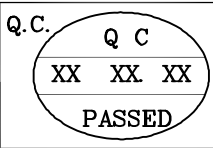
	
P/NO : XVB1Lxx59x	
QTY : 500 pcs	CODE: XXX
S/N : XX	
LOT NO:	
 xxxxxxxxxxxxxxxxxxxxxxxxxxxx	
RoHS Compliant	