

**Features**

- Long life and robust package
- Standard Package: 2,000pcs/ Reel
- MSL (Moisture Sensitivity Level): 3
- RoHS compliant

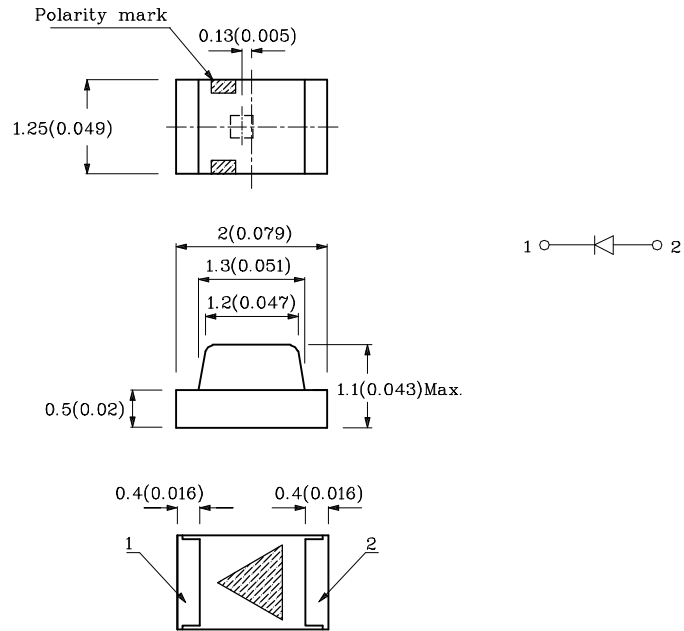

**Package Schematics**



**Notes:**

1. All dimensions are in millimeters (inches).
2. Tolerance is  $\pm 0.1(0.004)$ " unless otherwise noted.
3. Specifications are subject to change without notice.

Absolute Maximum Ratings ( $T_A=25^\circ\text{C}$ )		TNI (GaAs)	Unit
Reverse Voltage	$V_R$	5	V
Forward Current	$I_F$	50	mA
Forward Current (Peak) 1/100 Duty Cycle 10us Pulse Width	$i_{FS}$	1200	mA
Power Dissipation	$P_D$	90	mW
Operating Temperature	$T_A$	-40 ~ +85	°C
Storage Temperature	$T_{stg}$	-40 ~ +85	

A Relative Humidity between 40% and 60% is recommended in ESD-protected work areas to reduce static build up during assembly process (Reference JEDEC/JESD625-A and JEDEC/J-STD-033)

Operating Characteristics ( $T_A=25^\circ\text{C}$ )		TNI (GaAs)	Unit
Forward Voltage (Typ.) ( $I_F=20\text{mA}$ )	$V_F$	1.2	V
Forward Voltage (Max.) ( $I_F=20\text{mA}$ )	$V_F$	1.6	V
Reverse Current (Max.) ( $V_R=5\text{V}$ )	$I_R$	10	$\mu\text{A}$
Wavelength of Peak Emission CIE127-2007*(Typ.) ( $I_F=20\text{mA}$ )	$\lambda_P$	940*	nm
Spectral Line Full Width At Half-Maximum (Typ.) ( $I_F=20\text{mA}$ )	$\Delta\lambda$	50	nm
Capacitance (Typ.) ( $V_F=0\text{V}$ , $f=1\text{MHz}$ )	C	90	pF

Part Number	Emitting Material	Lens-color	Radiant Intensity CIE127-2007* ( $P_0=\text{mW/sr}$ ) @20mA		Wavelength CIE127-2007* nm $\lambda_P$	Viewing Angle 20 1/2
			min.	typ.		
XZTNI54W	GaAs	Water Clear	0.8*	2.8 1.8*	940*	160°

\*Radiant Intensity value and wavelength are in accordance with CIE127-2007 standards.

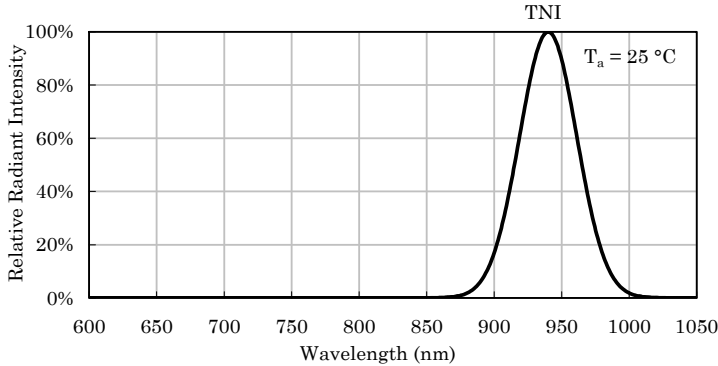

Relative Intensity Vs. CIE Wavelength

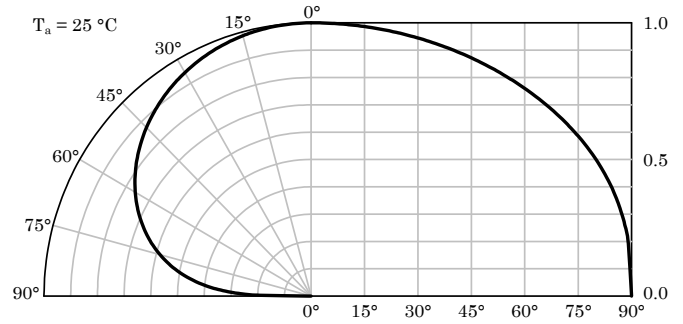

Spatial Distribution

❖ TNI

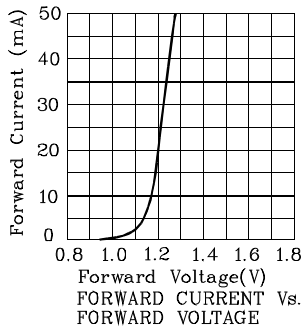

FORWARD CURRENT Vs. FORWARD VOLTAGE

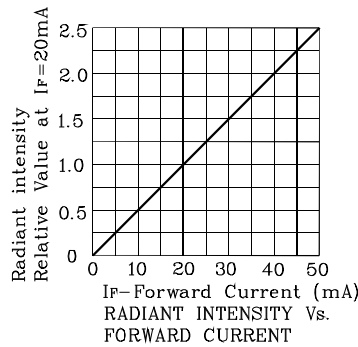

RADIANT INTENSITY Vs. FORWARD CURRENT

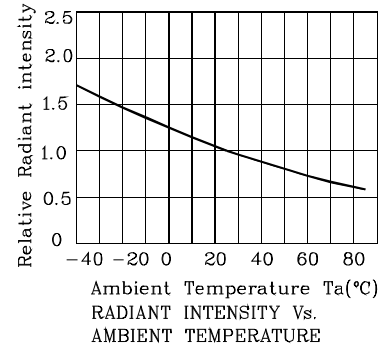

RADIANT INTENSITY Vs. AMBIENT TEMPERATURE

**LED is recommended for reflow soldering and soldering profile is shown below.**

Reflow Soldering Profile for SMD Products (Pb-Free Components)

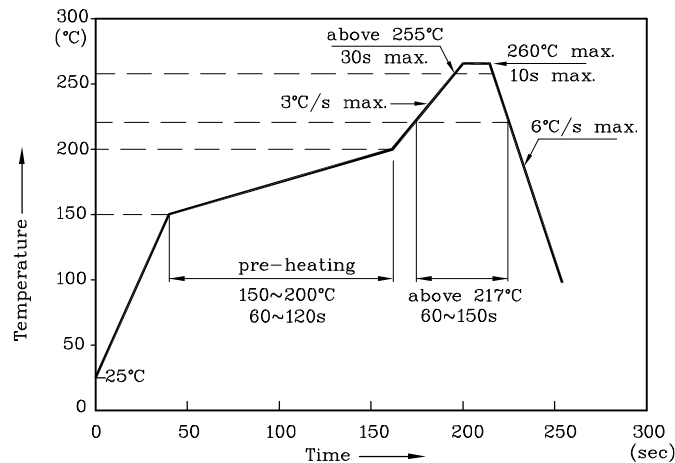

Notes:

1. All temperatures refer to the center of the package, measured on the package body surface facing up during reflow.
2. Do not apply any stress to the LED during high temperature conditions.
3. Maximum number of soldering passes: 2

❖ The device has a single mounting surface.  
The device must be mounted according to the specifications.

❖ Recommended Soldering Pattern  
(Units : mm; Tolerance: ± 0.1)

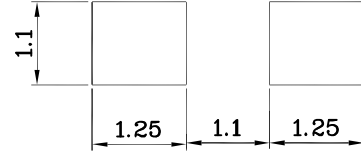
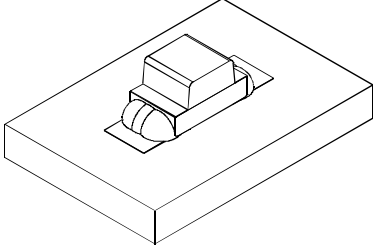

❖ Reel Dimension

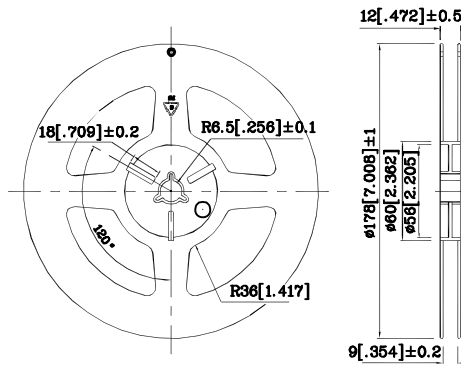

❖ Tape Specification (Units : mm)

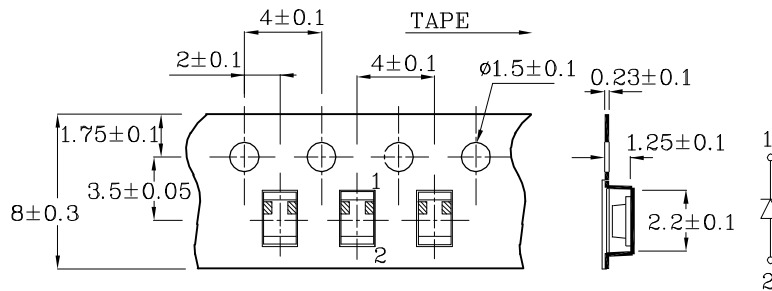

Remarks:

If special sorting is required (e.g. binning based on forward voltage or radiant intensity / luminous flux), the typical accuracy of the sorting process is as follows:

1. Radiant Intensity / Luminous Flux: +/-15%
2. Forward Voltage: +/-0.1V

Note: Accuracy may depend on the sorting parameters



**PACKING & LABEL SPECIFICATIONS**

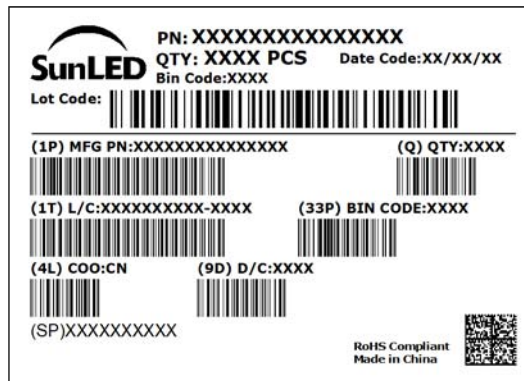
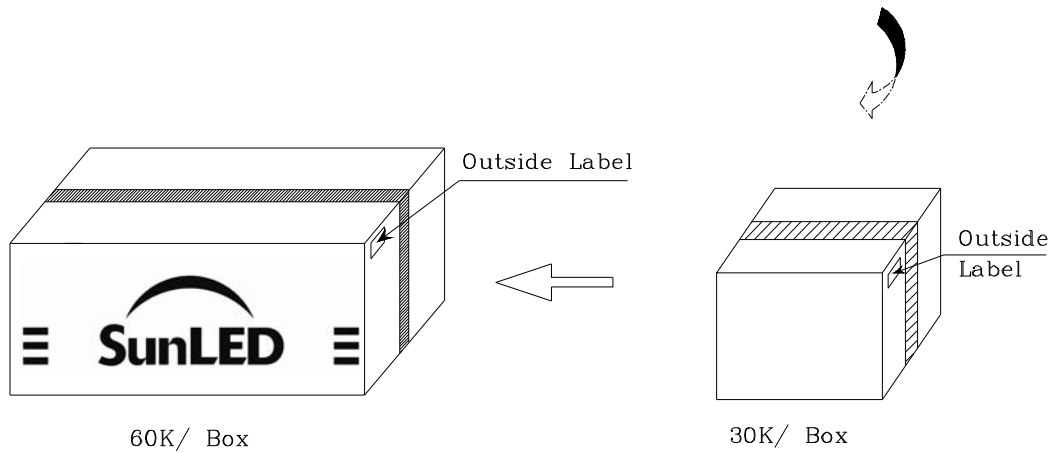
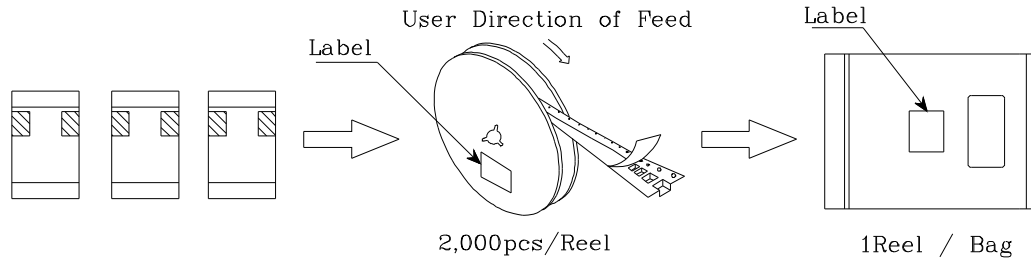

**TERMS OF USE**

1. Data presented in this document reflect statistical figures and should be treated as technical reference only.
2. Contents within this document are subject to improvement and enhancement changes without notice.
3. The product(s) in this document are designed to be operated within the electrical and environmental specifications indicated on the datasheet.  
User accepts full risk and responsibility when operating the product(s) beyond their intended specifications.
4. The product(s) described in this document are intended for electronic applications in which a person's life is not reliant upon the LED. Please consult with a SunLED representative for special applications where the LED may have a direct impact on a person's life.
5. The contents within this document may not be altered without prior consent by SunLED.
6. Additional technical notes are available at <https://www.SunLEDusa.com/TechnicalNotes.asp>