

Features

- 2.0 mm x 1.25 mm x 0.75 mm SMD LED
- Low power consumption
- Wide viewing angle
- Standard Package: 2,000pcs / Reel
- MSL (Moisture Sensitivity Level): 1
- RoHS compliant



ATTENTION
OBSERVE PRECAUTIONS
FOR HANDLING
ELECTROSTATIC
DISCHARGE
SENSITIVE
DEVICES



Package Schematics

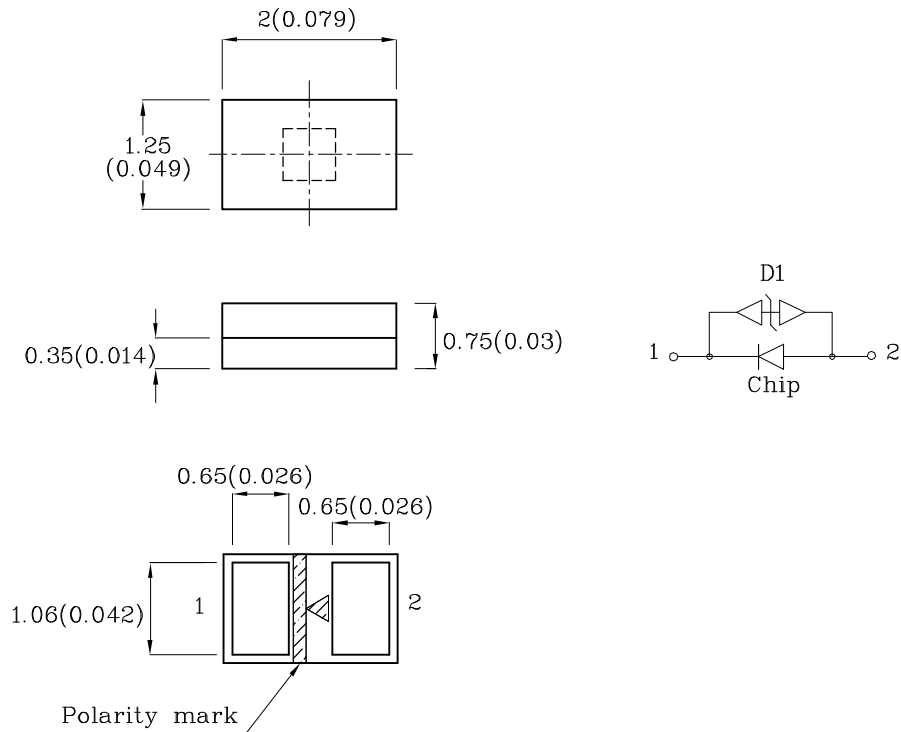

Notes:

1. All dimensions are in millimeters (inches).
2. Tolerance is $\pm 0.25(0.01)$ " unless otherwise noted.
3. Specifications are subject to change without notice.

Handling Precautions

Compare to epoxy encapsulant that is hard and brittle, silicone is softer and flexible. Although its characteristic significantly reduces thermal stress, it is more susceptible to damage by external mechanical force.

As a result, special handling precautions need to be observed during assembly using silicone encapsulated LED products. Failure to comply might lead to damage and premature failure of the LED.

1. Handle the component along the side surfaces by using forceps or appropriate tools.

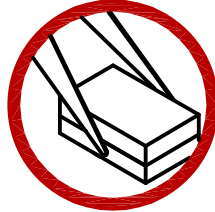

2. Do not directly touch or handle the silicone lens surface. It may damage the internal circuitry.

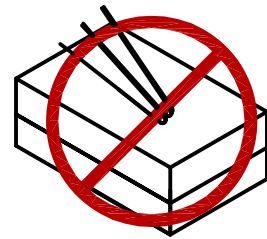
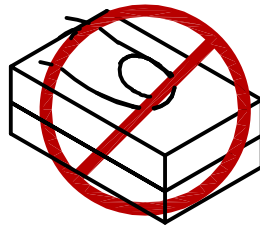

3. Do not stack together assembled PCBs containing exposed LEDs. Impact may scratch the silicone lens or damage the internal circuitry.

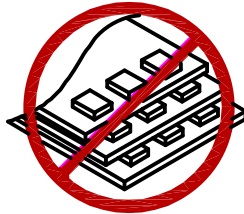

4. As silicone encapsulation is permeable to gases, some corrosive substances such as H₂S might corrode silver plating of leadframe. Special care should be taken if an LED with silicone encapsulation is to be used near such substances.

Part Number	Emitting Color (Material)	Lens-color	Radiant Flux CIE127-2007* (I _F =20mA) Φ _e =mW [2]		Viewing Angle 2θ 1/2[1]
			min.	typ.	
XZVS54S-9C	Ultraviolet (InGaN)	Water Clear	10*	15*	150°

Notes:

1. θ1/2 is the angle from optical centerline where the luminous intensity is 1/2 of the optical peak value.

2. Radiant flux: +/-15%.

*Radiant flux is in accordance with CIE127-2007 standards.

Electrical / Optical Characteristics at T_A=25°C

Parameter	Symbol	Value	Unit
Wavelength at Peak Emission I _F = 20mA [Min.]	λ _{peak}	380*	nm
Wavelength at Peak Emission I _F = 20mA [Typ.]		385*	
Wavelength at Peak Emission I _F = 20mA [Max.]		390*	
Spectral Bandwidth at 50% Φ REL MAX I _F = 20mA [Typ.]	Δλ	12	nm
Forward Voltage I _F = 20mA [Typ.]	V _F [1]	3.3	V
Forward Voltage I _F = 20mA [Max.]		3.8	
Reverse Current (V _R = 5V) [Max.]	I _R	50	μA
Temperature Coefficient of V _F I _F = 20mA, -10°C ≤ T ≤ 85°C	TC _V	-3.0	mV/°C

Notes:

1. Forward voltage: ±0.1V.

* wavelength is in accordance with CIE127-2007 standards.

Absolute Maximum Ratings at T_A=25°C

Parameter	Symbol	Value	Unit
Power Dissipation	P _D	120	mW
Reverse Voltage	V _R	5	V
Junction Temperature	T _j	115	°C
Operating Temperature	T _{op}	-40 to +85	°C
Storage Temperature	T _{stg}	-40 to +85	°C
DC Forward Current	I _F	30	mA
Peak Forward Current	I _{FM} [2]	100	mA
Thermal Resistance (Junction / Ambient)	R _{th j-a} [1]	100	°C/W
Thermal Resistance (Junction / Solder point)	R _{th j-s} [1]	50	°C/W

Notes:

1. R_{th j-a}, R_{th j-s} Results from mounting on PC board FR4 (pad size ≥ 16 mm² per pad).

2. 1/10 Duty Cycle, 0.1ms Pulse Width.

3. A Relative Humidity between 40% and 60% is recommended in ESD-protected work areas to reduce static build up during assembly process (Reference JEDEC/ JESD625-A and JEDEC/J-STD-033)

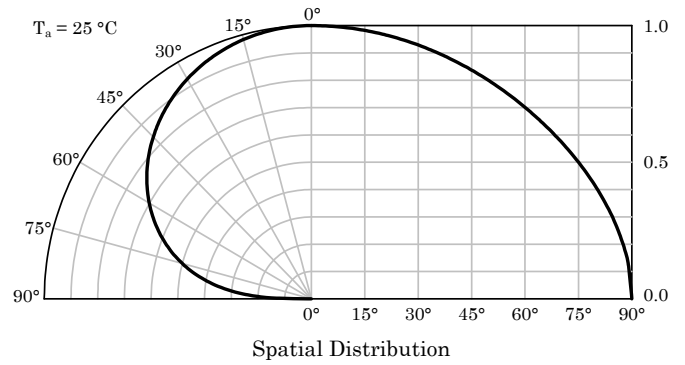
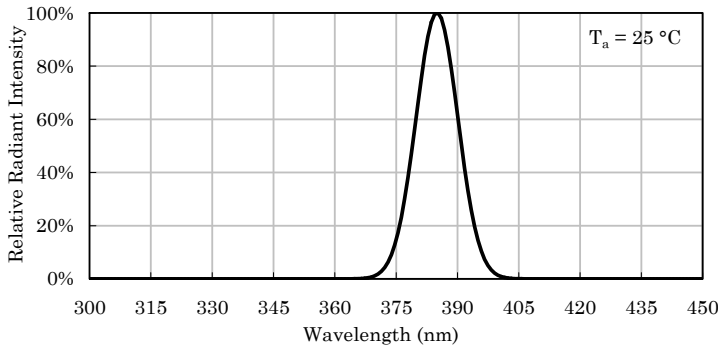

❖ **Ultraviolet**

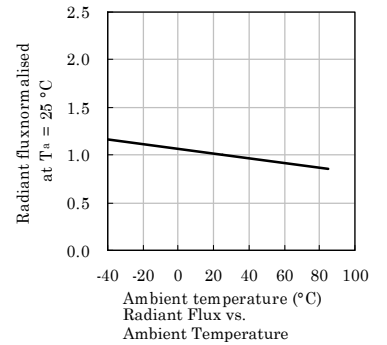
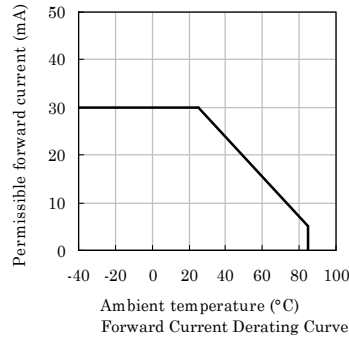
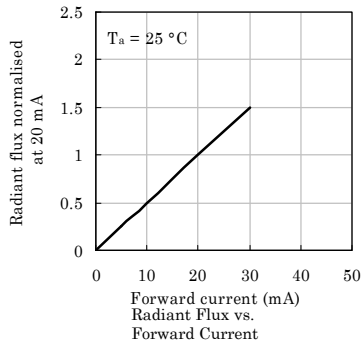
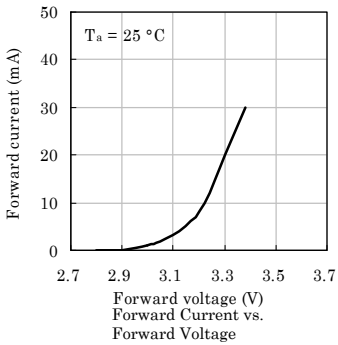

LED is recommended for reflow soldering and soldering profile is shown below.

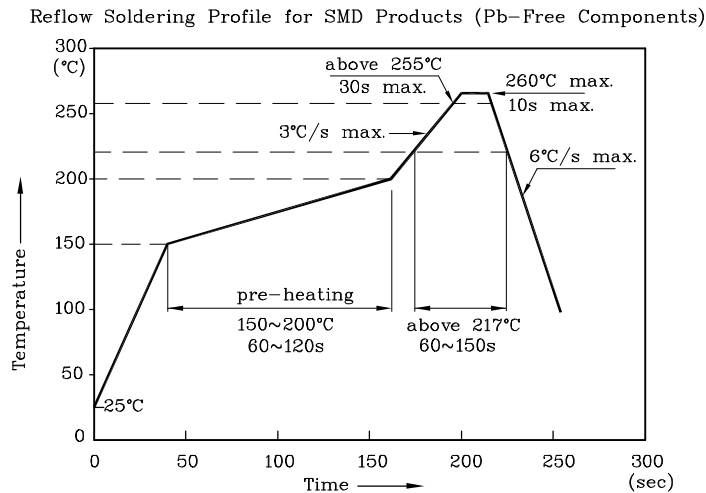

- Notes:
1. All temperatures refer to the center of the package, measured on the package body surface facing up during reflow.
 2. Do not apply any stress to the LED during high temperature conditions.
 3. Maximum number of soldering passes: 2



❖ The device has a single mounting surface.
The device must be mounted according to the specifications.

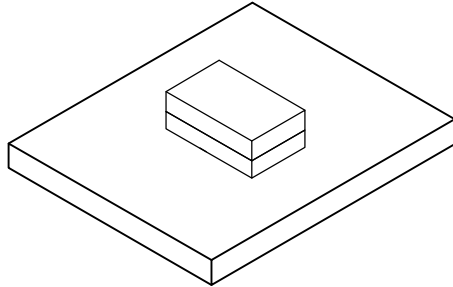

❖ Recommended Soldering Pattern
(Units : mm; Tolerance: ± 0.1)

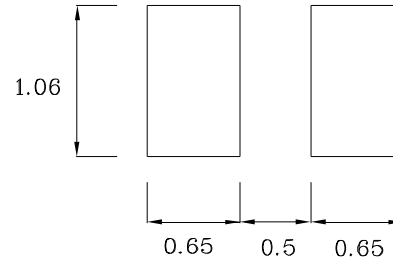

❖ Reel Dimension

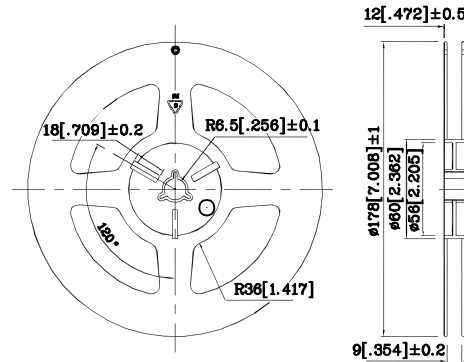

❖ Tape Specification (Units : mm)

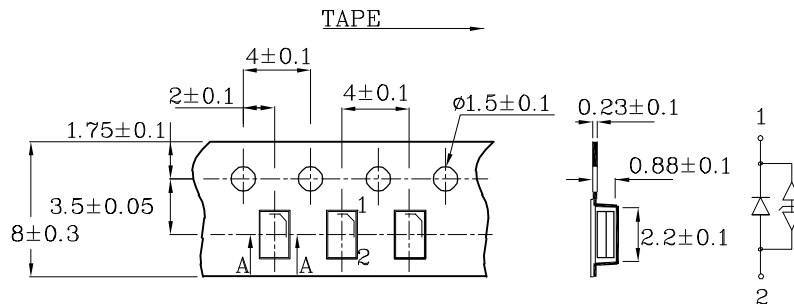

Remarks:

If special sorting is required (e.g. binning based on forward voltage, Luminous intensity / luminous flux, or wavelength), the typical accuracy of the sorting process is as follows:

1. Wavelength: +/-1nm
2. Luminous intensity / luminous flux: +/-15%
3. Forward Voltage: +/-0.1V

Note: Accuracy may depend on the sorting parameters.

PACKING & LABEL SPECIFICATIONS

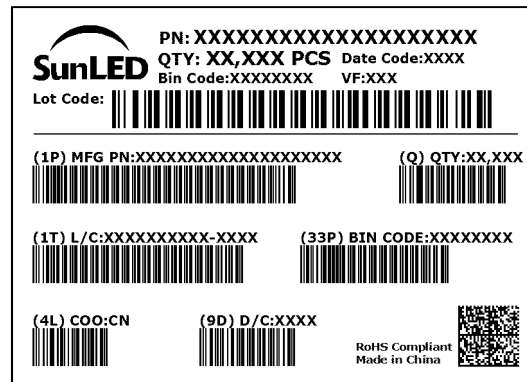
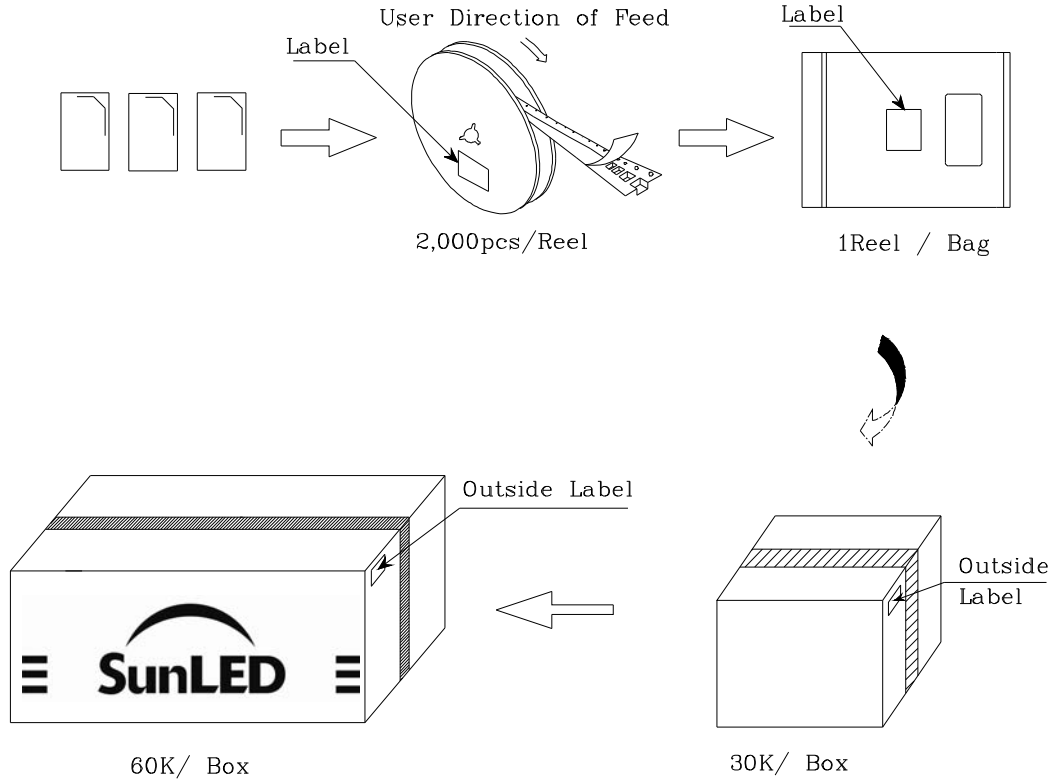

TERMS OF USE

1. Data presented in this document reflect statistical figures and should be treated as technical reference only.
2. Contents within this document are subject to improvement and enhancement changes without notice.
3. The product(s) in this document are designed to be operated within the electrical and environmental specifications indicated on the datasheet. User accepts full risk and responsibility when operating the product(s) beyond their intended specifications.
4. The product(s) described in this document are intended for electronic applications in which a person's life is not reliant upon the LED. Please consult with a SunLED representative for special applications where the LED may have a direct impact on a person's life.
5. The contents within this document may not be altered without prior consent by SunLED.
6. Additional technical notes are available at <http://www.SunLEDusa.com/TechnicalNotes.asp>