

■ Notice for TAIYO YUDEN products

Please read this notice before using the TAIYO YUDEN products.

⚠ REMINDERS

- Product information in this catalog is as of October 2015. All of the contents specified herein are subject to change without notice due to technical improvements, etc. Therefore, please check for the latest information carefully before practical application or usage of the Products.

Please note that TAIYO YUDEN CO., LTD. shall not be responsible for any defects in products or equipment incorporating such products, which are caused under the conditions other than those specified in this catalog or individual specification.

- Please contact TAIYO YUDEN CO., LTD. for further details of product specifications as the individual specification is available.

- Please conduct validation and verification of products in actual condition of mounting and operating environment before commercial shipment of the equipment.

- All electronic components listed in this catalogue are intended for use in general electronic equipment such as AV/OA equipment, home electrical appliances, office equipment, information-communication equipment, general medical equipment, industrial equipment, and automotive applications.

Please be sure to contact TAIYO YUDEN CO., LTD. for further information before using the components for any equipment which might have a negative impact directly on human life, such as specially controlled medical equipment, transportation equipment (automotive powertrain/train/ship control systems, etc.) and traffic signal system.

Please do not incorporate the components into any equipment requiring a high degree of safety and reliability, such as aerospace equipment, avionics, nuclear control equipment, submarine system, and military equipment.

For use in high safety and reliability-required devices/circuits of general electronic equipment, thorough safety evaluation prior to use is strongly recommended, and a protective circuit should be designed and installed as necessary.

- The contents of this catalog are applicable to the products which are purchased from our sales offices or distributors (so called "TAIYO YUDEN's official sales channel").

It is only applicable to the products purchased from any of TAIYO YUDEN's official sales channel.

- Please note that TAIYO YUDEN CO., LTD. shall have no responsibility for any controversies or disputes that may occur in connection with a third party's intellectual property rights and other related rights arising from your usage of products in this catalog. TAIYO YUDEN CO., LTD. grants no license for such rights.

- Caution for export

Certain items in this catalog may require specific procedures for export according to "Foreign Exchange and Foreign Trade Control Law" of Japan, "U.S. Export Administration Regulations", and other applicable regulations. Should you have any question or inquiry on this matter, please contact our sales staff.

MULTILAYER CERAMIC CAPACITORS



REFLOW

AEC-200

PART NUMBER

J	M	K	3	1	6	△	B	J	1	0	6	M	L	H	T	△
①	②	③	④	⑤	⑥	⑦	⑧	⑨	⑩	⑪	⑫					

△ = Blank space

① Rated voltage

Code	Rated voltage [VDC]
A	4
J	6.3
L	10
E	16
T	25
G	35
U	50
H	100
Q	250
S	630

② Series name

Code	Series name
M	Multilayer ceramic capacitor
V	Multilayer ceramic capacitor for high frequency
W	LW reverse type multilayer capacitor

③ End termination

Code	End termination
K	Plated
J	Soft Termination
S	Cu Internal Electrodes
R	High Reliability Application

④ Dimension (L × W)

Type	Dimensions (L × W) [mm]	EIA (inch)
063	0.6 × 0.3	0201
105	1.0 × 0.5	0402
	0.52 × 1.0 ※	0204
107	1.6 × 0.8	0603
	0.8 × 1.6 ※	0306
212	2.0 × 1.25	0805
	1.25 × 2.0 ※	0508
316	3.2 × 1.6	1206
325	3.2 × 2.5	1210
432	4.5 × 3.2	1812

Note : ※LW reverse type (□WK) only

⑤ Dimension tolerance

Code	Type	L [mm]	W [mm]	T [mm]
△	ALL	Standard	Standard	Standard
A	063	0.6±0.05	0.3±0.05	0.3±0.05
	105	1.0±0.10	0.5±0.10	0.5±0.10
	107	1.6+0.15/-0.05	0.8+0.15/-0.05	0.8+0.15/-0.05
	212	2.0+0.15/-0.05	1.25+0.15/-0.05	0.85±0.10 1.25+0.15/-0.05
	316	3.2±0.20	1.6±0.20	1.6±0.20
	325	3.2±0.30	2.5±0.30	2.5±0.30
B	105	1.0+0.15/-0.05	0.5+0.15/-0.05	0.5+0.15/-0.05
	107	1.6+0.20/-0	0.8+0.20/-0	0.8+0.20/-0
	212	2.0+0.20/-0	1.25+0.20/-0	0.85±0.10 1.25+0.20/-0
316	3.2±0.30	1.6±0.30	1.6±0.30	
C	105	1.0+0.20/-0	0.5+0.20/-0	0.5+0.20/-0
	107	1.6+0.25/-0	0.8+0.25/-0	0.8+0.25/-0
	212	2.0+0.25/-0	1.25+0.25/-0	1.25+0.25/-0
K	212	2.0±0.15	1.25±0.15	0.85±0.15
	316	3.2±0.20	1.6±0.20	1.15±0.20 1.6±0.20
	325	3.2±0.50	2.5±0.30	2.5±0.30

Note: P.22 Standard external dimensions

△ = Blank space

⑥ Temperature characteristics code

■ High dielectric type

Code	Applicable standard	Temperature range [°C]	Ref. Temp. [°C]	Capacitance change	Capacitance tolerance	Tolerance code
BJ	EIA	X5R	-55~+85	25	±15%	±10%
						±20%
B7	EIA	X7R	-55~+125	25	±15%	±10%
						±20%
C6	EIA	X6S	-55~+105	25	±22%	±10%
						±20%
C7	EIA	X7S	-55~+125	25	±22%	±10%
						±20%
D7	EIA	X7T	-55~+125	25	+22%/-33%	±10%
						±20%

▶ This catalog contains the typical specification only due to the limitation of space. When you consider the purchase of our products, please check our specification. For details of each product (characteristics graph, reliability information, precautions for use, and so on), see our Web site (<http://www.ty-top.com/>).

■ Temperature compensating type

Code	Applicable standard		Temperature range [°C]	Ref. Temp. [°C]	Capacitance change	Capacitance tolerance	Tolerance code
CG	JIS	CG	-55 ~ +125	20	0 ± 30 ppm/°C	± 0.1 pF	B
						± 0.25 pF	C
	± 0.5 pF	D					
	EIA	COG		25		± 1 pF	F
						± 2%	G
						± 5%	J

⑦ Nominal capacitance

Code (example)	Nominal capacitance
0R5	0.5 pF
010	1 pF
100	10 pF
101	100 pF
102	1,000 pF
103	0.01 μ F
104	0.1 μ F
105	1.0 μ F
106	10 μ F
107	100 μ F

Note : R=Decimal point

⑧ Capacitance tolerance

Code	Capacitance tolerance
B	± 0.1 pF
C	± 0.25 pF
D	± 0.5 pF
G	± 2%
J	± 5%
K	± 10%
M	± 20%

⑨ Thickness

Code	Thickness [mm]
P	0.3
T	
V	0.5
C	0.7 (107 type or more)
A	0.8
D	0.85 (212 type or more)
F	1.15
G	1.25
H	1.5
L	1.6
N	1.9
M	2.5

⑩ Special code

Code	Special code
H	MLCC for Industrial and Automotive

⑪ Packaging

Code	Packaging
F	φ 178mm Taping (2mm pitch)
R	φ 178mm Embossed Taping (4mm pitch)
T	φ 178mm Taping (4mm pitch)
P	φ 178mm Taping (4mm pitch, 1000 pcs/reel) 325 type (Thickness code M)

⑫ Internal code

Code	Internal code
△	Standard

STANDARD EXTERNAL DIMENSIONS

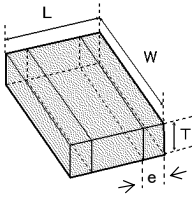
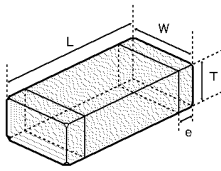

※ LW reverse type

Type(EIA)	Dimension [mm] (inch)				
	L	W	T	*1	e
□MK063(0201)	0.6±0.03 (0.024±0.001)	0.3±0.03 (0.012±0.001)	0.3±0.03 (0.012±0.001)	T	0.15±0.05 (0.006±0.002)
□MK105(0402)	1.0±0.05 (0.039±0.002)	0.5±0.05 (0.020±0.002)	0.5±0.05 (0.020±0.002)	V	0.25±0.10 (0.010±0.004)
□WK105(0204)※	0.52±0.05 (0.020±0.002)	1.0±0.05 (0.039±0.002)	0.3±0.05 (0.012±0.002)	P	0.18±0.08 (0.007±0.003)
□MK107(0603)	1.6±0.10 (0.063±0.004)	0.8±0.10 (0.031±0.004)	0.8±0.10 (0.031±0.004)	A	0.35±0.25 (0.014±0.010)
□MJ107(0603)	1.6±0.10 (0.063±0.004)	0.8±0.10 (0.031±0.004)	0.8±0.10 (0.031±0.004)	A	0.35±0.25 (0.014±0.010)
□VS107(0603)	1.6±0.10 (0.063±0.004)	0.8±0.10 (0.031±0.004)	0.7±0.10 (0.031±0.004)	C	0.35±0.25 (0.014±0.010)
□MR107(0603)	1.6±0.10 (0.063±0.004)	0.8±0.10 (0.031±0.004)	0.8±0.10 (0.031±0.004)	A	0.1~0.6 (0.004~0.024)
□WK107(0306)※	0.8±0.10 (0.031±0.004)	1.6±0.10 (0.063±0.004)	0.5±0.05 (0.020±0.002)	V	0.25±0.15 (0.010±0.006)
□MK212(0805)	2.0±0.10 (0.079±0.004)	1.25±0.10 (0.049±0.004)	0.85±0.10 (0.033±0.004)	D	0.5±0.25 (0.020±0.010)
			1.25±0.10 (0.049±0.004)	G	
□MJ212(0805)	2.0±0.10 (0.079±0.004)	1.25±0.10 (0.049±0.004)	0.85±0.10 (0.033±0.004)	D	0.5±0.25 (0.020±0.010)
			1.25±0.10 (0.049±0.004)	G	
□VS212(0805)	2.0±0.10 (0.079±0.004)	1.25±0.10 (0.049±0.004)	0.85±0.10 (0.033±0.004)	D	0.5±0.25 (0.020±0.010)
□MR212(0805)	2.0±0.10 (0.079±0.004)	1.25±0.10 (0.049±0.004)	1.25±0.10 (0.049±0.004)	G	0.25~0.75 (0.010~0.029)
□WK212(0508)※	1.25±0.15 (0.049±0.006)	2.0±0.15 (0.079±0.006)	0.85±0.10 (0.033±0.004)	D	0.3±0.2 (0.012±0.008)
□MK316(1206)	3.2±0.15 (0.126±0.006)	1.6±0.15 (0.063±0.006)	1.15±0.10 (0.045±0.004)	F	0.5+0.35/-0.25 (0.020+0.014/-0.010)
			1.6±0.20 (0.063±0.008)	L	
□MJ316(1206)	3.2±0.15 (0.126±0.006)	1.6±0.15 (0.063±0.006)	1.15±0.10 (0.045±0.004)	F	0.5+0.35/-0.25 (0.020+0.014/-0.010)
			1.6±0.20 (0.063±0.008)	L	
□MR316(1206)	3.2±0.15 (0.126±0.006)	1.6±0.15 (0.063±0.006)	1.6±0.20 (0.063±0.008)	L	0.25~0.85 (0.010~0.033)
□MK325(1210)	3.2±0.30 (0.126±0.012)	2.5±0.20 (0.098±0.008)	1.15±0.10 (0.045±0.004)	F	0.6±0.3 (0.024±0.012)
			1.5±0.10 (0.059±0.004)	H	
			1.9±0.20 (0.075±0.008)	N	
			2.5±0.20 (0.098±0.008)	M	
□MJ325(1210)	3.2±0.30 (0.126±0.012)	2.5±0.20 (0.098±0.008)	1.9±0.20 (0.075±0.008)	N	0.6±0.3 (0.024±0.012)
			2.5±0.20 (0.098±0.008)	M	
□MR325(1210)	3.2±0.30 (0.126±0.012)	2.5±0.20 (0.098±0.008)	1.9±0.20 (0.075±0.008)	N	0.3~0.9 (0.012~0.035)
			2.5±0.20 (0.098±0.008)	M	
□MK432(1812)	4.5±0.40 (0.177±0.016)	3.2±0.30 (0.126±0.012)	2.5±0.20 (0.098±0.008)	M	0.9±0.6 (0.035±0.024)

Note : ※. LW reverse type, *1.Thickness code

► This catalog contains the typical specification only due to the limitation of space. When you consider the purchase of our products, please check our specification. For details of each product (characteristics graph, reliability information, precautions for use, and so on), see our Web site (<http://www.ty-top.com/>).

■ STANDARD QUANTITY

Type	EIA (inch)	Dimension		Standard quantity [pcs]	
		[mm]	Code	Paper tape	Embossed tape
063	0201	0.3	T	15000	—
105	0402	0.5	V	10000	—
	0204 ※	0.30	P		
107	0603	0.7	C	4000	—
		0.8	A		
		0.8	A	—	4000
		0.8	A	3000 (Soft Termination)	—
	0306 ※	0.50	V	—	4000
212	0805	0.85	D	4000	—
		1.25	G	—	3000
		1.25	G	—	2000 (Soft Termination)
	0508 ※	0.85	D	4000	—
316	1206	1.15	F	—	3000
		1.6	L	—	2000
325	1210	1.15	F	—	2000
		1.5	H		
		1.9	N	—	500(T), 1000(P)
		2.5	M		
432	1812	2.5	M	—	500

Note : ※ LW Reverse type (□WK)

■ PART NUMBER

- All the Multilayer Ceramic Capacitors of Catalog Lineup are Compliance RoHS.
- Capacitance tolerance code is applied to □ of part number.
- All the Multilayer Ceramic Capacitors of Catalog Lineup are Compliance Reflow.

Note)

- Information about usage environment or condition is necessary depending on the application and circuit condition. Please contact TAIYO YUDEN sales channels.

- *1: Automotive (AEC-Q200 Qualified) products

< **AEC-Q200** : AEC-Q200 qualified >

All the Multilayer Ceramic Capacitors of *1 marks are tested based on the test conditions and methods defined in AEC-Q200 by family item.

125°C products: AEC-Q200 Grade1 (we conduct the evaluation at the test condition of Grade1.)

105°C products: AEC-Q200 Grade2 (we conduct the evaluation at the test condition of Grade2.)

85°C products: AEC-Q200 Grade3 (we conduct the evaluation at the test condition of Grade3.)

Please consult with TAIYO YUDEN's official sales channel for the details of the product specification and AEC-Q200 test results, etc.,

and please review and approve TAIYO YUDEN's product specification before ordering.

- *2: Industrial products and Medical products

- *3: For standard case size, please kindly refer to ④Dimension, ⑤Dimension tolerance, ⑨Thickness and Standard external dimensions on Page 22.

Multilayer Ceramic Capacitors (High dielectric type)

● **105TYPE (Demension:1.0×0.5mm JIS:1005 EIA:0402)**

[Temperature Characteristic BJ : X5R] 0.5mm thickness (V)

Part number 1	Part number 2	Rated voltage [V]	Temperature characteristics	Capacitance [F]	Capacitance tolerance [%]	tan δ [%]	HALT	Thickness*3 [mm]	Note
							Rated voltage x %		
UMK105 BJ102□VHF		50	X5R	1000 p	±10, ±20	2.5	200	0.5±0.05	*1,*2
UMK105 BJ152□VHF			X5R	1500 p	±10, ±20	2.5	200	0.5±0.05	*1,*2
UMK105 BJ222□VHF			X5R	2200 p	±10, ±20	2.5	200	0.5±0.05	*1,*2
UMK105 BJ332□VHF			X5R	3300 p	±10, ±20	2.5	200	0.5±0.05	*1,*2
UMK105 BJ472□VHF			X5R	4700 p	±10, ±20	2.5	200	0.5±0.05	*1,*2
UMK105 BJ682□VHF			X5R	6800 p	±10, ±20	2.5	150	0.5±0.05	*1,*2
UMK105 BJ103□VHF			X5R	0.01 μ	±10, ±20	3.5	200	0.5±0.05	*1,*2
UMK105 BJ223□VHF			X5R	0.022 μ	±10, ±20	10	150	0.5±0.05	*1,*2
UMK105 BJ473□VHF			X5R	0.047 μ	±10, ±20	10	150	0.5±0.05	*1,*2
UMK105 BJ104□VHF			X5R	0.1 μ	±10, ±20	10	150	0.5±0.05	*1,*2
TMK105 BJ472□VHF			X5R	4700 p	±10, ±20	2.5	200	0.5±0.05	*1,*2
TMK105 BJ682□VHF			X5R	6800 p	±10, ±20	2.5	200	0.5±0.05	*1,*2
TMK105 BJ103□VHF			X5R	0.01 μ	±10, ±20	3.5	200	0.5±0.05	*1,*2
TMK105 BJ223□VHF			X5R	0.022 μ	±10, ±20	3.5	200	0.5±0.05	*1,*2
TMK105 BJ473□VHF		X5R	0.047 μ	±10, ±20	3.5	150	0.5±0.05	*1,*2	
TMK105 BJ104□VHF		X5R	0.1 μ	±10, ±20	5	150	0.5±0.05	*1,*2	
TMK105 BJ224□VHF		X5R	0.22 μ	±10, ±20	10	150	0.5±0.05	*1,*2	
TMK105ABJ474□VHF		X5R	0.47 μ	±10, ±20	10	150	0.5±0.10	*1,*2	
EMK105 BJ223□VHF		X5R	0.022 μ	±10, ±20	3.5	200	0.5±0.05	*1,*2	
EMK105 BJ473□VHF		X5R	0.047 μ	±10, ±20	3.5	150	0.5±0.05	*1,*2	
EMK105 BJ104□VHF		X5R	0.1 μ	±10, ±20	5	150	0.5±0.05	*1,*2	
EMK105 BJ224□VHF		X5R	0.22 μ	±10, ±20	10	150	0.5±0.05	*1,*2	
EMK105ABJ474□VHF		X5R	0.47 μ	±10, ±20	10	150	0.5±0.10	*1,*2	
EMK105 BJ105□VHF		X5R	1 μ	±10, ±20	10	150	0.5±0.05	*1,*2	
LМК105 BJ224□VHF		X5R	0.22 μ	±10, ±20	5	150	0.5±0.05	*1,*2	
LМК105ABJ474□VHF		X5R	0.47 μ	±10, ±20	10	150	0.5±0.10	*1,*2	
LМК105 BJ105□VHF		X5R	1 μ	±10, ±20	10	150	0.5±0.05	*1,*2	
LМК105ABJ225MVHF		X5R	2.2 μ	±20	10	150	0.5±0.10	*1,*2	
JMK105 BJ224□VHF		X5R	0.22 μ	±10, ±20	5	150	0.5±0.05	*1,*2	
JMK105 BJ474□VHF		X5R	0.47 μ	±10, ±20	10	150	0.5±0.05	*1,*2	
JMK105 BJ105□VHF		X5R	1 μ	±10, ±20	10	150	0.5±0.05	*1,*2	
JMK105 BJ225MVHF		X5R	2.2 μ	±20	10	150	0.5±0.05	*1,*2	
JMK105BBJ475MVHF		X5R	4.7 μ	±20	10	150	0.5+0.15/-0.05	*1,*2	
AMK105 BJ225MVHF		X5R	2.2 μ	±20	10	150	0.5±0.05	*1,*2	
AMK105BBJ475MVHF		X5R	4.7 μ	±20	10	150	0.5+0.15/-0.05	*1,*2	
AMK105CBBJ106MVHF		X5R	10 μ	±20	10	150	0.5+0.20/-0	*1,*2	

[Temperature Characteristic B7 : X7R] 0.5mm thickness (V)

Part number 1	Part number 2	Rated voltage [V]	Temperature characteristics	Capacitance [F]	Capacitance tolerance [%]	tan δ [%]	HALT	Thickness*3 [mm]	Note
							Rated voltage x %		
UMK105 B7102□VHF		50	X7R	1000 p	±10, ±20	2.5	200	0.5±0.05	*1,*2
UMK105 B7152□VHF			X7R	1500 p	±10, ±20	2.5	200	0.5±0.05	*1,*2
UMK105 B7222□VHF			X7R	2200 p	±10, ±20	2.5	200	0.5±0.05	*1,*2
UMK105 B7332□VHF			X7R	3300 p	±10, ±20	2.5	200	0.5±0.05	*1,*2
UMK105 B7472□VHF			X7R	4700 p	±10, ±20	2.5	150	0.5±0.05	*1,*2
UMK105 B7682□VHF			X7R	6800 p	±10, ±20	2.5	150	0.5±0.05	*1,*2
UMK105 B7103□VHF			X7R	0.01 μ	±10, ±20	3.5	150	0.5±0.05	*1,*2
UMK105 B7223□VHF			X7R	0.022 μ	±10, ±20	10	150	0.5±0.05	*1,*2
UMK105 B7473□VHF			X7R	0.047 μ	±10, ±20	10	150	0.5±0.05	*1,*2
UMK105 B7104□VHF			X7R	0.1 μ	±10, ±20	10	150	0.5±0.05	*1,*2
TMK105 B7472□VHF			X7R	4700 p	±10, ±20	2.5	200	0.5±0.05	*1,*2
TMK105 B7682□VHF			X7R	6800 p	±10, ±20	2.5	200	0.5±0.05	*1,*2
TMK105 B7103□VHF			X7R	0.01 μ	±10, ±20	3.5	200	0.5±0.05	*1,*2
TMK105 B7223□VHF			X7R	0.022 μ	±10, ±20	3.5	150	0.5±0.05	*1,*2
TMK105 B7473□VHF		X7R	0.047 μ	±10, ±20	3.5	150	0.5±0.05	*1,*2	
TMK105 B7104□VHF		X7R	0.1 μ	±10, ±20	10	150	0.5±0.05	*1,*2	
EMK105 B7223□VHF		X7R	0.022 μ	±10, ±20	3.5	150	0.5±0.05	*1,*2	
EMK105 B7473□VHF		X7R	0.047 μ	±10, ±20	3.5	150	0.5±0.05	*1,*2	
EMK105 B7104□VHF		X7R	0.1 μ	±10, ±20	5	150	0.5±0.05	*1,*2	
EMK105 B7224□VHF		X7R	0.22 μ	±10, ±20	10	150	0.5±0.05	*1,*2	
LМК105 B7104□VHF		X7R	0.1 μ	±10, ±20	5	150	0.5±0.05	*1,*2	
LМК105 B7224□VHF		X7R	0.22 μ	±10, ±20	10	150	0.5±0.05	*1,*2	
JMK105 B7224□VHF		X7R	0.22 μ	±10, ±20	10	150	0.5±0.05	*1,*2	
JMK105 B7474□VHF		X7R	0.47 μ	±10, ±20	10	150	0.5±0.05	*1,*2	

▶ This catalog contains the typical specification only due to the limitation of space. When you consider the purchase of our products, please check our specification. For details of each product (characteristics graph, reliability information, precautions for use, and so on), see our Web site (<http://www.ty-top.com/>).

■ PART NUMBER

● 107TYPE (Dimension:1.6×0.8mm JIS:1608 EIA:0603)

[Temperature Characteristic BJ : X5R] 0.8mm thickness (A)

Part number 1	Part number 2	Rated voltage [V]	Temperature characteristics	Capacitance [F]	Capacitance tolerance [%]	tan δ [%]	HALT	Thickness*3 [mm]	Note
							Rated voltage x %		
UMK107 BJ104□AHT		50	X5R	0.1 μ	±10, ±20	3.5	150	0.8±0.10	*1, *2
UMK107 BJ224□AHT			X5R	0.22 μ	±10, ±20	10	150	0.8±0.10	*1, *2
UMK107 BJ474□AHT			X5R	0.47 μ	±10, ±20	10	150	0.8±0.10	*1, *2
UMK107ABJ105□AHT			X5R	1 μ	±10, ±20	10	150	0.8+0.15/-0.05	*1, *2
GMK107 BJ223□AHT		35	X5R	0.022 μ	±10, ±20	2.5	200	0.8±0.10	*1, *2
GMK107 BJ473□AHT			X5R	0.047 μ	±10, ±20	3.5	200	0.8±0.10	*1, *2
GMK107 BJ104□AHT			X5R	0.1 μ	±10, ±20	3.5	150	0.8±0.10	*1, *2
GMK107 BJ224□AHT			X5R	0.22 μ	±10, ±20	10	150	0.8±0.10	*1, *2
GMK107ABJ474□AHT		25	X5R	0.47 μ	±10, ±20	10	150	0.8+0.15/-0.05	*1, *2
GMK107 BJ105□AHT			X5R	1 μ	±10, ±20	10	150	0.8±0.10	*1, *2
TMK107 BJ223□AHT			X5R	0.022 μ	±10, ±20	2.5	200	0.8±0.10	*1, *2
TMK107 BJ473□AHT			X5R	0.047 μ	±10, ±20	3.5	200	0.8±0.10	*1, *2
TMK107 BJ104□AHT		10	X5R	0.1 μ	±10, ±20	3.5	150	0.8±0.10	*1, *2
TMK107 BJ224□AHT			X5R	0.22 μ	±10, ±20	5	150	0.8±0.10	*1, *2
TMK107 BJ474□AHT			X5R	0.47 μ	±10, ±20	3.5	150	0.8±0.10	*1, *2
TMK107 BJ105□AHT			X5R	1 μ	±10, ±20	10	150	0.8±0.10	*1, *2
TMK107BBJ225□AHT		16	X5R	2.2 μ	±10, ±20	10	150	0.8+0.20/-0	*1, *2
EMK107 BJ104□AHT			X5R	0.1 μ	±10, ±20	3.5	150	0.8±0.10	*1, *2
EMK107 BJ224□AHT			X5R	0.22 μ	±10, ±20	5	150	0.8±0.10	*1, *2
EMK107 BJ474□AHT			X5R	0.47 μ	±10, ±20	3.5	150	0.8±0.10	*1, *2
EMK107 BJ105□AHT		10	X5R	1 μ	±10, ±20	5	150	0.8±0.10	*1, *2
EMK107ABJ225□AHT			X5R	2.2 μ	±10, ±20	10	150	0.8+0.15/-0.05	*1, *2
EMK107BBJ475□AHT			X5R	4.7 μ	±10, ±20	10	150	0.8+0.20/-0	*1, *2
EMK107 BJ474□AHT			X5R	0.47 μ	±10, ±20	3.5	150	0.8±0.10	*1, *2
LMK107 BJ105□AHT		6.3	X5R	1 μ	±10, ±20	5	150	0.8±0.10	*1, *2
LMK107 BJ225□AHT			X5R	2.2 μ	±10, ±20	10	150	0.8±0.10	*1, *2
LMK107 BJ475□AHT			X5R	4.7 μ	±10, ±20	10	150	0.8±0.10	*1, *2
LMK107BBJ106MAHT			X5R	10 μ	±20	10	150	0.8+0.20/-0	*1, *2
JMK107 BJ225□AHT		4	X5R	2.2 μ	±10, ±20	10	150	0.8±0.10	*1, *2
JMK107 BJ475□AHT			X5R	4.7 μ	±10, ±20	10	150	0.8±0.10	*1, *2
JMK107ABJ106MAHT			X5R	10 μ	±20	10	150	0.8+0.15/-0.05	*1, *2
AMK107ABJ106MAHT			X5R	10 μ	±20	10	150	0.8+0.15/-0.05	*1, *2
AMK107BBJ226MAHT		X5R	22 μ	±20	10	150	0.8+0.20/-0	*1, *2	

[Temperature Characteristic B7 : X7R, D7 : X7T] 0.8mm thickness (A)

Part number 1	Part number 2	Rated voltage [V]	Temperature characteristics	Capacitance [F]	Capacitance tolerance [%]	tan δ [%]	HALT	Thickness*3 [mm]	Note	
							Rated voltage x %			
UMK107 B7102□AHT		50	X7R	1000 p	±10, ±20	3.5	200	0.8±0.10	*1, *2	
UMK107 B7152□AHT			X7R	1500 p	±10, ±20	3.5	200	0.8±0.10	*1, *2	
UMK107 B7222□AHT			X7R	2200 p	±10, ±20	3.5	200	0.8±0.10	*1, *2	
UMK107 B7332□AHT			X7R	3300 p	±10, ±20	3.5	200	0.8±0.10	*1, *2	
UMK107 B7472□AHT			X7R	4700 p	±10, ±20	3.5	200	0.8±0.10	*1, *2	
UMK107 B7682□AHT			X7R	6800 p	±10, ±20	3.5	200	0.8±0.10	*1, *2	
UMK107 B7103□AHT			X7R	0.01 μ	±10, ±20	3.5	200	0.8±0.10	*1, *2	
UMK107 B7223□AHT			X7R	0.022 μ	±10, ±20	3.5	200	0.8±0.10	*1, *2	
UMK107 B7473□AHT			X7R	0.047 μ	±10, ±20	3.5	200	0.8±0.10	*1, *2	
UMK107 B7104□AHT			35	X7R	0.1 μ	±10, ±20	3.5	200	0.8±0.10	*1, *2
GMK107 B7473□AHT				X7R	0.047 μ	±10, ±20	3.5	200	0.8±0.10	*1, *2
GMK107 B7104□AHT				X7R	0.1 μ	±10, ±20	3.5	150	0.8±0.10	*1, *2
GMK107 B7224□AHT		X7R		0.22 μ	±10, ±20	10	150	0.8±0.10	*1, *2	
GMK107 B7474□AHT		25	X7R	0.47 μ	±10, ±20	10	150	0.8±0.10	*1, *2	
GMK107AB7105□AHT			X7R	1 μ	±10, ±20	10	150	0.8+0.15/-0.05	*1, *2	
TMK107 B7223□AHT			X7R	0.022 μ	±10, ±20	2.5	200	0.8±0.10	*1, *2	
TMK107 B7473□AHT			X7R	0.047 μ	±10, ±20	3.5	200	0.8±0.10	*1, *2	
TMK107 B7104□AHT		10	X7R	0.1 μ	±10, ±20	3.5	150	0.8±0.10	*1, *2	
TMK107 B7224□AHT			X7R	0.22 μ	±10, ±20	10	150	0.8±0.10	*1, *2	
TMK107 B7474□AHT			X7R	0.47 μ	±10, ±20	10	150	0.8±0.10	*1, *2	
TMK107AB7105□AHT			X7R	1 μ	±10, ±20	10	150	0.8+0.15/-0.05	*1, *2	
EMK107 B7473□AHT		16	X7R	0.047 μ	±10, ±20	3.5	200	0.8±0.10	*1, *2	
EMK107 B7104□AHT			X7R	0.1 μ	±10, ±20	3.5	150	0.8±0.10	*1, *2	
EMK107 B7224□AHT			X7R	0.22 μ	±10, ±20	5	150	0.8±0.10	*1, *2	
EMK107 B7474□AHT			X7R	0.47 μ	±10, ±20	10	150	0.8±0.10	*1, *2	
EMK107 B7105□AHT		10	X7R	1 μ	±10, ±20	10	150	0.8±0.10	*1, *2	
LMK107 B7224□AHT			X7R	0.22 μ	±10, ±20	5	150	0.8±0.10	*1, *2	
LMK107 B7474□AHT			X7R	0.47 μ	±10, ±20	3.5	150	0.8±0.10	*1, *2	
LMK107 B7105□AHT			X7R	1 μ	±10, ±20	10	150	0.8±0.10	*1, *2	
LMK107BD7225□AHT		6.3	X7T	2.2 μ	±10, ±20	10	150	0.8+0.2/-0	*1, *2	
JMK107 B7225□AHT			X7R	2.2 μ	±10, ±20	10	150	0.8±0.10	*1, *2	

● 212TYPE (Dimension:2.0×1.25mm JIS:2012 EIA:0805)

[Temperature Characteristic BJ : X5R] 1.25mm thickness (G)

Part number 1	Part number 2	Rated voltage [V]	Temperature characteristics	Capacitance [F]	Capacitance tolerance [%]	tan δ [%]	HALT	Thickness*3 [mm]	Note
							Rated voltage x %		
UMK212 BJ104□GHT		50	X5R	0.1 μ	±10, ±20	3.5	200	1.25±0.10	*1, *2
UMK212 BJ224□GHT			X5R	0.22 μ	±10, ±20	3.5	150	1.25±0.10	*1, *2
UMK212 BJ474□GHT			X5R	0.47 μ	±10, ±20	3.5	150	1.25±0.10	*1, *2
UMK212 BJ105□GHT			X5R	1 μ	±10, ±20	5	150	1.25±0.10	*1, *2
GMK212 BJ104□GHT		35	X5R	0.1 μ	±10, ±20	3.5	200	1.25±0.10	*1, *2
GMK212 BJ224□GHT			X5R	0.22 μ	±10, ±20	3.5	150	1.25±0.10	*1, *2
GMK212 BJ474□GHT			X5R	0.47 μ	±10, ±20	3.5	150	1.25±0.10	*1, *2
GMK212 BJ105□GHT			X5R	1 μ	±10, ±20	5	150	1.25±0.10	*1, *2
GMK212BBJ225□GHT		6.3	X5R	2.2 μ	±10, ±20	10	150	1.25+0.20/-0	*1, *2

▶ This catalog contains the typical specification only due to the limitation of space. When you consider the purchase of our products, please check our specification. For details of each product (characteristics graph, reliability information, precautions for use, and so on), see our Web site (<http://www.ty-top.com/>).

■ PART NUMBER

Part number 1	Part number 2	Rated voltage [V]	Temperature characteristics	Capacitance [F]	Capacitance tolerance [%]	tan δ [%]	HALT	Thickness*3 [mm]	Note	
							Rated voltage x %			
TMK212 BJ104[GHT]		25	X5R	0.1 μ	±10, ±20	3.5	200	1.25±0.10	*1,*2	
TMK212 BJ224[GHT]			X5R	0.22 μ	±10, ±20	3.5	150	1.25±0.10	*1,*2	
TMK212 BJ474[GHT]			X5R	0.47 μ	±10, ±20	3.5	200	1.25±0.10	*1,*2	
TMK212 BJ105[GHT]			X5R	1 μ	±10, ±20	3.5	150	1.25±0.10	*1,*2	
TMK212 BJ225[GHT]			X5R	2.2 μ	±10, ±20	5	150	1.25±0.10	*1,*2	
TMK212BBJ475[GHT]			X5R	4.7 μ	±10, ±20	10	150	1.25+0.20/-0	*1,*2	
TMK212BBJ106[GHT]		16	X5R	10 μ	±10, ±20	10	150	1.25+0.20/-0	*1,*2	
EMK212 BJ105[GHT]			X5R	1 μ	±10, ±20	3.5	150	1.25±0.10	*1,*2	
EMK212 BJ225[GHT]			X5R	2.2 μ	±10, ±20	5	200	1.25±0.10	*1,*2	
EMK212ABJ475[GHT]			X5R	4.7 μ	±10, ±20	10	150	1.25+0.15/-0.05	*1,*2	
EMK212BBJ106[GHT]			X5R	10 μ	±10, ±20	10	150	1.25+0.20/-0	*1,*2	
LМК212 BJ225[GHT]			10	X5R	2.2 μ	±10, ±20	5	200	1.25±0.10	*1,*2
LМК212ABJ475[GHT]		X5R		4.7 μ	±10, ±20	10	150	1.25+0.15/-0.05	*1,*2	
LМК212ABJ106[GHT]		X5R		10 μ	±10, ±20	10	150	1.25+0.15/-0.05	*1,*2	
JMK212ABJ475[GHT]		X5R		4.7 μ	±10, ±20	5	200	1.25+0.15/-0.05	*1,*2	
JMK212ABJ106[GHT]		6.3		X5R	10 μ	±10, ±20	10	150	1.25+0.15/-0.05	*1,*2
JMK212BBJ226MGHT				X5R	22 μ	±20	10	150	1.25+0.20/-0	*1,*2
AMK212ABJ226MGHT		4	X5R	22 μ	±20	10	150	1.25+0.15/-0.05	*1,*2	
AMK212BBJ476MGHT			X5R	47 μ	±20	10	150	1.25+0.20/-0	*1,*2	

[Temperature Characteristic BJ : X5R] 0.85mm thickness(D)

Part number 1	Part number 2	Rated voltage [V]	Temperature characteristics	Capacitance [F]	Capacitance tolerance [%]	tan δ [%]	HALT	Thickness*3 [mm]	Note
							Rated voltage x %		
EMK212 BJ105[DHT]		16	X5R	1 μ	±10, ±20	5	200	0.85±0.10	*1,*2
EMK212ABJ225[DHT]			X5R	2.2 μ	±10, ±20	5	150	0.85±0.10	*1,*2
EMK212BBJ475[DHT]			X5R	4.7 μ	±10, ±20	10	150	0.85±0.10	*1,*2

[Temperature Characteristic B7 : X7R] 1.25mm thickness(G)

Part number 1	Part number 2	Rated voltage [V]	Temperature characteristics	Capacitance [F]	Capacitance tolerance [%]	tan δ [%]	HALT	Thickness*3 [mm]	Note	
							Rated voltage x %			
UMK212 B7103[GHT]		50	X7R	0.01 μ	±10, ±20	3.5	200	1.25±0.10	*1,*2	
UMK212 B7223[GHT]			X7R	0.022 μ	±10, ±20	3.5	200	1.25±0.10	*1,*2	
UMK212 B7473[GHT]			X7R	0.047 μ	±10, ±20	3.5	200	1.25±0.10	*1,*2	
UMK212 B7104[GHT]			X7R	0.1 μ	±10, ±20	3.5	200	1.25±0.10	*1,*2	
UMK212 B7224[GHT]			X7R	0.22 μ	±10, ±20	3.5	150	1.25±0.10	*1,*2	
UMK212 B7105[GHT]			X7R	1 μ	±10, ±20	10	150	1.25±0.10	*1,*2	
GMK212 B7224[GHT]		35	X7R	0.22 μ	±10, ±20	3.5	150	1.25±0.10	*1,*2	
GMK212 B7105[GHT]			X7R	1 μ	±10, ±20	10	150	1.25±0.10	*1,*2	
TMK212 B7224[GHT]		25	X7R	0.22 μ	±10, ±20	3.5	150	1.25±0.10	*1,*2	
TMK212 B7474[GHT]			X7R	0.47 μ	±10, ±20	3.5	150	1.25±0.10	*1,*2	
TMK212 B7105[GHT]			X7R	1 μ	±10, ±20	3.5	150	1.25±0.10	*1,*2	
TMK212 B7225[GHT]		16	X7R	2.2 μ	±10, ±20	10	150	1.25±0.10	*1,*2	
EMK212 B7224[GHT]			X7R	0.22 μ	±10, ±20	3.5	150	1.25±0.10	*1,*2	
EMK212 B7474[GHT]			X7R	0.47 μ	±10, ±20	3.5	150	1.25±0.10	*1,*2	
EMK212 B7105[GHT]			X7R	1 μ	±10, ±20	3.5	150	1.25±0.10	*1,*2	
EMK212 B7225[GHT]			10	X7R	2.2 μ	±10, ±20	10	150	1.25±0.10	*1,*2
EMK212ABJ475[GHT]				X7R	4.7 μ	±10, ±20	10	150	1.25+0.15/-0.05	*1,*2
LМК212 B7105[GHT]		6.3	X7R	1 μ	±10, ±20	3.5	150	1.25±0.10	*1,*2	
LМК212 B7225[GHT]			X7R	2.2 μ	±10, ±20	10	150	1.25±0.10	*1,*2	
LМК212 B7475[GHT]			X7R	4.7 μ	±10, ±20	10	150	1.25±0.10	*1,*2	
JMK212ABJ106[GHT]			X7R	10 μ	±10, ±20	10	150	1.25+0.15/-0.05	*1,*2	

● 316TYPE (Dimension:3.2×1.6mm JIS:3216 EIA:1206)

[Temperature Characteristic BJ : X5R] 1.6mm thickness(L)

Part number 1	Part number 2	Rated voltage [V]	Temperature characteristics	Capacitance [F]	Capacitance tolerance [%]	tan δ [%]	HALT	Thickness*3 [mm]	Note	
							Rated voltage x %			
UMK316 BJ474[LHT]		50	X5R	0.47 μ	±10, ±20	3.5	200	1.6±0.20	*1,*2	
UMK316 BJ105[LHT]			X5R	1 μ	±10, ±20	3.5	200	1.6±0.20	*1,*2	
UMK316 BJ225[LHT]			X5R	2.2 μ	±10, ±20	10	150	1.6±0.20	*1,*2	
UMK316ABJ475[LHT]			X5R	4.7 μ	±10, ±20	10	150	1.6±0.20	*1,*2	
GMK316 BJ105[LHT]			35	X5R	1 μ	±10, ±20	3.5	200	1.6±0.20	*1,*2
GMK316 BJ225[LHT]				X5R	2.2 μ	±10, ±20	10	150	1.6±0.20	*1,*2
GMK316 BJ475[LHT]		25	X5R	4.7 μ	±10, ±20	10	150	1.6±0.20	*1,*2	
GMK316BBJ106MLHT			X5R	10 μ	±20	10	150	1.6±0.30	*1,*2	
TMK316 BJ225[LHT]			X5R	2.2 μ	±10, ±20	3.5	200	1.6±0.20	*1,*2	
TMK316 BJ475[LHT]			X5R	4.7 μ	±10, ±20	5	150	1.6±0.20	*1,*2	
TMK316 BJ106[LHT]			16	X5R	10 μ	±10, ±20	5	150	1.6±0.20	*1,*2
EMK316 BJ225[LHT]				X5R	2.2 μ	±10, ±20	3.5	200	1.6±0.20	*1,*2
EMK316 BJ475[LHT]		10	X5R	4.7 μ	±10, ±20	5	150	1.6±0.20	*1,*2	
EMK316 BJ106[LHT]			X5R	10 μ	±10, ±20	5	150	1.6±0.20	*1,*2	
EMK316BBJ226MLHT			X5R	22 μ	±20	10	150	1.6±0.30	*1,*2	
LМК316 BJ475[LHT]			6.3	X5R	4.7 μ	±10, ±20	5	150	1.6±0.20	*1,*2
LМК316 BJ106[LHT]				X5R	10 μ	±10, ±20	5	150	1.6±0.20	*1,*2
LМК316ABJ226[LHT]				X5R	22 μ	±10, ±20	10	150	1.6±0.20	*1,*2
JMK316 BJ106[LHT]		4	X5R	10 μ	±10, ±20	5	200	1.6±0.20	*1,*2	
JMK316ABJ226[LHT]			X5R	22 μ	±10, ±20	10	150	1.6±0.20	*1,*2	
JMK316ABJ476MLHT			X5R	47 μ	±20	10	150	1.6±0.20	*1,*2	
JMK316BBJ107MLHT			X5R	100 μ	±20	10	150	1.6±0.30	*2	
AMK316ABJ107MLHT			X5R	100 μ	±20	10	150	1.6±0.20	*2	

▶ This catalog contains the typical specification only due to the limitation of space. When you consider the purchase of our products, please check our specification. For details of each product (characteristics graph, reliability information, precautions for use, and so on), see our Web site (<http://www.ty-top.com/>).

■ PART NUMBER

[Temperature Characteristic B7 : X7R , C7 : X7S] 1.6mm thickness(L)

Part number 1	Part number 2	Rated voltage [V]	Temperature characteristics	Capacitance [F]	Capacitance tolerance [%]	tan δ [%]	HALT	Thickness*3 [mm]	Note
							Rated voltage x %		
UMK316 B7473□LHT		50	X7R	0.047 μ	±10, ±20	3.5	200	1.6±0.20	*1 *2
UMK316 B7104□LHT			X7R	0.1 μ	±10, ±20	3.5	200	1.6±0.20	*1 *2
UMK316 B7224□LHT			X7R	0.22 μ	±10, ±20	3.5	200	1.6±0.20	*1 *2
UMK316 B7474□LHT			X7R	0.47 μ	±10, ±20	3.5	200	1.6±0.20	*1 *2
UMK316 B7105□LHT			X7R	1 μ	±10, ±20	3.5	200	1.6±0.20	*1 *2
UMK316 B7225□LHT			X7R	2.2 μ	±10, ±20	10	150	1.6±0.20	*1 *2
GMK316 B7105□LHT		35	X7R	1 μ	±10, ±20	3.5	200	1.6±0.20	*1 *2
GMK316 B7225□LHT			X7R	2.2 μ	±10, ±20	10	150	1.6±0.20	*1 *2
GMK316AB7475□LHT			X7R	4.7 μ	±10, ±20	10	150	1.6±0.20	*1 *2
TMK316 B7225□LHT		25	X7R	2.2 μ	±10, ±20	3.5	200	1.6±0.20	*1 *2
TMK316AB7475□LHT			X7R	4.7 μ	±10, ±20	10	150	1.6±0.20	*1 *2
TMK316AB7106□LHT			X7R	10 μ	±10, ±20	10	150	1.6±0.20	*1 *2
EMK316 B7225□LHT		16	X7R	2.2 μ	±10, ±20	3.5	200	1.6±0.20	*1 *2
EMK316AB7475□LHT			X7R	4.7 μ	±10, ±20	10	150	1.6±0.20	*1 *2
EMK316AB7106□LHT			X7R	10 μ	±10, ±20	10	150	1.6±0.20	*1 *2
LMK316 B7475□LHT		10	X7R	4.7 μ	±10, ±20	5	150	1.6±0.20	*1 *2
LMK316AB7106□LHT			X7R	10 μ	±10, ±20	10	150	1.6±0.20	*1 *2
JMK316AB7106□LHT			X7R	10 μ	±10, ±20	10	150	1.6±0.20	*1 *2
JMK316AB7226□LHT		6.3	X7R	22 μ	±10, ±20	10	150	1.6±0.20	*1 *2
AMK316AB7226□LHT			X7R	22 μ	±10, ±20	10	150	1.6±0.20	*1 *2
AMK316AC7476MLHT		4	X7R	22 μ	±10, ±20	10	150	1.6±0.20	*1 *2
			X7S	47 μ	±20	10	150	1.6±0.20	*1 *2

● 325TYPE (Dimension:3.2 × 2.5mm JIS:3225 EIA:1210)

[Temperature Characteristic BJ : X5R] 2.5mm thickness(M)

Part number 1	Part number 2	Rated voltage [V]	Temperature characteristics	Capacitance [F]	Capacitance tolerance [%]	tan δ [%]	HALT	Thickness*3 [mm]	Note
							Rated voltage x %		
UMK325 BJ106□MHP	UMK325 BJ106□MHT	50	X5R	10 μ	±10, ±20	5	150	2.5±0.20	*1 *2
GMK325 BJ106□MHP	GMK325 BJ106□MHT	35	X5R	10 μ	±10, ±20	5	150	2.5±0.20	*1 *2
TMK325 BJ106□MHP	TMK325 BJ106□MHT	25	X5R	10 μ	±10, ±20	5	150	2.5±0.20	*1 *2
EMK325 BJ226□MHP	EMK325 BJ226□MHT	16	X5R	22 μ	±10, ±20	5	150	2.5±0.20	*1 *2
LMK325 BJ226□MHP	LMK325 BJ226□MHT	10	X5R	22 μ	±10, ±20	5	150	2.5±0.20	*1 *2
LMK325 BJ476MMHP	LMK325 BJ476MMHT		X5R	47 μ	±20	10	150	2.5±0.20	*1 *2
LMK325ABJ107MMHP	LMK325ABJ107MMHT		X5R	100 μ	±20	10	150	2.5±0.30	*2
JMK325 BJ476MMHP	JMK325 BJ476MMHT	6.3	X5R	47 μ	±20	10	150	2.5±0.20	*1 *2
JMK325ABJ107MMHP	JMK325ABJ107MMHT		X5R	100 μ	±20	10	150	2.5±0.30	*2
AMK325ABJ107MMHP	AMK325ABJ107MMHT		X5R	100 μ	±20	10	150	2.5±0.30	*2
AMK325ABJ227MMHP	AMK325ABJ227MMHT	4	X5R	220 μ	±20	10	150	2.5±0.30	*2

[Temperature Characteristic BJ : X5R] 1.9mm thickness(N)

Part number 1	Part number 2	Rated voltage [V]	Temperature characteristics	Capacitance [F]	Capacitance tolerance [%]	tan δ [%]	HALT	Thickness*3 [mm]	Note
							Rated voltage x %		
UMK325 BJ475□NHT		50	X5R	4.7 μ	±10, ±20	10	150	1.9±0.20	*1 *2
GMK325 BJ225MNHT		35	X5R	2.2 μ	±20	3.5	200	1.9±0.20	*1 *2
GMK325 BJ475□NHT			X5R	4.7 μ	±10, ±20	10	150	1.9±0.20	*1 *2
TMK325 BJ475□NHT		25	X5R	4.7 μ	±10, ±20	10	150	1.9±0.20	*1 *2
EMK325 BJ475MNHT		16	X5R	4.7 μ	±20	3.5	200	1.9±0.20	*1 *2
EMK325 BJ106□NHT			X5R	10 μ	±10, ±20	5	150	1.9±0.20	*1 *2

[Temperature Characteristic BJ : X5R] 1.5mm thickness(H)

Part number 1	Part number 2	Rated voltage [V]	Temperature characteristics	Capacitance [F]	Capacitance tolerance [%]	tan δ [%]	HALT	Thickness*3 [mm]	Note
							Rated voltage x %		
UMK325 BJ105MHHT		50	X5R	1 μ	±20	3.5	200	1.5±0.10	*1 *2
TMK325 BJ225MHHT		25	X5R	2.2 μ	±20	3.5	200	1.5±0.10	*1 *2

[Temperature Characteristic C6 : X6S] 2.5mm thickness(M)

Part number 1	Part number 2	Rated voltage [V]	Temperature characteristics	Capacitance [F]	Capacitance tolerance [%]	tan δ [%]	HALT	Thickness*3 [mm]	Note
							Rated voltage x %		
JMK325AC6107MMHP	JMK325AC6107MMHT	6.3	X6S	100 μ	±20	10	150	2.5±0.30	*2

[Temperature Characteristic B7 : X7R , C7 : X7S] 2.5mm thickness(M)

Part number 1	Part number 2	Rated voltage [V]	Temperature characteristics	Capacitance [F]	Capacitance tolerance [%]	tan δ [%]	HALT	Thickness*3 [mm]	Note
							Rated voltage x %		
UMK325 B7475□MHP	UMK325 B7475□MHT	50	X7R	4.7 μ	±10, ±20	5	150	2.5±0.20	*1 *2
UMK325AB7106□MHP	UMK325AB7106□MHT		X7R	10 μ	±10, ±20	10	150	2.5±0.30	*1 *2
UMK325AC7106MMHP	UMK325AC7106MMHT		X7S	10 μ	±20	10	150	2.5±0.30	*1 *2
GMK325AB7106□MHP		35	X7R	10 μ	±10, ±20	10	150	2.5±0.30	*1 *2
GMK325 C7106□MHP	GMK325 C7106□MHT		X7S	10 μ	±10, ±20	5	150	2.5±0.20	*1 *2
TMK325AB7106□MHP	TMK325AB7106□MHT	25	X7R	10 μ	±10, ±20	10	150	2.5±0.30	*1 *2
TMK325 B7226□MHP	TMK325 B7226□MHT		X7R	22 μ	±10, ±20	10	150	2.5±0.20	*1 *2
EMK325 B7226□MHP	EMK325 B7226□MHT	16	X7R	22 μ	±10, ±20	10	150	2.5±0.20	*1 *2
LMK325 B7226□MHP			X7R	22 μ	±10, ±20	10	150	2.5±0.20	*1 *2
LMK325 C7226MMHP	LMK325 C7226MMHT	10	X7S	22 μ	±20	5	150	2.5±0.20	*1 *2
JMK325 B7226□MHP	JMK325 B7226□MHT		X7R	22 μ	±10, ±20	10	150	2.5±0.20	*1 *2
JMK325 B7476□MHP	JMK325 B7476□MHT	6.3	X7R	47 μ	±10, ±20	10	150	2.5±0.20	*1 *2

[Temperature Characteristic B7 : X7R] 1.9mm thickness(N)

Part number 1	Part number 2	Rated voltage [V]	Temperature characteristics	Capacitance [F]	Capacitance tolerance [%]	tan δ [%]	HALT	Thickness*3 [mm]	Note
							Rated voltage x %		
GMK325 B7225□NHT		35	X7R	2.2 μ	±10, ±20	3.5	200	1.9±0.20	*1 *2
GMK325 B7475MNHT			X7R	4.7 μ	±20	10	150	1.9±0.20	*1 *2
TMK325 B7475□NHT		25	X7R	4.7 μ	±10, ±20	10	150	1.9±0.20	*1 *2
EMK325 B7106□NHT		16	X7R	10 μ	±10, ±20	5	150	1.9±0.20	*1 *2

▶ This catalog contains the typical specification only due to the limitation of space. When you consider the purchase of our products, please check our specification. For details of each product (characteristics graph, reliability information, precautions for use, and so on), see our Web site (<http://www.ty-top.com/>).

■ PART NUMBER

[Temperature Characteristic B7 : X7R] 1.5mm thickness(H)

Part number 1	Part number 2	Rated voltage [V]	Temperature characteristics	Capacitance [F]	Capacitance tolerance [%]	tan δ [%]	HALT		Thickness*3 [mm]	Note
							Rated voltage x %			
UMK325 B7105□HHT		50	X7R	1 μ	±10, ±20	3.5	200		1.5±0.10	*1,*2

Multilayer Ceramic Capacitors (Temperature compensating type)

● 063TYPE (Dimension:0.6×0.3mm JIS:0603 EIA:0201)

[Temperature Characteristic CG : CG/COG] 0.3mm thickness(T)

Part number 1	Part number 2	Rated voltage [V]	Temperature characteristics	Capacitance [F]	Capacitance tolerance [%]	Q [at 1MHz] (Min)	HALT		Thickness*3 [mm]	Note
							Rated voltage x %			
UMK063 CG0R5CTHF		50	CG	C0G	0.5 p	± 0.25pF	410	200	0.3±0.03	*1,*2
UMK063 CG010CTHF			CG	C0G	1 p	± 0.25pF	420	200	0.3±0.03	*1,*2
UMK063 CG1R5CTHF			CG	C0G	1.5 p	± 0.25pF	430	200	0.3±0.03	*1,*2
UMK063 CG020CTHF			CG	C0G	2 p	± 0.25pF	440	200	0.3±0.03	*1,*2
UMK063 CG030CTHF			CG	C0G	3 p	± 0.25pF	460	200	0.3±0.03	*1,*2
UMK063 CG040CTHF			CG	C0G	4 p	± 0.25pF	480	200	0.3±0.03	*1,*2
UMK063 CG050CTHF			CG	C0G	5 p	± 0.25pF	500	200	0.3±0.03	*1,*2
UMK063 CG060DTHF			CG	C0G	6 p	± 0.5pF	520	200	0.3±0.03	*1,*2
UMK063 CG070DTHF			CG	C0G	7 p	± 0.5pF	540	200	0.3±0.03	*1,*2
UMK063 CG080DTHF			CG	C0G	8 p	± 0.5pF	560	200	0.3±0.03	*1,*2
UMK063 CG090DTHF			CG	C0G	9 p	± 0.5pF	580	200	0.3±0.03	*1,*2
UMK063 CG100DTHF			CG	C0G	10 p	± 0.5pF	600	200	0.3±0.03	*1,*2
UMK063 CG120JTHF			CG	C0G	12 p	± 5 %	640	200	0.3±0.03	*1,*2
UMK063 CG150JTHF			CG	C0G	15 p	± 5 %	700	200	0.3±0.03	*1,*2
UMK063 CG180JTHF			CG	C0G	18 p	± 5 %	760	200	0.3±0.03	*1,*2
UMK063 CG220JTHF			CG	C0G	22 p	± 5 %	840	200	0.3±0.03	*1,*2
UMK063 CG270JTHF			CG	C0G	27 p	± 5 %	940	200	0.3±0.03	*1,*2
UMK063 CG330JTHF			CG	C0G	33 p	± 5 %	1000	200	0.3±0.03	*1,*2
UMK063 CG390JTHF			CG	C0G	39 p	± 5 %	1000	200	0.3±0.03	*1,*2
UMK063 CG470JTHF			CG	C0G	47 p	± 5 %	1000	200	0.3±0.03	*1,*2
UMK063 CG560JTHF			CG	C0G	56 p	± 5 %	1000	200	0.3±0.03	*1,*2
UMK063 CG680JTHF			CG	C0G	68 p	± 5 %	1000	200	0.3±0.03	*1,*2
UMK063 CG820JTHF			CG	C0G	82 p	± 5 %	1000	200	0.3±0.03	*1,*2
UMK063 CG101JTHF			CG	C0G	100 p	± 5 %	1000	200	0.3±0.03	*1,*2
UMK063 CG121JTHF			CG	C0G	120 p	± 5 %	1000	200	0.3±0.03	*1,*2
UMK063 CG151JTHF		CG	C0G	150 p	± 5 %	1000	200	0.3±0.03	*1,*2	
UMK063 CG181JTHF		CG	C0G	180 p	± 5 %	1000	200	0.3±0.03	*1,*2	
UMK063 CG221JTHF		CG	C0G	220 p	± 5 %	1000	200	0.3±0.03	*1,*2	

● 105TYPE (Dimension:1.0×0.5mm JIS:1005 EIA:0402)

[Temperature Characteristic CG : CG/COG] 0.5mm thickness(V)

Part number 1	Part number 2	Rated voltage [V]	Temperature characteristics	Capacitance [F]	Capacitance tolerance [%]	Q [at 1MHz] (Min)	HALT		Thickness*3 [mm]	Note
							Rated voltage x %			
UMK105 CG0R5CVHF		50	CG	C0G	0.5 p	± 0.25pF	410	200	0.5±0.05	*1,*2
UMK105 CG010CVHF			CG	C0G	1 p	± 0.25pF	420	200	0.5±0.05	*1,*2
UMK105 CG1R5CVHF			CG	C0G	1.5 p	± 0.25pF	430	200	0.5±0.05	*1,*2
UMK105 CG020CVHF			CG	C0G	2 p	± 0.25pF	440	200	0.5±0.05	*1,*2
UMK105 CG030CVHF			CG	C0G	3 p	± 0.25pF	460	200	0.5±0.05	*1,*2
UMK105 CG040CVHF			CG	C0G	4 p	± 0.25pF	480	200	0.5±0.05	*1,*2
UMK105 CG050CVHF			CG	C0G	5 p	± 0.25pF	500	200	0.5±0.05	*1,*2
UMK105 CG060DVHF			CG	C0G	6 p	± 0.5pF	520	200	0.5±0.05	*1,*2
UMK105 CG070DVHF			CG	C0G	7 p	± 0.5pF	540	200	0.5±0.05	*1,*2
UMK105 CG080DVHF			CG	C0G	8 p	± 0.5pF	560	200	0.5±0.05	*1,*2
UMK105 CG090DVHF			CG	C0G	9 p	± 0.5pF	580	200	0.5±0.05	*1,*2
UMK105 CG100DVHF			CG	C0G	10 p	± 0.5pF	600	200	0.5±0.05	*1,*2
UMK105 CG120JVHF			CG	C0G	12 p	± 5%	640	200	0.5±0.05	*1,*2
UMK105 CG150JVHF			CG	C0G	15 p	± 5%	700	200	0.5±0.05	*1,*2
UMK105 CG180JVHF			CG	C0G	18 p	± 5%	760	200	0.5±0.05	*1,*2
UMK105 CG220JVHF			CG	C0G	22 p	± 5%	840	200	0.5±0.05	*1,*2
UMK105 CG270JVHF			CG	C0G	27 p	± 5%	940	200	0.5±0.05	*1,*2
UMK105 CG330JVHF			CG	C0G	33 p	± 5%	1000	200	0.5±0.05	*1,*2
UMK105 CG390JVHF			CG	C0G	39 p	± 5%	1000	200	0.5±0.05	*1,*2
UMK105 CG470JVHF			CG	C0G	47 p	± 5%	1000	200	0.5±0.05	*1,*2
UMK105 CG560JVHF			CG	C0G	56 p	± 5%	1000	200	0.5±0.05	*1,*2
UMK105 CG680JVHF			CG	C0G	68 p	± 5%	1000	200	0.5±0.05	*1,*2
UMK105 CG820JVHF			CG	C0G	82 p	± 5%	1000	200	0.5±0.05	*1,*2
UMK105 CG101JVHF			CG	C0G	100 p	± 5%	1000	200	0.5±0.05	*1,*2
UMK105 CG121JVHF			CG	C0G	120 p	± 5%	1000	200	0.5±0.05	*1,*2
UMK105 CG151JVHF			CG	C0G	150 p	± 5%	1000	200	0.5±0.05	*1,*2
UMK105 CG181JVHF			CG	C0G	180 p	± 5%	1000	200	0.5±0.05	*1,*2
UMK105 CG221JVHF			CG	C0G	220 p	± 5%	1000	200	0.5±0.05	*1,*2
UMK105 CG271JVHF			CG	C0G	270 p	± 5%	1000	200	0.5±0.05	*1,*2
UMK105 CG331JVHF			CG	C0G	330 p	± 5%	1000	200	0.5±0.05	*1,*2
UMK105 CG361JVHF			CG	C0G	360 p	± 5%	1000	200	0.5±0.05	*1,*2
UMK105 CG391JVHF			CG	C0G	390 p	± 5%	1000	200	0.5±0.05	*1,*2
UMK105 CG431JVHF			CG	C0G	430 p	± 5%	1000	200	0.5±0.05	*1,*2
UMK105 CG471JVHF			CG	C0G	470 p	± 5%	1000	200	0.5±0.05	*1,*2
UMK105 CG511JVHF			CG	C0G	510 p	± 5%	1000	200	0.5±0.05	*1,*2
UMK105 CG561JVHF			CG	C0G	560 p	± 5%	1000	200	0.5±0.05	*1,*2
UMK105 CG621JVHF			CG	C0G	620 p	± 5%	1000	200	0.5±0.05	*1,*2
UMK105 CG681JVHF			CG	C0G	680 p	± 5%	1000	200	0.5±0.05	*1,*2
UMK105 CG751JVHF			CG	C0G	750 p	± 5%	1000	200	0.5±0.05	*1,*2
UMK105 CG821JVHF			CG	C0G	820 p	± 5%	1000	200	0.5±0.05	*1,*2
UMK105 CG102JVHF		CG	C0G	1000 p	± 5%	1000	200	0.5±0.05	*1,*2	

▶ This catalog contains the typical specification only due to the limitation of space. When you consider the purchase of our products, please check our specification. For details of each product (characteristics graph, reliability information, precautions for use, and so on), see our Web site (<http://www.ty-top.com/>).

Multilayer Ceramic Capacitors

PACKAGING

① Minimum Quantity

● Taped package

Type(EIA)	Thickness		Standard quantity [pcs]	
	mm	code	Paper tape	Embossed tape
□MK021(008004)	0.125	K	—	50000
□MK042(01005)	0.2	C, D	—	40000
□VS042(01005)	0.2	C		
□MK063(0201)	0.3	P, T	15000	—
□WK105(0204) ※	0.3	P	10000	
□MK105(0402)	0.13	H	—	20000
	0.18	E	—	15000
	0.2	C	20000	—
	0.3	P	15000	
	0.5	V	10000	
□VK105(0402) ※	0.5	W	—	4000
□MK107(0603)	0.45	K	—	4000
□WK107(0306) ※	0.5	V	—	
□MR107(0603)	0.8	A	4000	—
□MK212(0805)	0.45	K		
□WK212(0508) ※	0.85	D		
□MR212(0805)	125	G	—	3000
□MK316(1206)	0.85	D	4000	—
	1.15	F	—	3000
	125	G	—	2000
□MK325(1210)	1.6	L	—	2000
	0.85	D	—	
	1.15	F		
	1.9	N		
	2.0max.	Y	2000	
□MR325(1210)	2.5	M	—	1000
□MK432(1812)	2.5	M	—	500

Note : ※ LW Reverse type.

② Taping material

※No bottom tape for pressed carrier tape

● Card board carrier tape

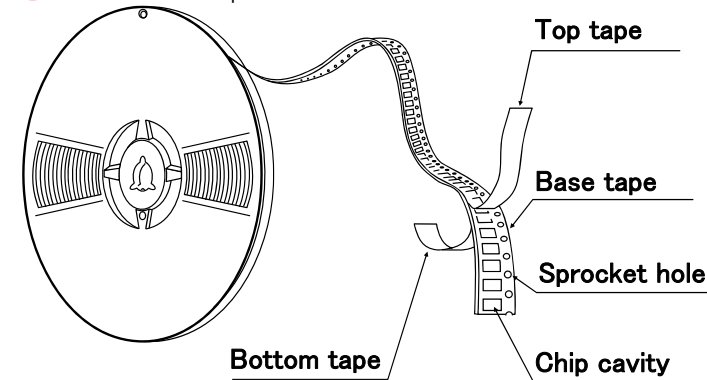

● Embossed tape

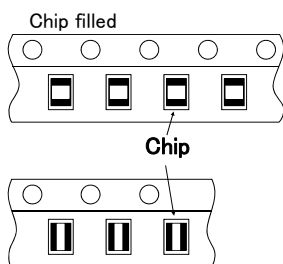
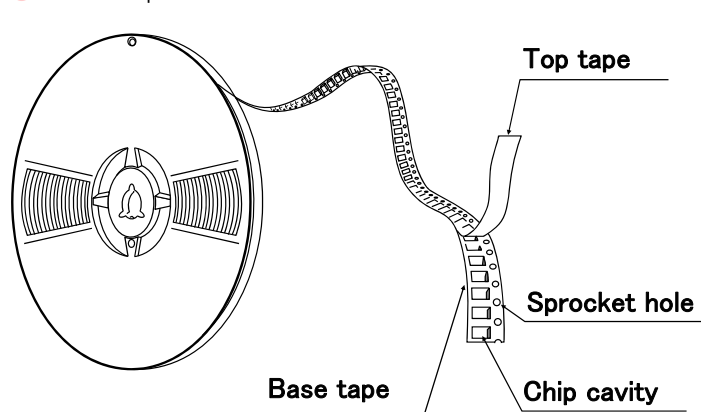

▶ This catalog contains the typical specification only due to the limitation of space. When you consider the purchase of our products, please check our specification. For details of each product (characteristics graph, reliability information, precautions for use, and so on), see our Web site (<http://www.ty-top.com/>).

③ Representative taping dimensions

- Paper Tape (8mm wide)
- Pressed carrier tape (2mm pitch)

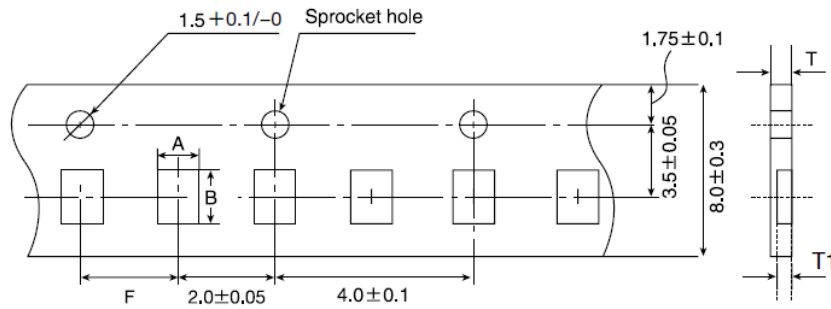

Unit : mm

Type(EIA)	Chip Cavity		Insertion Pitch F	Tape Thickness	
	A	B		T	T1
□MK063(0201)	0.37	0.67	2.0±0.05	0.45max.	0.42max.
□WK105(0204) ※	0.65	1.15		0.4max.	0.3max.
□MK105(0402) (*1 C)				0.45max.	0.42max.
□MK105(0402) (*1 P)					

Note *1 Thickness, C:0.2mm ,P:0.3mm. ※ LW Reverse type.

Unit : mm

- Punched carrier tape (2mm pitch)

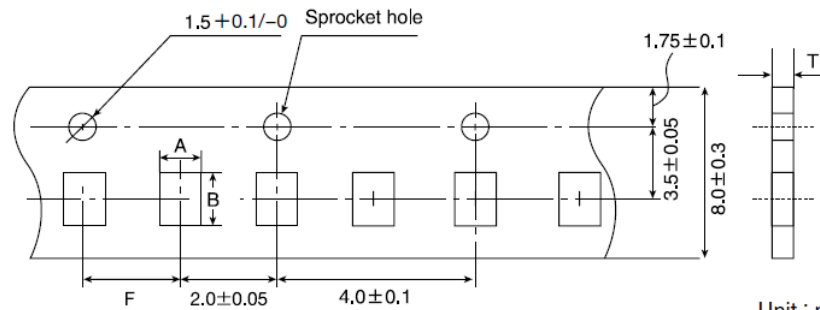

Unit : mm

Type(EIA)	Chip Cavity		Insertion Pitch F	Tape Thickness
	A	B		T
□MK105 (0402)	0.65	1.15	2.0±0.05	0.8max.
□VK105 (0402)				

Unit : mm

- Punched carrier tape (4mm pitch)

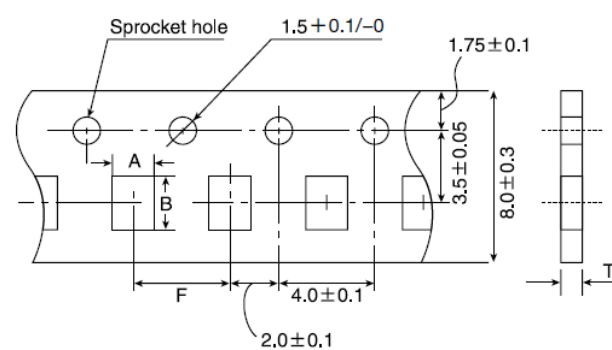

Unit : mm

Type(EIA)	Chip Cavity		Insertion Pitch F	Tape Thickness
	A	B		T
□MK107(0603)	1.0	1.8	4.0±0.1	1.1max.
□WK107(0306) ※				
□MR107(0603)				
□MK212(0805)	1.65	2.4		1.1max.
□WK212(0508) ※				
□MK316(1206)	2.0	3.6		

Note: Taping size might be different depending on the size of the product. ※ LW Reverse type.

Unit : mm

● Embossed tape (4mm wide)

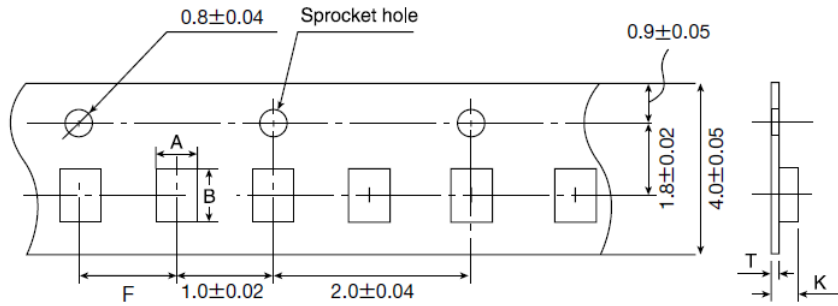

Unit : mm

Type(EIA)	Chip Cavity		Insertion Pitch F	Tape Thickness	
	A	B		K	T
□MK021(008004)	0.135	0.27	1.0±0.02	0.5max.	0.25max.
□MK042(01005)	0.23	0.43			
□VS042(01005)					

Unit : mm

● Embossed tape (8mm wide)

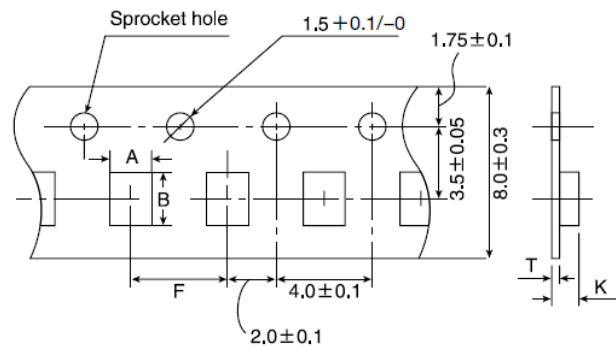

Unit : mm

Type(EIA)	Chip Cavity		Insertion Pitch F	Tape Thickness	
	A	B		K	T
□MK105(0402)	0.6	1.1	2.0±0.1	0.6max.	0.2±0.1
□WK107(0306) ※	1.0	1.8		1.3max.	0.25±0.1
□MK212(0805)	1.65	2.4	4.0±0.1	3.4max.	0.6max.
□MR212(0805)					
□MK316(1206)	2.0	3.6			
□MR316(1206)	2.8	3.6			
□MK325(1210)					
□MR325(1210)					

Note: ※ LW Reverse type.

Unit : mm

● Embossed tape (12mm wide)

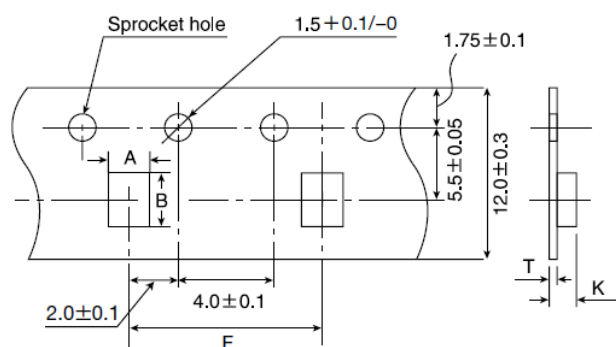

Unit : mm

Type(EIA)	Chip Cavity		Insertion Pitch F	Tape Thickness	
	A	B		K	T
□MK432(1812)	3.7	4.9	8.0±0.1	4.0max.	0.6max.

Unit : mm

④Trailer and Leader

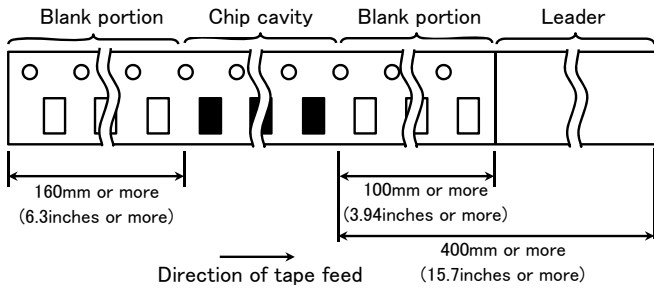

⑤Reel size

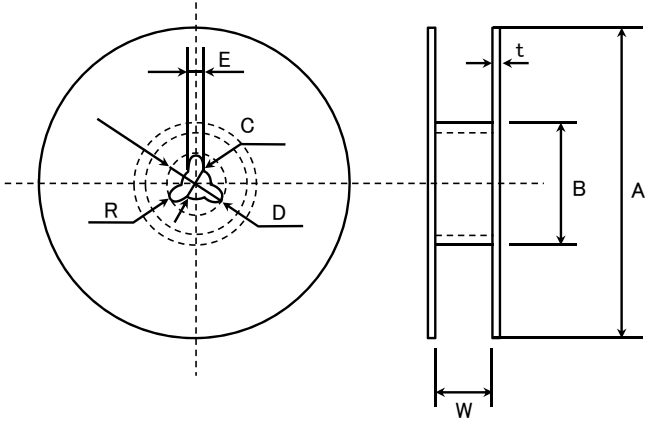

A	B	C	D	E	R
$\phi 178 \pm 2.0$	$\phi 50 \text{min.}$	$\phi 13.0 \pm 0.2$	$\phi 21.0 \pm 0.8$	2.0 ± 0.5	1.0
	T	W			
4mm wide tape	1.5max.	5 ± 1.0			
8mm wide tape	2.5max.	10 ± 1.5			
12mm wide tape	2.5max.	14 ± 1.5			

Unit: mm

⑥Top Tape Strength

The top tape requires a peel-off force of 0.1 to 0.7N in the direction of the arrow as illustrated below.

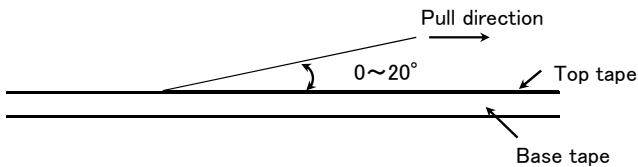

⑦Bulk Cassette

The exchange of individual specification is necessary.
Please contact Taiyo Yuden sales channels.

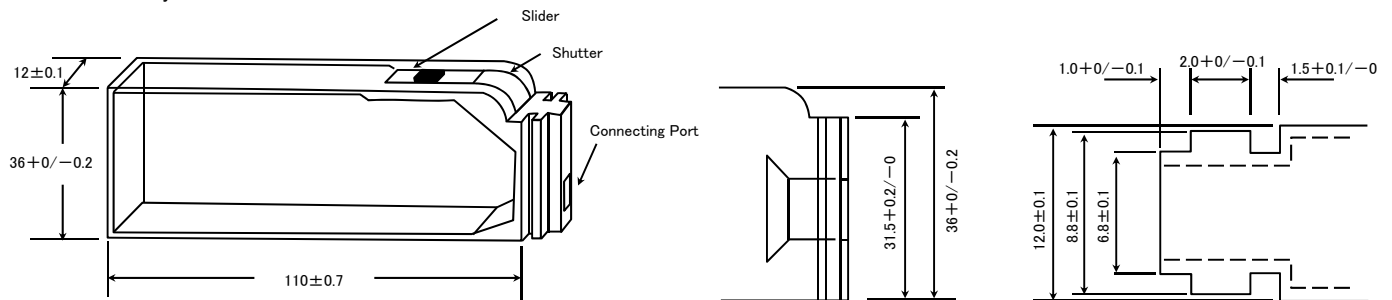

Unit: mm

Multilayer Ceramic Capacitors

RELIABILITY DATA

1. Operating Temperature Range

Specified Value	Temperature Compensating (Class1)	Standard	-55 to +125°C	
		High Frequency Type		
Specified Value	High Permittivity (Class2)			
			Specification	Temperature Range
		BJ	B	-25 to +85°C
			X5R	-55 to +85°C
		B7	X7R	-55 to +125°C
		C6	X6S	-55 to +105°C
		C7	X7S	-55 to +125°C
		D7	X7T	-55 to +125°C
LD(※)	X5R	-55 to +85°C		

Note: ※LD Low distortion high value multilayer ceramic capacitor

2. Storage Conditions

Specified Value	Temperature Compensating (Class1)	Standard	-55 to +125°C	
		High Frequency Type		
Specified Value	High Permittivity (Class2)			
			Specification	Temperature Range
		BJ	B	-25 to +85°C
			X5R	-55 to +85°C
		B7	X7R	-55 to +125°C
		C6	X6S	-55 to +105°C
		C7	X7S	-55 to +125°C
		D7	X7T	-55 to +125°C
LD(※)	X5R	-55 to +85°C		

Note: ※LD Low distortion high value multilayer ceramic capacitor

3. Rated Voltage

Specified Value	Temperature Compensating (Class1)	Standard	50VDC, 25VDC
		High Frequency Type	50VDC, 25VDC
	High Permittivity (Class2)		50VDC, 35VDC, 25VDC, 16VDC, 10VDC, 6.3VDC, 4VDC, 2.5VDC

4. Withstanding Voltage (Between terminals)

Specified Value	Temperature Compensating (Class1)	Standard	No breakdown or damage
		High Frequency Type	
Test Methods and Remarks	High Permittivity (Class2)		
		Class 1	Class 2
	Applied voltage	Rated volta × 3	Rated voltage × 2.5
	Duration	1 to 5 sec.	
	Charge/discharge current	50mA max.	

5. Insulation Resistance

Specified Value	Temperature Compensating (Class1)	Standard	10000 MΩ min.
		High Frequency Type	
Specified Value	High Permittivity (Class2) Note 1		C ≤ 0.047 μF : 10000 MΩ min. C > 0.047 μF : 500MΩ · μF
	Test Methods and Remarks	Applied voltage	: Rated voltage
	Duration	: 60 ± 5 sec.	
	Charge/discharge current	: 50mA max.	

▶ This catalog contains the typical specification only due to the limitation of space. When you consider the purchase of our products, please check our specification. For details of each product (characteristics graph, reliability information, precautions for use, and so on), see our Web site (<http://www.ty-top.com/>).

6. Capacitance (Tolerance)

Specified Value	Temperature Compensating(Class1)	Standard	C□	0.2pF ≤ C ≤ 5pF	: ±0.25pF
			U□	0.2pF ≤ C ≤ 10pF	: ±0.5pF
			SL	C > 10pF	: ±5% or ±10%
Specified Value	High Permittivity (Class2)	High Frequency Type	CH	0.3pF ≤ C ≤ 2pF	: ±0.1pF
				C > 2pF	: ±5%
			BJ, B7, C6, C7, D7, LD(※): ±10% or ±20%		
			Note: ※LD Low distortion high value multilayer ceramic capacitor		

7. Q or Dissipation Factor

Specified Value	Temperature Compensating(Class1)	Standard	C < 30pF : Q ≥ 400 + 20C		
			C ≥ 30pF : Q ≥ 1000 (C: Nominal capacitance)		
		High Frequency Type	Refer to detailed specification		
High Permittivity (Class2)		Note 1	BJ, B7, C6, C7, D7: 2.5% max.		

Test Methods and Remarks		Class 1		Class 2	
		Standard	High Frequency Type	C ≤ 10 μF	C > 10 μF
	Preconditioning	None		Thermal treatment (at 150°C for 1hr) Note 2	
	Measuring frequency	1MHz ± 10%	1GHz	1kHz ± 10%	120 ± 10Hz
	Measuring voltage Note 1	0.5 to 5Vrms		1 ± 0.2Vrms	0.5 ± 0.1rms
Bias application	one				

Test Methods and Remarks		Class 1		Class 2	
		Standard	High Frequency Type	C ≤ 10 μF	C > 10 μF
	Preconditioning	None		Thermal treatment (at 150°C for 1hr) Note 2	
	Measuring frequency	1MHz ± 10%	1GHz	1kHz ± 10%	120 ± 10Hz
	Measuring voltage Note 1	0.5 to 5Vrms		1 ± 0.2Vrms	0.5 ± 0.1Vrms
Bias application	None				
High Frequency Type					
Measuring equipment : HP4291A					
Measuring jig : HP16192A					

8. Temperature Characteristic (Without voltage application)

Specified Value	Temperature Compensating(Class1)	Standard	Temperature Characteristic [ppm/°C]		Tolerance [ppm/°C]	
			C□ : 0	CG, CH, CJ, CK	G : ±30	H : ±60
			U□ : -750	UJ, UK	J : ±120	K : ±250
			SL : +350 to -1000			
Specified Value	High Permittivity (Class2)	High Frequency Type	Temperature Characteristic [ppm/°C]		Tolerance [ppm/°C]	
			C□ : 0	CH	H : ±60	
			Specification	Capacitance change	Reference temperature	Temperature Range
			B	±10%	20°C	-25 to +85°C
			X5R	±15%	25°C	-55 to +85°C
			X7R	±15%	25°C	-55 to +125°C
			X6S	±22%	25°C	-55 to +105°C
			X7S	±22%	25°C	-55 to +125°C
			X7S	+22/-33%	25°C	-55 to +125°C
			X5R	±15%	25°C	-55 to +85°C
Note : ※LD Low distortion high value multilayer ceramic capacitor						

Test Methods and Remarks	Class 1					
	Capacitance at 20°C and 85°C shall be measured in thermal equilibrium, and the temperature characteristic shall be calculated from the following equation.					
	$\frac{(C_{85} - C_{20})}{C_{20} \times \Delta T} \times 10^6 \text{ (ppm/°C)} \quad \Delta T = 65$					
	Class 2					
	Capacitance at each step shall be measured in thermal equilibrium, and the temperature characteristic shall be calculated from the following equation.					
	Step	B	X5R, X7R, X6S, X7S, X7T			
	1	Minimum operating temperature				
	2	20°C	25°C			
	3	Maximum operating temperature				

▶ This catalog contains the typical specification only due to the limitation of space. When you consider the purchase of our products, please check our specification. For details of each product (characteristics graph, reliability information, precautions for use, and so on), see our Web site (<http://www.ty-top.com/>).

	$\frac{(C-C_2)}{C_2} \times 100(\%)$ <p>C : Capacitance in Step 1 or Step 3 C2 : Capacitance in Step 2</p>
--	--

9. Deflection

Specified Value	Temperature Compensating(Class1)	Standard	Appearance : No abnormality Capacitance change : Within $\pm 5\%$ or ± 0.5 pF, whichever is larger.
		High Frequency Type	Appearance : No abnormality Capacitance change : Within ± 0.5 pF
	High Permittivity (Class2)		Appearance : No abnormality Capacitance change : Within $\pm 12.5\%$ (BJ, B7, C6, C7, D7, LD(※)) Note: ※LD Low distortion high value multilayer ceramic capacitor

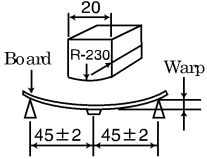
Test Methods and Remarks	<table border="1"> <tr> <th colspan="2">Multilayer Ceramic Capacitors</th> </tr> <tr> <td>042, 063, ※1 105 Type</td> <td>The other types</td> </tr> <tr> <td colspan="2">Board</td> </tr> <tr> <td colspan="2">Glass epoxy-resin substrate</td> </tr> <tr> <td>Thickness</td> <td>0.8mm / 1.6mm</td> </tr> <tr> <td>Warp</td> <td>1mm (Soft Termination type:3mm)</td> </tr> <tr> <td>Duration</td> <td>10 sec.</td> </tr> </table>		Multilayer Ceramic Capacitors		042, 063, ※1 105 Type	The other types	Board		Glass epoxy-resin substrate		Thickness	0.8mm / 1.6mm	Warp	1mm (Soft Termination type:3mm)	Duration	10 sec.	 <p>(Unit: mm)</p> <p>Capacitance measurement shall be conducted with the board bent</p>
	Multilayer Ceramic Capacitors																
042, 063, ※1 105 Type	The other types																
Board																	
Glass epoxy-resin substrate																	
Thickness	0.8mm / 1.6mm																
Warp	1mm (Soft Termination type:3mm)																
Duration	10 sec.																
<p>※1: 105 Type thickness, C: 0.2mm, P: 0.3mm.</p>																	

10. Body Strength

Specified Value	Temperature Compensating(Class1)	Standard	—
		High Frequency Type	No mechanical damage.
	High Permittivity (Class2)		—

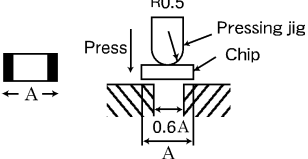
Test Methods and Remarks	<p>High Frequency Type Applied force : 5N Duration : 10 sec.</p> 
--------------------------	--

11. Adhesive Strength of Terminal Electrodes

Specified Value	Temperature Compensating(Class1)	Standard	No terminal separation or its indication.
		High Frequency Type	
	High Permittivity (Class2)		

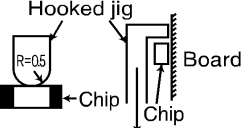
Test Methods and Remarks	<table border="1"> <tr> <th colspan="2">Multilayer Ceramic Capacitors</th> </tr> <tr> <td>042, 063 Type</td> <td>105 Type or more</td> </tr> <tr> <td>Applied force</td> <td>2N / 5N</td> </tr> <tr> <td>Duration</td> <td>30±5 sec.</td> </tr> </table>		Multilayer Ceramic Capacitors		042, 063 Type	105 Type or more	Applied force	2N / 5N	Duration	30±5 sec.	
	Multilayer Ceramic Capacitors										
	042, 063 Type	105 Type or more									
Applied force	2N / 5N										
Duration	30±5 sec.										

12. Solderability

Specified Value	Temperature Compensating(Class1)	Standard	At least 95% of terminal electrode is covered by new solder.
		High Frequency Type	
	High Permittivity (Class2)		

Test Methods and Remarks		Eutectic solder	Lead-free solder
	Solder type	H60A or H63A	Sn-3.0Ag-0.5Cu
	Solder temperature	230±5°C	245±3°C
	Duration	4±1 sec.	

▶ This catalog contains the typical specification only due to the limitation of space. When you consider the purchase of our products, please check our specification. For details of each product (characteristics graph, reliability information, precautions for use, and so on), see our Web site (<http://www.ty-top.com/>).

13. Resistance to Soldering

Specified Value	Temperature Compensating(Class1)	Standard	Appearance : No abnormality Capacitance change : Within $\pm 2.5\%$ or $\pm 0.25\text{pF}$, whichever is larger. Q : Initial value Insulation resistance : Initial value Withstanding voltage (between terminals) : No abnormality
		High Frequency Type	Appearance : No abnormality Capacitance change : Within $\pm 2.5\%$ Q : Initial value Insulation resistance : Initial value Withstanding voltage (between terminals) : No abnormality
	High Permittivity (Class2) Note 1		Appearance : No abnormality Capacitance change : Within $\pm 7.5\%$ (BJ, B7, C6, C7, D7, LD(※)) Dissipation factor : Initial value Insulation resistance : Initial value Withstanding voltage (between terminals) : No abnormality Note: ※LD Low distortion high value multilayer ceramic capacitor

Test Methods and Remarks	Class 1			
	042, 063 Type		105 Type	
	Preconditioning	None		
	Preheating	150°C, 1 to 2 min.	80 to 100°C, 2 to 5 min. 150 to 200°C, 2 to 5 min.	
	Solder temp.	270 \pm 5°C		
	Duration	3 \pm 0.5 sec.		
	Recovery	6 to 24 hrs (Standard condition) Note 5		
	Class 2			
	042, 063 Type		105, 107, 212 Type	316, 325 Type
	Preconditioning	Thermal treatment (at 150°C for 1 hr) Note 2		
	Preheating	150°C, 1 to 2 min.	80 to 100°C, 2 to 5 min. 150 to 200°C, 2 to 5 min.	80 to 100°C, 5 to 10 min. 150 to 200°C, 5 to 10 min.
	Solder temp.	270 \pm 5°C		
	Duration	3 \pm 0.5 sec.		
	Recovery	24 \pm 2 hrs (Standard condition) Note 5		

14. Temperature Cycle (Thermal Shock)

Specified Value	Temperature Compensating(Class1)	Standard	Appearance : No abnormality Capacitance change : Within $\pm 2.5\%$ or $\pm 0.25\text{pF}$, whichever is larger. Q : Initial value Insulation resistance : Initial value Withstanding voltage (between terminals) : No abnormality
		High Frequency Type	Appearance : No abnormality Capacitance change : Within $\pm 0.25\text{pF}$ Q : Initial value Insulation resistance : Initial value Withstanding voltage (between terminals) : No abnormality
	High Permittivity (Class2) Note 1		Appearance : No abnormality Capacitance change : Within $\pm 7.5\%$ (BJ, B7, C6, C7, D7, LD(※)) Dissipation factor : Initial value Insulation resistance : Initial value Withstanding voltage (between terminals) : No abnormality Note: ※LD Low distortion high value multilayer ceramic capacitor

Test Methods and Remarks	Class 1		Class 2		
	Preconditioning	None		Thermal treatment (at 150°C for 1 hr) Note 2	
	1 cycle	Step	Temperature (°C)	Time (min.)	
		1	Minimum operating temperature	30 \pm 3	
		2	Normal temperature	2 to 3	
		3	Maximum operating temperature	30 \pm 3	
4	Normal temperature	2 to 3			
Number of cycles	5 times				
Recovery	6 to 24 hrs (Standard condition) Note 5		24 \pm 2 hrs (Standard condition) Note 5		

▶ This catalog contains the typical specification only due to the limitation of space. When you consider the purchase of our products, please check our specification. For details of each product (characteristics graph, reliability information, precautions for use, and so on), see our Web site (<http://www.ty-top.com/>).

15. Humidity (Steady State)					
Specified Value	Temperature Compensating(Class1)	Standard	Appearance : No abnormality Capacitance change : Within $\pm 5\%$ or $\pm 0.5\text{pF}$, whichever is larger. Q : $C < 10\text{pF} : Q \geq 200 + 10C$ $10 \leq C < 30\text{pF} : Q \geq 275 + 2.5C$ $C \geq 30\text{pF} : Q \geq 350 (C : \text{Nominal capacitance})$ Insulation resistance : 1000 M Ω min.		
		High Frequency Type	Appearance : No abnormality Capacitance change : Within $\pm 0.5\text{pF}$, Insulation resistance : 1000 M Ω min.		
	High Permittivity (Class2) Note 1	Appearance : No abnormality Capacitance change : Within $\pm 12.5\%$ (BJ, B7, C6, C7, D7, LD(※)) Dissipation factor : 5.0% max. (BJ, B7, C6, C7, D7, LD(※)) Insulation resistance : 50 M Ω μF or 1000 M Ω whichever is smaller. Note: ※LD Low distortion high value multilayer ceramic capacitor			
Test Methods and Remarks		Class 1		Class 2	
		Standard	High Frequency Type	All items	
	Preconditioning	None			Thermal treatment (at 150°C for 1 hr) Note 2
	Temperature	40 \pm 2°C	60 \pm 2°C	40 \pm 2°C	
	Humidity	90 to 95%RH		90 to 95%RH	
	Duration	500 + 24 / - 0 hrs		500 + 24 / - 0 hrs	
	Recovery	6 to 24 hrs (Standard condition) Note 5		24 \pm 2 hrs (Standard condition) Note 5	

16. Humidity Loading					
Specified Value	Temperature Compensating(Class1)	Standard	Appearance : No abnormality Capacitance change : Within $\pm 7.5\%$ or $\pm 0.75\text{pF}$, whichever is larger. Q : $C < 30\text{pF} : Q \geq 100 + 10C/3$ $C \geq 30\text{pF} : Q \geq 200 (C : \text{Nominal capacitance})$ Insulation resistance : 500 M Ω min.		
		High Frequency Type	Appearance : No abnormality Capacitance change : $C \leq 2\text{pF} : \text{Within } \pm 0.4 \text{ pF}$ $C > 2\text{pF} : \text{Within } \pm 0.75 \text{ pF}$ (C : Nominal capacitance) Insulation resistance : 500 M Ω min.		
	High Permittivity (Class2) Note 1	Appearance : No abnormality Capacitance change : Within $\pm 12.5\%$ (BJ, B7, C6, C7, D7, LD(※)) Dissipation factor : 5.0% max. (BJ, B7, C6, C7, D7, LD(※)) Insulation resistance : 25 M Ω μF or 500 M Ω , whichever is smaller. Note: ※LD Low distortion high value multilayer ceramic capacitor			
Test Methods and Remarks		Class 1		Class 2	
		Standard	High Frequency Type	All items	
	Preconditioning	None			Voltage treatment (Rated voltage are applied for 1 hour at 40°C) Note 3
	Temperature	40 \pm 2°C	60 \pm 2°C	40 \pm 2°C	
	Humidity	90 to 95%RH		90 to 95%RH	
	Duration	500 + 24 / - 0 hrs		500 + 24 / - 0 hrs	
	Applied voltage	Rated voltage		Rated voltage	
	Charge/discharge current	50mA max.		50mA max.	
Recovery	6 to 24 hrs (Standard condition) Note 5		24 \pm 2 hrs (Standard condition) Note 5		

17. High Temperature Loading

Specified Value	Temperature Compensating (Class1)	Standard	Appearance : No abnormality Capacitance change : Within $\pm 3\%$ or $\pm 0.3\text{pF}$, whichever is larger. Q : $C < 10\text{pF}$: $Q \geq 200 + 10C$ $10 \leq C < 30\text{pF}$: $Q \geq 275 + 2.5C$ $C \geq 30\text{pF}$: $Q \geq 350$ (C: Nominal capacitance) Insulation resistance : 1000 M Ω min.
		High Frequency Type	Appearance : No abnormality Capacitance change : Within $\pm 3\%$ or $\pm 0.3\text{pF}$, whichever is larger. Insulation resistance : 1000 M Ω min.
	High Permittivity (Class2) Note 1		Appearance : No abnormality Capacitance change : Within $\pm 12.5\%$ (BJ, B7, C6, C7, D7, LD(※)) Dissipation factor : 5.0% max. (BJ, B7, C6, C7, D7, LD(※)) Insulation resistance : 50 M Ω μF or 1000 M Ω , whichever is smaller. Note: ※LD Low distortion high value multilayer ceramic capacitor

Test Methods and Remarks		Class 1		Class 2		
		Standard	High Frequency Type	BJ, LD(※)	C6	B7, C7, D7
	Preconditioning	None		Voltage treatment (Twice the rated voltage shall be applied for 1 hour at 85°C, 105°C or 125°C) Note 3, 4		
	Temperature	Maximum operating temperature		Maximum operating temperature		
	Duration	1000 + 48 / - 0 hrs		1000 + 48 / - 0 hrs		
	Applied voltage	Rated voltage $\times 2$		Rated voltage $\times 2$ Note 4		
	Charge/discharge current	50mA max.		50mA max.		
	Recovery	6 to 24hr (Standard condition) Note 5		24 \pm 2 hrs (Standard condition) Note 5		
Note: ※LD Low distortion high value multilayer ceramic capacitor						

Note 1 The figures indicate typical specifications. Please refer to individual specifications in detail.

Note 2 Thermal treatment : Initial value shall be measured after test sample is heat-treated at $150 \pm 0 / - 10^\circ\text{C}$ for an hour and kept at room temperature for 24 ± 2 hours.

Note 3 Voltage treatment : Initial value shall be measured after test sample is voltage-treated for an hour at both the temperature and voltage specified in the test conditions, and kept at room temperature for 24 ± 2 hours.

Note 4 150% of rated voltage is applicable to some items. Please refer to their specifications for further information.

Note 5 Standard condition: Temperature: 5 to 35°C, Relative humidity: 45 to 85 % RH, Air pressure: 86 to 106kPa When there are questions concerning measurement results, in order to provide correlation data, the test shall be conducted under the following condition.

Temperature: $20 \pm 2^\circ\text{C}$, Relative humidity: 60 to 70 % RH, Air pressure: 86 to 106kPa Unless otherwise specified, all the tests are conducted under the "standard condition".

Precautions on the use of Multilayer Ceramic Capacitors

PRECAUTIONS

1. Circuit Design

Precautions

- ◆ Verification of operating environment, electrical rating and performance
 1. A malfunction of equipment in fields such as medical, aerospace, nuclear control, etc. may cause serious harm to human life or have severe social ramifications. Therefore, any capacitors to be used in such equipment may require higher safety and reliability, and shall be clearly differentiated from them used in general purpose applications.
- ◆ Operating Voltage (Verification of Rated voltage)
 1. The operating voltage for capacitors must always be their rated voltage or less. If an AC voltage is loaded on a DC voltage, the sum of the two peak voltages shall be the rated voltage or less. For a circuit where an AC or a pulse voltage may be used, the sum of their peak voltages shall also be the rated voltage or less.
 2. Even if an applied voltage is the rated voltage or less reliability of capacitors may be deteriorated in case that either a high frequency AC voltage or a pulse voltage having rapid rise time is used in a circuit.

2. PCB Design

Precautions

- ◆ Pattern configurations (Design of Land-patterns)
 1. When capacitors are mounted on PCBs, the amount of solder used (size of fillet) can directly affect the capacitor performance. Therefore, the following items must be carefully considered in the design of land patterns:
 - (1) Excessive solder applied can cause mechanical stresses which lead to chip breaking or cracking. Therefore, please consider appropriate land-patterns for proper amount of solder.
 - (2) When more than one component are jointly soldered onto the same land, each component's soldering point shall be separated by solder-resist.
- ◆ Pattern configurations (Capacitor layout on PCBs)
 After capacitors are mounted on boards, they can be subjected to mechanical stresses in subsequent manufacturing processes (PCB cutting, board inspection, mounting of additional parts, assembly into the chassis, wave soldering of the boards, etc.). For this reason, land pattern configurations and positions of capacitors shall be carefully considered to minimize stresses.

Technical considerations

- ◆ Pattern configurations (Design of Land-patterns)
 The following diagrams and tables show some examples of recommended land patterns to prevent excessive solder amounts.
 - (1) Recommended land dimensions for typical chip capacitors
 - Multilayer Ceramic Capacitors : Recommended land dimensions (unit: mm)
 - Wave-soldering

Type	107	212	316	325
Size	L	1.6	2.0	3.2
	W	0.8	1.25	1.6
A	0.8 to 1.0	1.0 to 1.4	1.8 to 2.5	1.8 to 2.5
B	0.5 to 0.8	0.8 to 1.5	0.8 to 1.7	0.8 to 1.7
C	0.6 to 0.8	0.9 to 1.2	1.2 to 1.6	1.8 to 2.5

Land patterns for PCBs

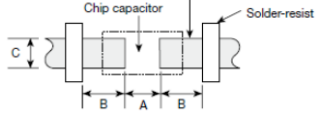

Chip capacitor

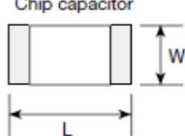

 - Reflow-soldering

Type	042	063	105	107	212	316	325	432
Size	L	0.4	0.6	1.0	1.6	2.0	3.2	4.5
	W	0.2	0.3	0.5	0.8	1.25	1.6	3.2
A	0.15 to 0.25	0.20 to 0.30	0.45 to 0.55	0.8 to 1.0	0.8 to 1.2	1.8 to 2.5	1.8 to 2.5	2.5 to 3.5
B	0.15 to 0.20	0.20 to 0.30	0.40 to 0.50	0.6 to 0.8	0.8 to 1.2	1.0 to 1.5	1.0 to 1.5	1.5 to 1.8
C	0.15 to 0.30	0.25 to 0.40	0.45 to 0.55	0.6 to 0.8	0.9 to 1.6	1.2 to 2.0	1.8 to 3.2	2.3 to 3.5

Note : Recommended land size might be different according to the allowance of the size of the product.

 - LWDC: Recommended land dimensions for reflow-soldering (unit: mm)

Type	105	107	212
Size	L	0.52	0.8
	W	1.0	1.6
A	0.18 to 0.22	0.25 to 0.3	0.5 to 0.7
B	0.2 to 0.25	0.3 to 0.4	0.4 to 0.5
C	0.9 to 1.1	1.5 to 1.7	1.9 to 2.1

LWDC

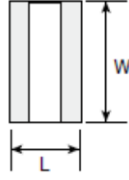

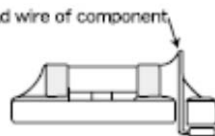
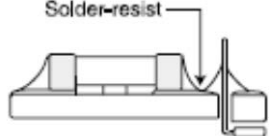
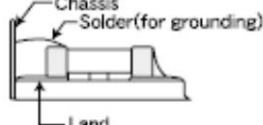
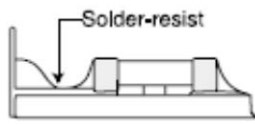
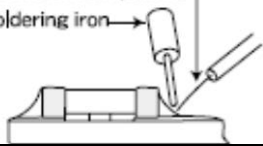
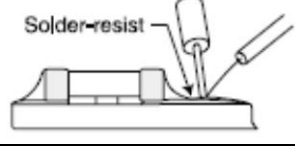
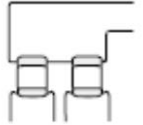
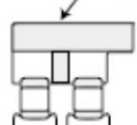

▶ This catalog contains the typical specification only due to the limitation of space. When you consider the purchase of our products, please check our specification. For details of each product (characteristics graph, reliability information, precautions for use, and so on), see our Web site (<http://www.ty-top.com/>) .

(2) Examples of good and bad solder application

Items	Not recommended	Recommended
Mixed mounting of SMD and leaded components		
Component placement close to the chassis		
Hand-soldering of leaded components near mounted components		
Horizontal component placement		

◆Pattern configurations (Capacitor layout on PCBs)

1-1. The following is examples of good and bad capacitor layouts ; capacitors shall be located to minimize any possible mechanical stresses from board warp or deflection.

Items	Not recommended	Recommended
Deflection of board		

Place the product at a right angle to the direction of the anticipated mechanical stress.

1-2. The amount of mechanical stresses given will vary depending on capacitor layout. Please refer to diagram below.

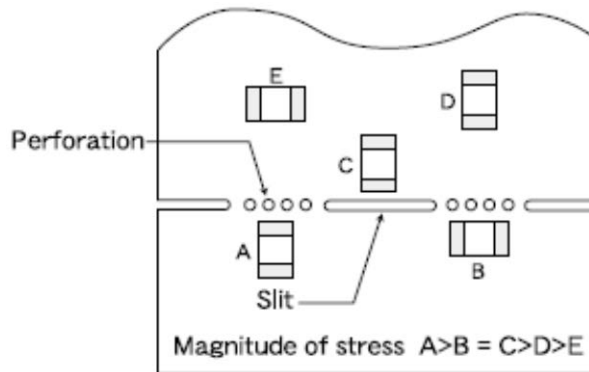

1-3. When PCB is split, the amount of mechanical stress on the capacitors can vary according to the method used. The following methods are listed in order from least stressful to most stressful: push-back, slit, V-grooving, and perforation. Thus, please consider the PCB, split methods as well as chip location.

3. Mounting

Precautions	<p>◆Adjustment of mounting machine</p> <ol style="list-style-type: none"> When capacitors are mounted on PCB, excessive impact load shall not be imposed on them. Maintenance and inspection of mounting machines shall be conducted periodically. <p>◆Selection of Adhesives</p> <ol style="list-style-type: none"> When chips are attached on PCBs with adhesives prior to soldering, it may cause capacitor characteristics degradation unless the following factors are appropriately checked : size of land patterns, type of adhesive, amount applied, hardening temperature and hardening period. Therefore, please contact us for further information.
Technical considerations	<p>◆Adjustment of mounting machine</p> <ol style="list-style-type: none"> When the bottom dead center of a pick-up nozzle is too low, excessive force is imposed on capacitors and causes damages. To avoid this, the following points shall be considerable. <ol style="list-style-type: none"> The bottom dead center of the pick-up nozzle shall be adjusted to the surface level of PCB without the board deflection. The pressure of nozzle shall be adjusted between 1 and 3 N static loads. To reduce the amount of deflection of the board caused by impact of the pick-up nozzle, supporting pins or back-up pins shall be used on the other side of the PCB. The following diagrams show some typical examples of good and bad pick-up nozzle placement:

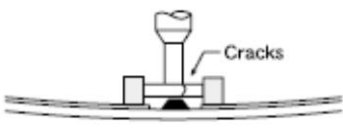
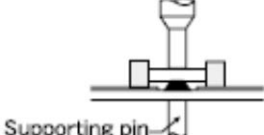
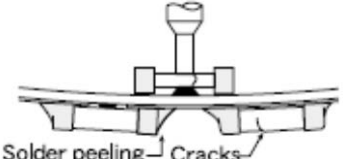
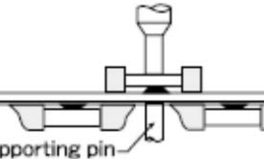
Items	Not recommended	Recommended
Single-sided mounting	 Cracks	 Supporting pin
Double-sided mounting	 Solder peeling—Cracks	 Supporting pin

2. As the alignment pin is worn out, adjustment of the nozzle height can cause chipping or cracking of capacitors because of mechanical impact on the capacitors.
To avoid this, the monitoring of the width between the alignment pins in the stopped position, maintenance, check and replacement of the pin shall be conducted periodically.

◆ Selection of Adhesives

Some adhesives may cause IR deterioration. The different shrinkage percentage of between the adhesive and the capacitors may result in stresses on the capacitors and lead to cracking. Moreover, too little or too much adhesive applied to the board may adversely affect components. Therefore, the following precautions shall be noted in the application of adhesives.

(1) Required adhesive characteristics

- The adhesive shall be strong enough to hold parts on the board during the mounting & solder process.
- The adhesive shall have sufficient strength at high temperatures.
- The adhesive shall have good coating and thickness consistency.
- The adhesive shall be used during its prescribed shelf life.
- The adhesive shall harden rapidly.
- The adhesive shall have corrosion resistance.
- The adhesive shall have excellent insulation characteristics.
- The adhesive shall have no emission of toxic gasses and no effect on the human body.

(2) The recommended amount of adhesives is as follows;

[Recommended condition]

Figure	212/316 case sizes as examples
a	0.3mm min
b	100 to 120 μ m
c	Adhesives shall not contact land

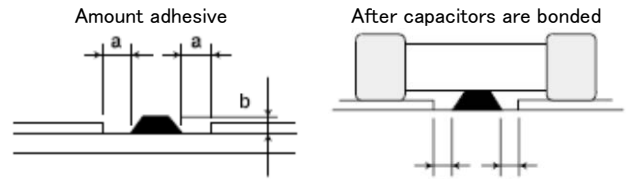

4. Soldering

◆ Selection of Flux

Since flux may have a significant effect on the performance of capacitors, it is necessary to verify the following conditions prior to use;

- Flux used shall be less than or equal to 0.1 wt% (in Cl equivalent) of halogenated content. Flux having a strong acidity content shall not be applied.
- When shall capacitors are soldered on boards, the amount of flux applied shall be controlled at the optimum level.
- When water-soluble flux is used, special care shall be taken to properly clean the boards.

Precautions

◆ Soldering

Temperature, time, amount of solder, etc. shall be set in accordance with their recommended conditions.
Sn-Zn solder paste can adversely affect MLCC reliability.
Please contact us prior to usage of Sn-Zn solder.

◆ Selection of Flux

- 1-1. When too much halogenated substance (Chlorine, etc.) content is used to activate flux, or highly acidic flux is used, it may lead to corrosion of terminal electrodes or degradation of insulation resistance on the surfaces of the capacitors.
- 1-2. Flux is used to increase solderability in wave soldering. However if too much flux is applied, a large amount of flux gas may be emitted and may adversely affect the solderability. To minimize the amount of flux applied, it is recommended to use a flux-bubbling system.
- 1-3. Since the residue of water-soluble flux is easily dissolved in moisture in the air, the residues on the surfaces of capacitors in high humidity conditions may cause a degradation of insulation resistance and reliability of the capacitors. Therefore, the cleaning methods and the capability of the machines used shall also be considered carefully when water-soluble flux is used.

Technical considerations

◆ Soldering

- Ceramic chip capacitors are susceptible to thermal shock when exposed to rapid or concentrated heating or rapid cooling.
- Therefore, the soldering must be conducted with great care so as to prevent malfunction of the components due to excessive thermal shock.
- Preheating : Capacitors shall be preheated sufficiently, and the temperature difference between the capacitors and solder shall be within 100 to 130°C.
- Cooling : The temperature difference between the capacitors and cleaning process shall not be greater than 100°C.

▶ This catalog contains the typical specification only due to the limitation of space. When you consider the purchase of our products, please check our specification.
For details of each product (characteristics graph, reliability information, precautions for use, and so on), see our Web site (<http://www.ty-top.com/>).

[Reflow soldering]

【Recommended conditions for eutectic soldering】

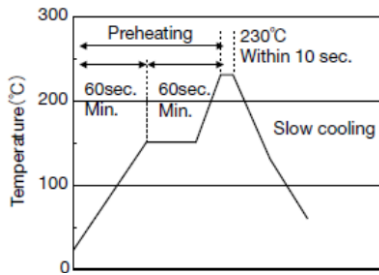

【Recommended condition for Pb-free soldering】

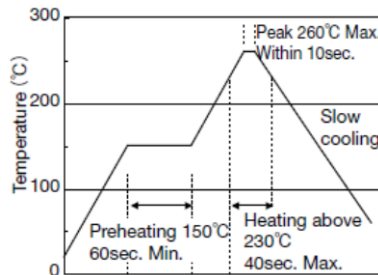

Caution

- ① The ideal condition is to have solder mass(fillet) controlled to 1/2 to 1/3 of the thickness of a capacitor.
- ② Because excessive dwell times can adversely affect solderability, soldering duration shall be kept as close to recommended times as possible.
- ③ Allowable number of reflow soldering : 2 times max.

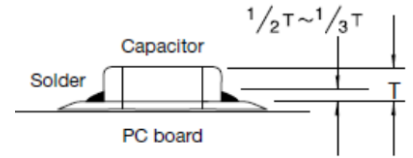

[Wave soldering]

【Recommended conditions for eutectic soldering】

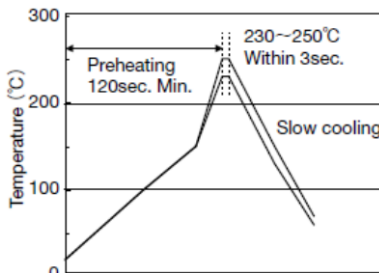

【Recommended condition for Pb-free soldering】

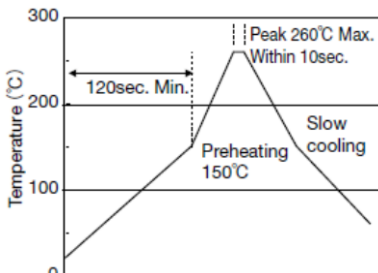

Caution

- ① Wave soldering must not be applied to capacitors designated as for reflow soldering only.
- ② Allowable number of wave soldering : 1 times max.

[Hand soldering]

【Recommended conditions for eutectic soldering】

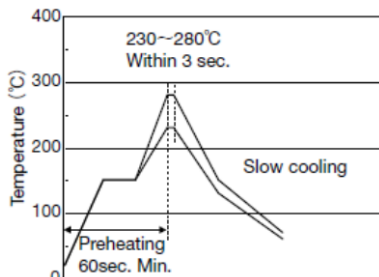

【Recommended condition for Pb-free soldering】

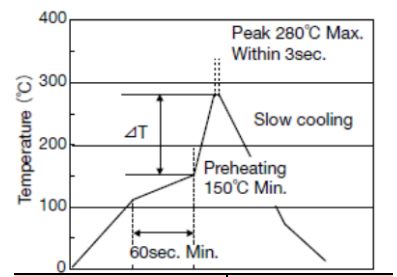
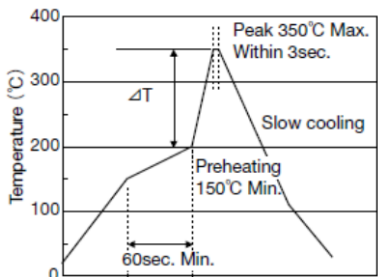

	ΔT
316type or less	$\Delta T \leq 150^\circ\text{C}$

	ΔT
325type or more	$\Delta T \leq 130^\circ\text{C}$

Caution

- ① Use a 50W soldering iron with a maximum tip diameter of 1.0 mm.
- ② The soldering iron shall not directly touch capacitors.
- ③ Allowable number of hand soldering : 1 times max.

5. Cleaning

Precautions	◆Cleaning conditions
	<ol style="list-style-type: none"> 1. When PCBs are cleaned after capacitors mounting, please select the appropriate cleaning solution in accordance with the intended use of the cleaning. (e.g. to remove soldering flux or other materials from the production process.) 2. Cleaning condition shall be determined after it is verified by using actual cleaning machine that the cleaning process does not affect capacitor's characteristics.
Technical considerations	<ol style="list-style-type: none"> 1. The use of inappropriate cleaning solutions can cause foreign substances such as flux residue to adhere to capacitors or deteriorate their outer coating, resulting in a degradation of the capacitor's electrical properties (especially insulation resistance). 2. Inappropriate cleaning conditions (insufficient or excessive cleaning) may adversely affect the performance of the capacitors. In the case of ultrasonic cleaning, too much power output can cause excessive vibration of PCBs which may lead to the cracking of capacitors or the soldered portion, or decrease the terminal electrodes' strength. Therefore, the following conditions shall be carefully checked; <ul style="list-style-type: none"> Ultrasonic output : 20 W/l or less Ultrasonic frequency : 40 kHz or less

▶ This catalog contains the typical specification only due to the limitation of space. When you consider the purchase of our products, please check our specification. For details of each product (characteristics graph, reliability information, precautions for use, and so on), see our Web site (<http://www.ty-top.com/>).

	Ultrasonic washing period : 5 min. or less
6. Resin coating and mold	
Precautions	<p>1. With some type of resins, decomposition gas or chemical reaction vapor may remain inside the resin during the hardening period or while left under normal storage conditions resulting in the deterioration of the capacitor's performance.</p> <p>2. When a resin's hardening temperature is higher than capacitor's operating temperature, the stresses generated by the excessive heat may lead to damage or destruction of capacitors. The use of such resins, molding materials etc. is not recommended.</p>
7. Handling	
Precautions	<p>◆Splitting of PCB</p> <p>1. When PCBs are split after components mounting, care shall be taken so as not to give any stresses of deflection or twisting to the board.</p> <p>2. Board separation shall not be done manually, but by using the appropriate devices.</p> <p>◆Mechanical considerations</p> <p>Be careful not to subject capacitors to excessive mechanical shocks.</p> <p>(1) If ceramic capacitors are dropped onto a floor or a hard surface, they shall not be used.</p> <p>(2) Please be careful that the mounted components do not come in contact with or bump against other boards or components.</p>
8. Storage conditions	
Precautions	<p>◆Storage</p> <p>1. To maintain the solderability of terminal electrodes and to keep packaging materials in good condition, care must be taken to control temperature and humidity in the storage area. Humidity should especially be kept as low as possible.</p> <p>•Recommended conditions</p> <p>Ambient temperature : Below 30°C Humidity : Below 70% RH</p> <p>The ambient temperature must be kept below 40°C. Even under ideal storage conditions, solderability of capacitor is deteriorated as time passes, so capacitors shall be used within 6 months from the time of delivery.</p> <p>•Ceramic chip capacitors shall be kept where no chlorine or sulfur exists in the air.</p> <p>2. The capacitance values of high dielectric constant capacitors will gradually decrease with the passage of time, so care shall be taken to design circuits. Even if capacitance value decreases as time passes, it will get back to the initial value by a heat treatment at 150°C for 1 hour.</p>
Technical considerations	If capacitors are stored in a high temperature and humidity environment, it might rapidly cause poor solderability due to terminal oxidation and quality loss of taping/package materials. For this reason, capacitors shall be used within 6 months from the time of delivery. If exceeding the above period, please check solderability before using the capacitors.
<p>※RCR-2335B (Safety Application Guide for fixed ceramic capacitors for use in electronic equipment) is published by JEITA. Please check the guide regarding precautions for deflection test, soldering by spot heat, and so on.</p>	