

## LMx19 High Speed Dual Comparator

### 1 Features

- Two Independent Comparators
- Operates from a Single 5-V Supply
- Typically 80-ns Response Time at  $\pm 15$  V
- Minimum Fan-out of 2 Each Side
- Maximum Input Current of 1  $\mu$ A Over Temperature
- Inputs and Outputs can be Isolated from System Ground
- High Common-Mode Slew Rate

### Connection Diagram

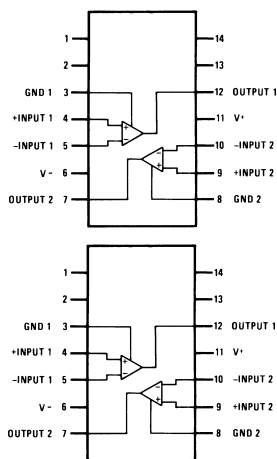

### Typical Application - Relay Driver

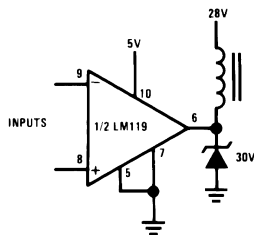

### 2 Description

The LM119 series are precision high-speed dual comparators fabricated on a single monolithic chip. They are designed to operate over a wide range of supply voltages down to a single 5-V logic supply and ground. They have higher gain and lower input currents than devices such as the LM710. The uncommitted collector of the output stage makes the LM119 compatible with RTL, DTL, and TTL, as well as capable of driving lamps and relays at currents of up to 25 mA.

The LM319A offers improved precision over the standard LM319, with tighter tolerances on offset voltage, offset current, and voltage gain.

Although designed primarily for applications requiring operation from digital logic supplies, the LM119 series are fully specified for power supplies up to  $\pm 15$  V. The series features faster response than the LM111, at the expense of higher power dissipation. However, the high-speed, wide operating voltage range and low package count make the LM119 more versatile than older devices such as the LM711.

The LM119 is specified from  $-55^{\circ}\text{C}$  to  $+125^{\circ}\text{C}$ , the LM219 is specified from  $-25^{\circ}\text{C}$  to  $+85^{\circ}\text{C}$ , and the LM319A and LM319 are specified from  $0^{\circ}\text{C}$  to  $+70^{\circ}\text{C}$ .

### Device Information<sup>(1)</sup>

PART NUMBER	PACKAGE	BODY SIZE (NOM)
LM119, LM219, LM319	TO-100 (10)	8.96 mm x 8.96 mm
	CDIP (14)	6.67 mm x 19.56 mm

(1) For all available packages, see the orderable addendum at the end of the data sheet.



## Table of Contents

<b>1 Features</b> .....	<b>1</b>	<b>6 Detailed Description</b> .....	<b>10</b>
<b>2 Description</b> .....	<b>1</b>	6.1 Functional Block Diagram .....	10
<b>3 Revision History</b> .....	<b>2</b>	<b>7 Application and Implementation</b> .....	<b>11</b>
<b>4 Pin Configuration and Functions</b> .....	<b>3</b>	7.1 Typical Applications .....	11
<b>5 Specifications</b> .....	<b>4</b>	<b>8 Device and Documentation Support</b> .....	<b>12</b>
5.1 Absolute Maximum Ratings .....	4	8.1 Related Links .....	12
5.2 ESD Ratings .....	4	8.2 Community Resources .....	12
5.3 Thermal Information .....	4	8.3 Trademarks .....	12
5.4 Electrical Characteristics LM119, LM219 .....	5	8.4 Electrostatic Discharge Caution .....	12
5.5 Electrical Characteristics LM319, LM319A .....	6	8.5 Glossary .....	12
5.6 Typical Characteristics .....	7	<b>9 Mechanical, Packaging, and Orderable Information</b> .....	<b>12</b>

## 3 Revision History

<b>Changes from Revision A (May 2004) to Revision B</b>	<b>Page</b>
• Changed datasheet to new TI format from National. ....	1
• Added <i>Pin Functions</i> and <i>Thermal Information</i> tables, the <i>Device and Documentation Support</i> section, and <i>Mechanical, Packaging, and Orderable Information</i> section .....	1

## 4 Pin Configuration and Functions

**D, J, or NFF Package  
14-Pins CDIP and PDIP  
Top View**

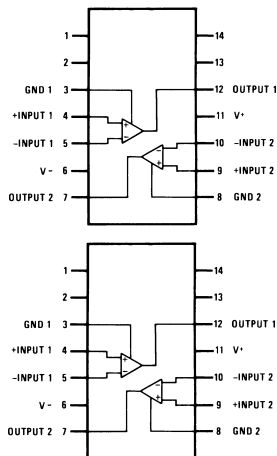

**LME Package  
10-Pins TO-100 (Metal Can Package)  
Top View**

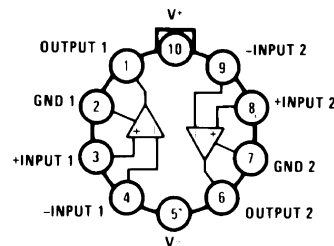

**NAD Package  
10-Pins CFP  
Top View**

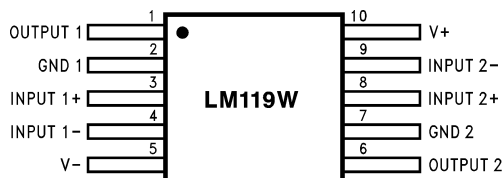

### Pin Functions

NAME	PIN			I/O	DESCRIPTION
	NO. (D, J, NFF 14)	NO. (LME 10)	NO. (NAD 10)		
OUTPUT 1	1	12	1	O	Comparator 1 output
GND 1	2	3	2	G	Comparator 1 ground connection
INPUT 1+	3	4	3	I	Comparator 1 input
INPUT 1-	4	5	4	I	Comparator 1 input
V-	5	6	5	P	Negative supply voltage
OUTPUT 2	6	7	6	O	Comparator 2 output
GND 2	7	8	7	G	Comparator 2 ground connection
INPUT 2+	8	9	8	I	Comparator 2 input
INPUT 2-	9	10	9	I	Comparator 2 input
V+	10	11	10	P	Positive supply voltage
NC	1,2,13,14				No connect. Do not connect to ground.

## 5 Specifications

### 5.1 Absolute Maximum Ratings

 over operating free-air temperature range (unless otherwise noted)<sup>(1)(2)(3)</sup>

		MIN	MAX	UNIT
Total supply voltage			36	V
Output to negative supply voltage			36	V
Ground to negative supply voltage			25	V
Ground to positive supply voltage			18	V
Differential input voltage		-5	+5	V
Input voltage <sup>(4)</sup>		-15	+15	V
Power dissipation <sup>(5)</sup>			500	mW
Output short circuit duration			10	sec
Lead temperature (soldering, 10 sec.)			260	°C
Soldering information <sup>(6)</sup>	Dual-In-Line Package Soldering (10 seconds)		260	°C
	Small Outline Package Vapor Phase (60 seconds)		215	
	Small Outline Package Infrared (15 seconds)		220	
Operating temperature	LM119	-55	125	°C
	LM219	-25	85	
	LM319A, LM319	0	70	
Storage temperature, T <sub>stg</sub>		-65	150	°C

- Stresses beyond those listed under *Absolute Maximum Ratings* may cause permanent damage to the device. These are stress ratings only, which do not imply functional operation of the device at these or any other conditions beyond those indicated under *Recommended Operating Conditions*. Exposure to absolute-maximum-rated conditions for extended periods may affect device reliability.
- If Military/Aerospace specified devices are required, please contact the Texas Instruments Sales Office/ Distributors for availability and specifications.
- Refer to RETS119X for LM119H/883 and LM119J/883 specifications.
- For supply voltages less than  $\pm 15$  V the absolute maximum input voltage is equal to the supply voltage.
- The maximum junction temperature of the LM119 is 150°C, while that of the LM219 is 110°C. For operating at elevated temperatures, devices in the H10 package must be derated based on a thermal resistance of 160°C/W, junction to ambient, or 19°C/W, junction to case. The thermal resistance of the J14 and N14 packages is 100°C/W, junction to ambient.
- See AN-450 "Surface Mounting Methods and Their Effect on Product Reliability" for other methods of soldering surface mount devices.

### 5.2 ESD Ratings

			VALUE	UNIT
V <sub>(ESD)</sub>	Electrostatic discharge	Human body model (HBM), per ANSI/ESDA/JEDEC JS-001 <sup>(1)</sup>	±800	V

- JEDEC document JEP155 states that 500-V HBM allows safe manufacturing with a standard ESD control process.

### 5.3 Thermal Information

THERMAL METRIC <sup>(1)</sup>	LM119, LM219, LM319			UNIT	
	TO-100 (LME)	PDIP (NFF)	CDIP (J)		
	10 PINS	14 PINS	14 PINS		
R <sub>θJA</sub>	Junction-to-ambient thermal resistance	160	100	100	°C/W
R <sub>θJC(top)</sub>	Junction-to-case (top) thermal resistance	19	NA	NA	°C/W

- For more information about traditional and new thermal metrics, see the *Semiconductor and IC Package Thermal Metrics* application report, [SPRA953](#).

## 5.4 Electrical Characteristics LM119, LM219

These specifications apply for  $V_S = \pm 15\text{ V}$ , and the Ground pin at ground, and  $-55^\circ\text{C} \leq T_A \leq +125^\circ\text{C}$ , unless otherwise stated. With the LM219, all temperature specifications are limited to  $-25^\circ\text{C} \leq T_A \leq +85^\circ\text{C}$ . The offset voltage, offset current and bias current specifications apply for any supply voltage from a single 5-V supply up to  $\pm 15\text{-V}$  supplies. Do not operate the device with more than 16 V from ground to  $V_S$ .

PARAMETER	TEST CONDITIONS	MIN	TYP	MAX	UNIT
Input Offset Voltage <sup>(1)</sup>	$T_A = 25^\circ\text{C}$ , $R_S \leq 5\text{k}$		0.7	4	mV
Input Offset Current <sup>(1)</sup>	$T_A = 25^\circ\text{C}$		30	75	nA
Input Bias Current	$T_A = 25^\circ\text{C}$		150	500	nA
Voltage Gain	$T_A = 25^\circ\text{C}$ <sup>(2)</sup>	10	40		V/mV
Response Time <sup>(3)</sup>	$T_A = 25^\circ\text{C}$ , $V_S = \pm 15\text{ V}$		80		ns
Saturation Voltage	$V_{IN} \leq -5\text{ mV}$ , $I_{OUT} = 25\text{ mA}$ $T_A = 25^\circ\text{C}$		0.75	1.5	V
Output Leakage Current	$V_{IN} \geq 5\text{ mV}$ , $V_{OUT} = 35\text{ V}$ $T_A = 25^\circ\text{C}$		0.2	2	$\mu\text{A}$
Input Offset Voltage <sup>(1)</sup>	$R_S \leq 5\text{k}$			7	mV
Input Offset Current <sup>(1)</sup>				100	nA
Input Bias Current				1000	nA
Input Voltage Range	$V_S = \pm 15\text{ V}$	-12	$\pm 13$	+12	V
	$V^+ = 5\text{ V}$ , $V^- = 0$	1		3	
Saturation Voltage	$V^+ \geq 4.5\text{ V}$ , $V^- = 0$ $V_{IN} \leq -6\text{ mV}$ , $I_{SINK} \leq 3.2\text{ mA}$ $T_A \geq 0^\circ\text{C}$		0.23	0.4	V
	$T_A \leq 0^\circ\text{C}$			0.6	
Output Leakage Current	$V_{IN} \geq 5\text{ mV}$ , $V_{OUT} = 35\text{ V}$ , $V^- = V_{GND} = 0\text{ V}$		1	10	$\mu\text{A}$
Differential Input Voltage				$\pm 5$	V
Positive Supply Current	$T_A = 25^\circ\text{C}$ , $V^+ = 5\text{ V}$ , $V^- = 0$		4.3		mA
Positive Supply Current	$T_A = 25^\circ\text{C}$ , $V_S = \pm 15\text{ V}$		8	11.5	mA
Negative Supply Current	$T_A = 25^\circ\text{C}$ , $V_S = \pm 15\text{ V}$		3	4.5	mA

- (1) The offset voltages and offset currents given are the maximum values required to drive the output within a volt of either supply with a 1-mA load. Thus, these parameters define an error band and take into account the worst case effects of voltage gain and input impedance.
- (2) Output is pulled up to 15 V through a 1.4-kW resistor.
- (3) The response time specified is for a 100-mV input step with 5-mV overdrive.

## 5.5 Electrical Characteristics LM319, LM319A

These specifications apply for  $V_S = \pm 15\text{ V}$ , and  $0^\circ\text{C} \leq T_A \leq 70^\circ\text{C}$ , unless otherwise stated. The offset voltage, offset current, and bias current specifications apply for any supply voltage from a single 5-V supply up to  $\pm 15\text{-V}$  supplies. Do not operate the device with more than 16 V from ground to  $V_S$ .

PARAMETER	TEST CONDITIONS	LM319A			LM319			UNIT
		MIN	TYP	MAX	MIN	TYP	MAX	
Input Offset Voltage <sup>(1)</sup>	$T_A = 25^\circ\text{C}$ , $R_S \leq 5\text{ k}$		0.5	1		2	8	mV
Input Offset Current <sup>(1)</sup>	$T_A = 25^\circ\text{C}$		20	40		80	200	nA
Input Bias Current	$T_A = 25^\circ\text{C}$		150	500		250	1000	nA
Voltage Gain	$T_A = 25^\circ\text{C}$ <sup>(2)</sup>	20	40		8	40		V/mV
Response Time <sup>(3)</sup>	$T_A = 25^\circ\text{C}$ , $V_S = \pm 15\text{ V}$		80			80		ns
Saturation Voltage	$V_{IN} \leq -10\text{ mV}$ , $I_{OUT} = 25\text{ mA}$ $T_A = 25^\circ\text{C}$		0.75	1.5		0.75	1.5	V
Output Leakage Current	$V_{IN} \geq 10\text{ mV}$ , $V_{OUT} = 35\text{ V}$ $V^- = V_{GND} = 0\text{ V}$ , $T_A = 25^\circ\text{C}$		0.2	10		0.2	10	$\mu\text{A}$
Input Offset Voltage <sup>(1)</sup>	$R_S \leq 5\text{ k}$			10			10	mV
Input Offset Current <sup>(1)</sup>				300			300	nA
Input Bias Current				1000			1200	nA
Input Voltage Range	$V_S = \pm 15\text{ V}$		$\pm 13$			$\pm 13$		V
	$V^+ = 5\text{ V}$ , $V^- = 0$	1		3	1		3	
Saturation Voltage	$V^+ \geq 4.5\text{ V}$ , $V^- = 0$ $V_{IN} \leq -10\text{ mV}$ , $I_{SINK} \leq 3.2\text{ mA}$		0.3	0.4		0.3	0.4	V
Differential Input Voltage			$\pm 5$			$\pm 5$		V
Positive Supply Current	$T_A = 25^\circ\text{C}$ , $V^+ = 5\text{ V}$ , $V^- = 0$		4.3			4.3		mA
Positive Supply Current	$T_A = 25^\circ\text{C}$ , $V_S = \pm 15\text{ V}$		8	12.5		8	12.5	mA
Negative Supply Current	$T_A = 25^\circ\text{C}$ , $V_S = \pm 15\text{ V}$		3	5		3	5	mA

- (1) The offset voltages and offset currents given are the maximum values required to drive the output within a volt of either supply with a 1-mA load. Thus, these parameters define an error band and take into account the worst case effects of voltage gain and input impedance.
- (2) Output is pulled up to 15 V through a 1.4-kW resistor.
- (3) The response time specified is for a 100-mV input step with 5-mV overdrive.

## 5.6 Typical Characteristics

### 5.6.1 Typical Characteristics – LM119, LM119A, LM219

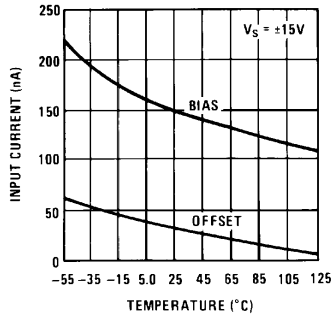

Figure 1. Input Currents

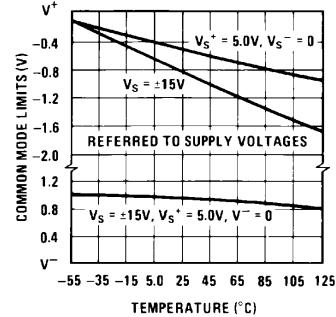

Figure 2. Common-Mode Limits

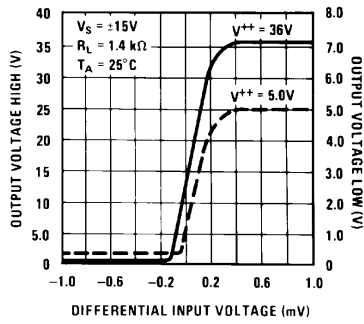

Figure 3. Transfer Function

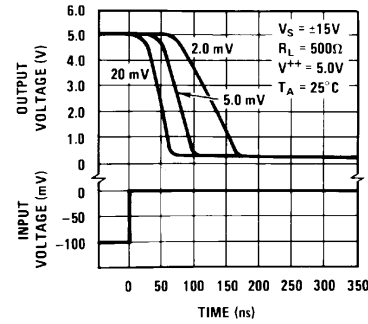

Figure 4. Response Time for Various Input Overdrives

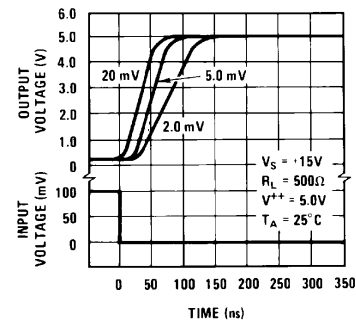

Figure 5. Response Time for Various Input Overdrives

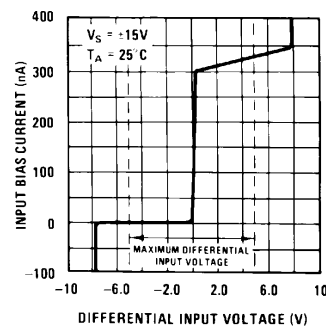

Figure 6. Input Characteristics

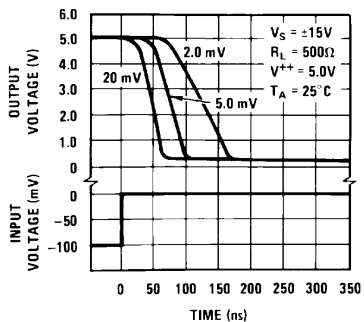

Figure 7. Response Time for Various Input Overdrives

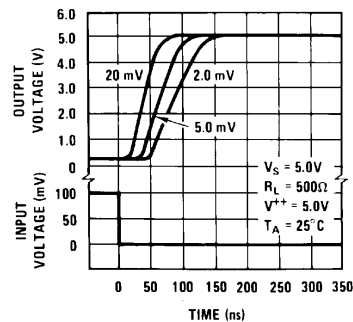

Figure 8. Response Time for Various Input Overdrives

Typical Characteristics – LM119, LM119A, LM219 (continued)

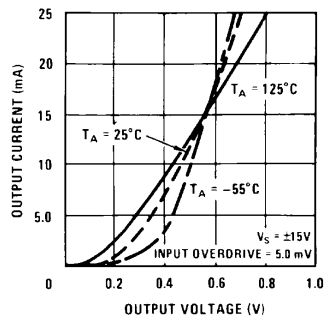

Figure 9. Output Saturation Voltage

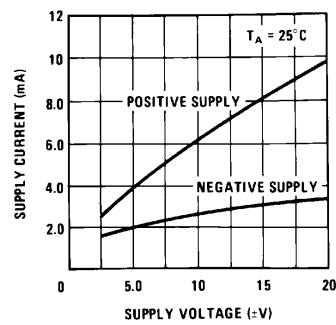

Figure 10. Supply Current

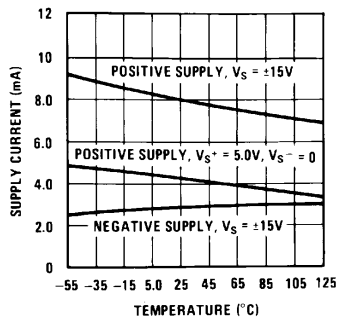

Figure 11. Supply Current

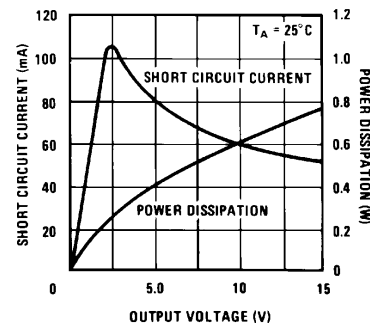

Figure 12. Output Limiting Characteristics

5.6.2 Typical Characteristics – LM319, LM319A

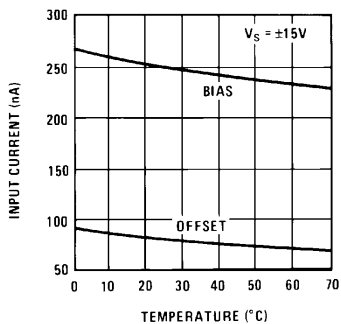

Figure 13. Input Currents

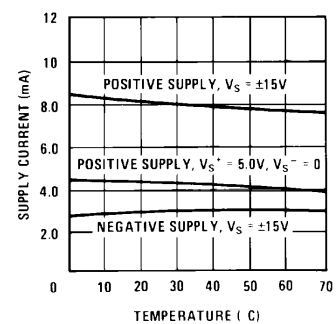

Figure 14. Supply Currents

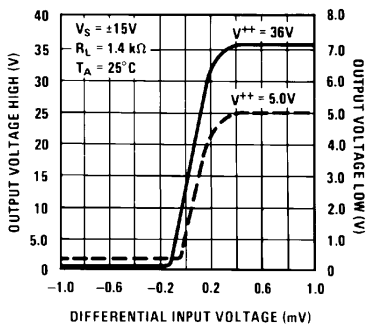

Figure 15. Transfer Function

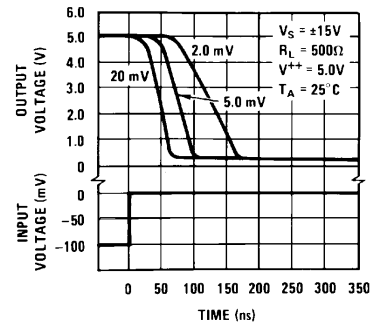

Figure 16. Response Time for Various Input Overdrives



Typical Characteristics – LM319, LM319A (continued)

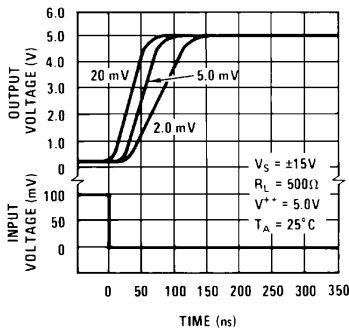

Figure 17. Response Time for Various Input Overdrives

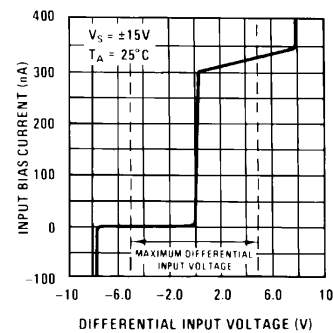

Figure 18. Input Characteristics

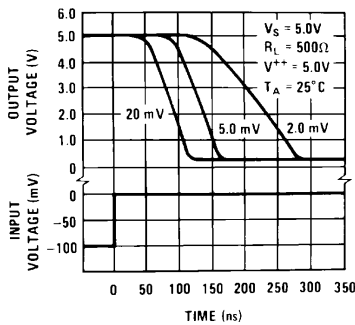

Figure 19. Response Time for Various Input Overdrives

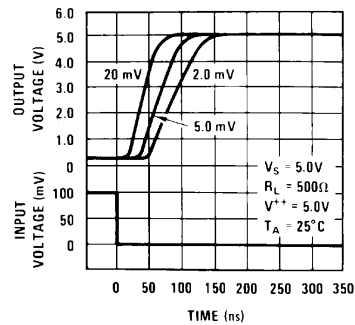

Figure 20. Response Time for Various Input Overdrives

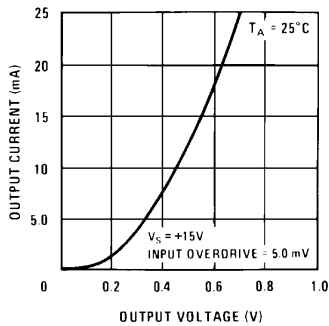

Figure 21. Output Saturation Voltage

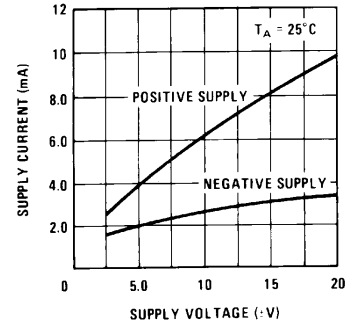

Figure 22. Supply Current

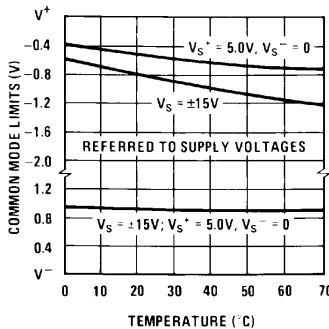

Figure 23. Common-Mode Limits

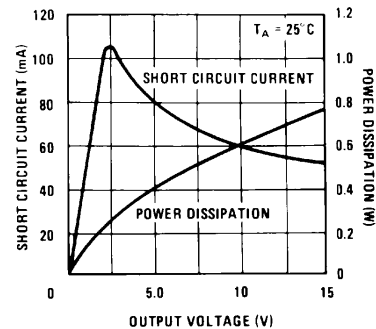
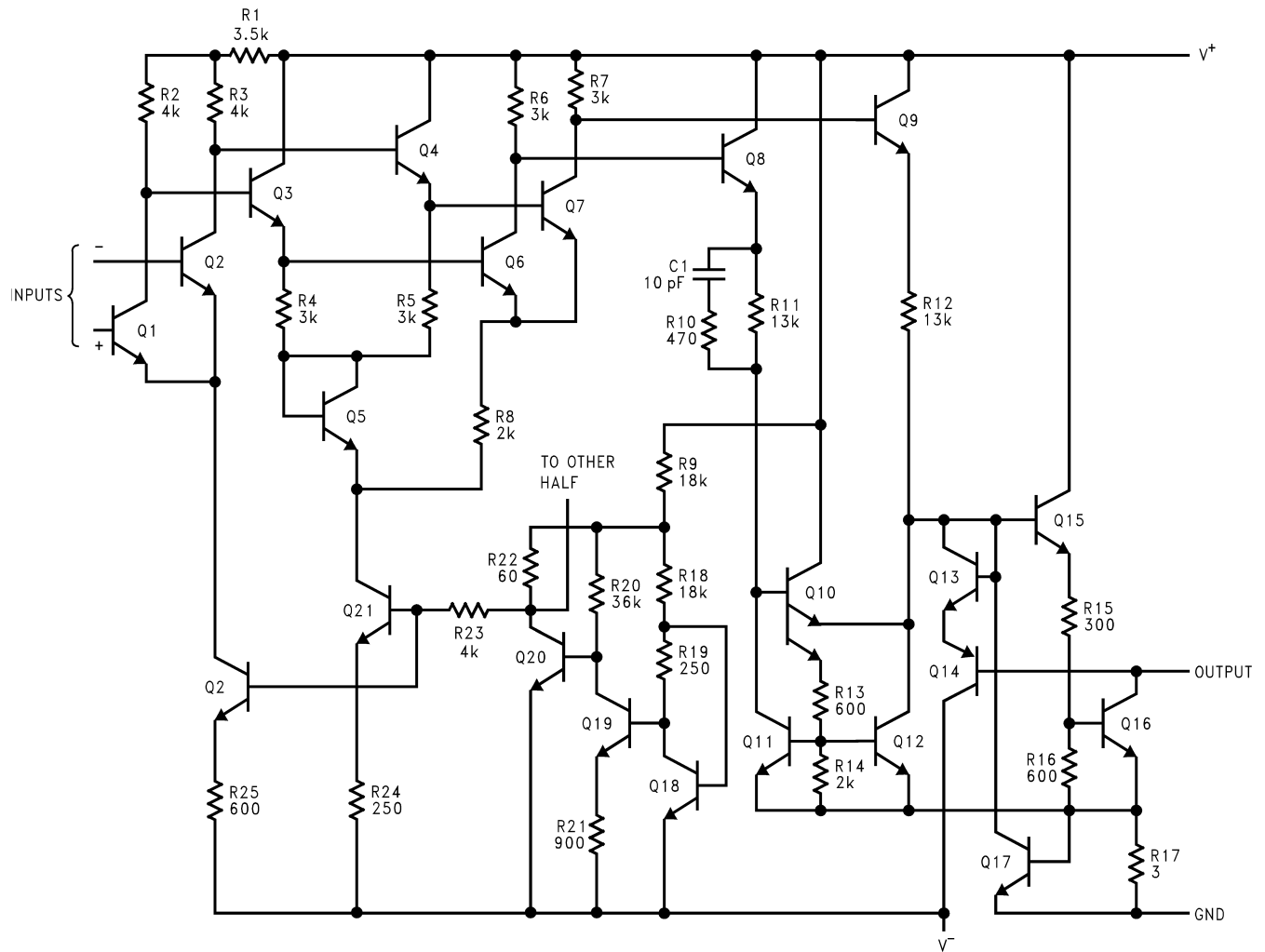

Figure 24. Output Limiting Characteristics

## 6 Detailed Description

### 6.1 Functional Block Diagram



DS005705-1

\*Do not operate the LM119 with more than 16V between GND and  $V^+$

## 7 Application and Implementation

### NOTE

Information in the following applications sections is not part of the TI component specification, and TI does not warrant its accuracy or completeness. TI's customers are responsible for determining suitability of components for their purposes. Customers should validate and test their design implementation to confirm system functionality.

### 7.1 Typical Applications

#### 7.1.1 Relay Driver

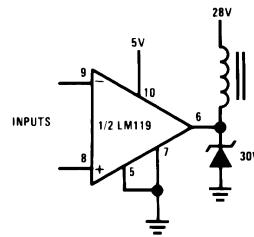

Figure 25. Relay Driver

#### 7.1.2 Window Detector

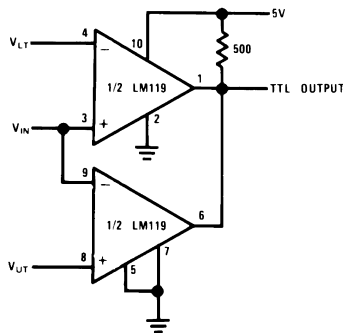

Figure 26. Window Detector

## 8 Device and Documentation Support

### 8.1 Related Links

The table below lists quick access links. Categories include technical documents, support and community resources, tools and software, and quick access to sample or buy.

**Table 1. Related Links**

PARTS	PRODUCT FOLDER	SAMPLE & BUY	TECHNICAL DOCUMENTS	TOOLS & SOFTWARE	SUPPORT & COMMUNITY
LM119	<a href="#">Click here</a>	<a href="#">Click here</a>	<a href="#">Click here</a>	<a href="#">Click here</a>	<a href="#">Click here</a>
LM219	<a href="#">Click here</a>	<a href="#">Click here</a>	<a href="#">Click here</a>	<a href="#">Click here</a>	<a href="#">Click here</a>
LM319	<a href="#">Click here</a>	<a href="#">Click here</a>	<a href="#">Click here</a>	<a href="#">Click here</a>	<a href="#">Click here</a>

### 8.2 Community Resources

The following links connect to TI community resources. Linked contents are provided "AS IS" by the respective contributors. They do not constitute TI specifications and do not necessarily reflect TI's views; see TI's [Terms of Use](#).

**TI E2E™ Online Community** *TI's Engineer-to-Engineer (E2E) Community*. Created to foster collaboration among engineers. At [e2e.ti.com](http://e2e.ti.com), you can ask questions, share knowledge, explore ideas and help solve problems with fellow engineers.

**Design Support** *TI's Design Support* Quickly find helpful E2E forums along with design support tools and contact information for technical support.

### 8.3 Trademarks

E2E is a trademark of Texas Instruments.

All other trademarks are the property of their respective owners.

### 8.4 Electrostatic Discharge Caution



These devices have limited built-in ESD protection. The leads should be shorted together or the device placed in conductive foam during storage or handling to prevent electrostatic damage to the MOS gates.

### 8.5 Glossary

[SLYZ022](#) — *TI Glossary*.

This glossary lists and explains terms, acronyms, and definitions.

## 9 Mechanical, Packaging, and Orderable Information

The following pages include mechanical, packaging, and orderable information. This information is the most current data available for the designated devices. This data is subject to change without notice and revision of this document. For browser-based versions of this data sheet, refer to the left-hand navigation.

**PACKAGING INFORMATION**

Orderable Device	Status (1)	Package Type	Package Drawing	Pins	Package Qty	Eco Plan (2)	Lead/Ball Finish (6)	MSL Peak Temp (3)	Op Temp (°C)	Device Marking (4/5)	Samples
LM119H	ACTIVE	TO-100	LME	10	500	TBD	Call TI	Call TI	-55 to 125	( LM119H ~ LM119H)	<a href="#">Samples</a>
LM119H/NOPB	ACTIVE	TO-100	LME	10	500	Green (RoHS & no Sb/Br)	Call TI	Level-1-NA-UNLIM	-55 to 125	( LM119H ~ LM119H)	<a href="#">Samples</a>
LM119J	ACTIVE	CDIP	J	14	25	TBD	Call TI	Call TI	-55 to 125	LM119J	<a href="#">Samples</a>
LM319AM	NRND	SOIC	D	14	55	TBD	Call TI	Call TI	0 to 70	LM319AM	
LM319AM/NOPB	ACTIVE	SOIC	D	14	55	Green (RoHS & no Sb/Br)	CU SN	Level-1-260C-UNLIM	0 to 70	LM319AM	<a href="#">Samples</a>
LM319AMX	NRND	SOIC	D	14		TBD	Call TI	Call TI	0 to 70	LM319AM	
LM319AMX/NOPB	ACTIVE	SOIC	D	14	2500	Green (RoHS & no Sb/Br)	CU SN	Level-1-260C-UNLIM	0 to 70	LM319AM	<a href="#">Samples</a>
LM319M	NRND	SOIC	D	14	55	TBD	Call TI	Call TI	0 to 70	LM319M	
LM319M/NOPB	ACTIVE	SOIC	D	14	55	Green (RoHS & no Sb/Br)	CU SN	Level-1-260C-UNLIM	0 to 70	LM319M	<a href="#">Samples</a>
LM319MX	NRND	SOIC	D	14		TBD	Call TI	Call TI	0 to 70	LM319M	
LM319MX/NOPB	ACTIVE	SOIC	D	14	2500	Green (RoHS & no Sb/Br)	CU SN	Level-1-260C-UNLIM	0 to 70	LM319M	<a href="#">Samples</a>
LM319N/NOPB	ACTIVE	PDIP	NFF	14	25	Green (RoHS & no Sb/Br)	CU SN	Level-1-NA-UNLIM	0 to 70	LM319N	<a href="#">Samples</a>

(1) The marketing status values are defined as follows:

**ACTIVE:** Product device recommended for new designs.

**LIFEBUY:** TI has announced that the device will be discontinued, and a lifetime-buy period is in effect.

**NRND:** Not recommended for new designs. Device is in production to support existing customers, but TI does not recommend using this part in a new design.

**PREVIEW:** Device has been announced but is not in production. Samples may or may not be available.

**OBSOLETE:** TI has discontinued the production of the device.

(2) Eco Plan - The planned eco-friendly classification: Pb-Free (RoHS), Pb-Free (RoHS Exempt), or Green (RoHS & no Sb/Br) - please check <http://www.ti.com/productcontent> for the latest availability information and additional product content details.

**TBD:** The Pb-Free/Green conversion plan has not been defined.

**Pb-Free (RoHS):** TI's terms "Lead-Free" or "Pb-Free" mean semiconductor products that are compatible with the current RoHS requirements for all 6 substances, including the requirement that lead not exceed 0.1% by weight in homogeneous materials. Where designed to be soldered at high temperatures, TI Pb-Free products are suitable for use in specified lead-free processes.

**Pb-Free (RoHS Exempt):** This component has a RoHS exemption for either 1) lead-based flip-chip solder bumps used between the die and package, or 2) lead-based die adhesive used between the die and leadframe. The component is otherwise considered Pb-Free (RoHS compatible) as defined above.

**Green (RoHS & no Sb/Br):** TI defines "Green" to mean Pb-Free (RoHS compatible), and free of Bromine (Br) and Antimony (Sb) based flame retardants (Br or Sb do not exceed 0.1% by weight in homogeneous material)

- (3) MSL, Peak Temp. - The Moisture Sensitivity Level rating according to the JEDEC industry standard classifications, and peak solder temperature.
- (4) There may be additional marking, which relates to the logo, the lot trace code information, or the environmental category on the device.
- (5) Multiple Device Markings will be inside parentheses. Only one Device Marking contained in parentheses and separated by a "~" will appear on a device. If a line is indented then it is a continuation of the previous line and the two combined represent the entire Device Marking for that device.
- (6) Lead/Ball Finish - Orderable Devices may have multiple material finish options. Finish options are separated by a vertical ruled line. Lead/Ball Finish values may wrap to two lines if the finish value exceeds the maximum column width.

**Important Information and Disclaimer:**The information provided on this page represents TI's knowledge and belief as of the date that it is provided. TI bases its knowledge and belief on information provided by third parties, and makes no representation or warranty as to the accuracy of such information. Efforts are underway to better integrate information from third parties. TI has taken and continues to take reasonable steps to provide representative and accurate information but may not have conducted destructive testing or chemical analysis on incoming materials and chemicals. TI and TI suppliers consider certain information to be proprietary, and thus CAS numbers and other limited information may not be available for release.

In no event shall TI's liability arising out of such information exceed the total purchase price of the TI part(s) at issue in this document sold by TI to Customer on an annual basis.

**TAPE AND REEL INFORMATION**

**QUADRANT ASSIGNMENTS FOR PIN 1 ORIENTATION IN TAPE**

\*All dimensions are nominal

Device	Package Type	Package Drawing	Pins	SPQ	Reel Diameter (mm)	Reel Width W1 (mm)	A0 (mm)	B0 (mm)	K0 (mm)	P1 (mm)	W (mm)	Pin1 Quadrant
LM319AMX/NOPB	SOIC	D	14	2500	330.0	16.4	6.5	9.35	2.3	8.0	16.0	Q1
LM319MX/NOPB	SOIC	D	14	2500	330.0	16.4	6.5	9.35	2.3	8.0	16.0	Q1

**TAPE AND REEL BOX DIMENSIONS**

\*All dimensions are nominal

Device	Package Type	Package Drawing	Pins	SPQ	Length (mm)	Width (mm)	Height (mm)
LM319AMX/NOPB	SOIC	D	14	2500	367.0	367.0	35.0
LM319MX/NOPB	SOIC	D	14	2500	367.0	367.0	35.0



J (R-GDIP-T\*\*)

14 LEADS SHOWN

CERAMIC DUAL IN-LINE PACKAGE



DIM \ PINS **	14	16	18	20
A	0.300 (7,62) BSC	0.300 (7,62) BSC	0.300 (7,62) BSC	0.300 (7,62) BSC
B MAX	0.785 (19,94)	.840 (21,34)	0.960 (24,38)	1.060 (26,92)
B MIN	—	—	—	—
C MAX	0.300 (7,62)	0.300 (7,62)	0.310 (7,87)	0.300 (7,62)
C MIN	0.245 (6,22)	0.245 (6,22)	0.220 (5,59)	0.245 (6,22)



4040083/F 03/03

- NOTES:
- All linear dimensions are in inches (millimeters).
  - This drawing is subject to change without notice.
  - This package is hermetically sealed with a ceramic lid using glass frit.
  - Index point is provided on cap for terminal identification only on press ceramic glass frit seal only.
  - Falls within MIL STD 1835 GDIP1-T14, GDIP1-T16, GDIP1-T18 and GDIP1-T20.

LME (O-MBCY-W10)

METAL CYLINDRICAL PACKAGE

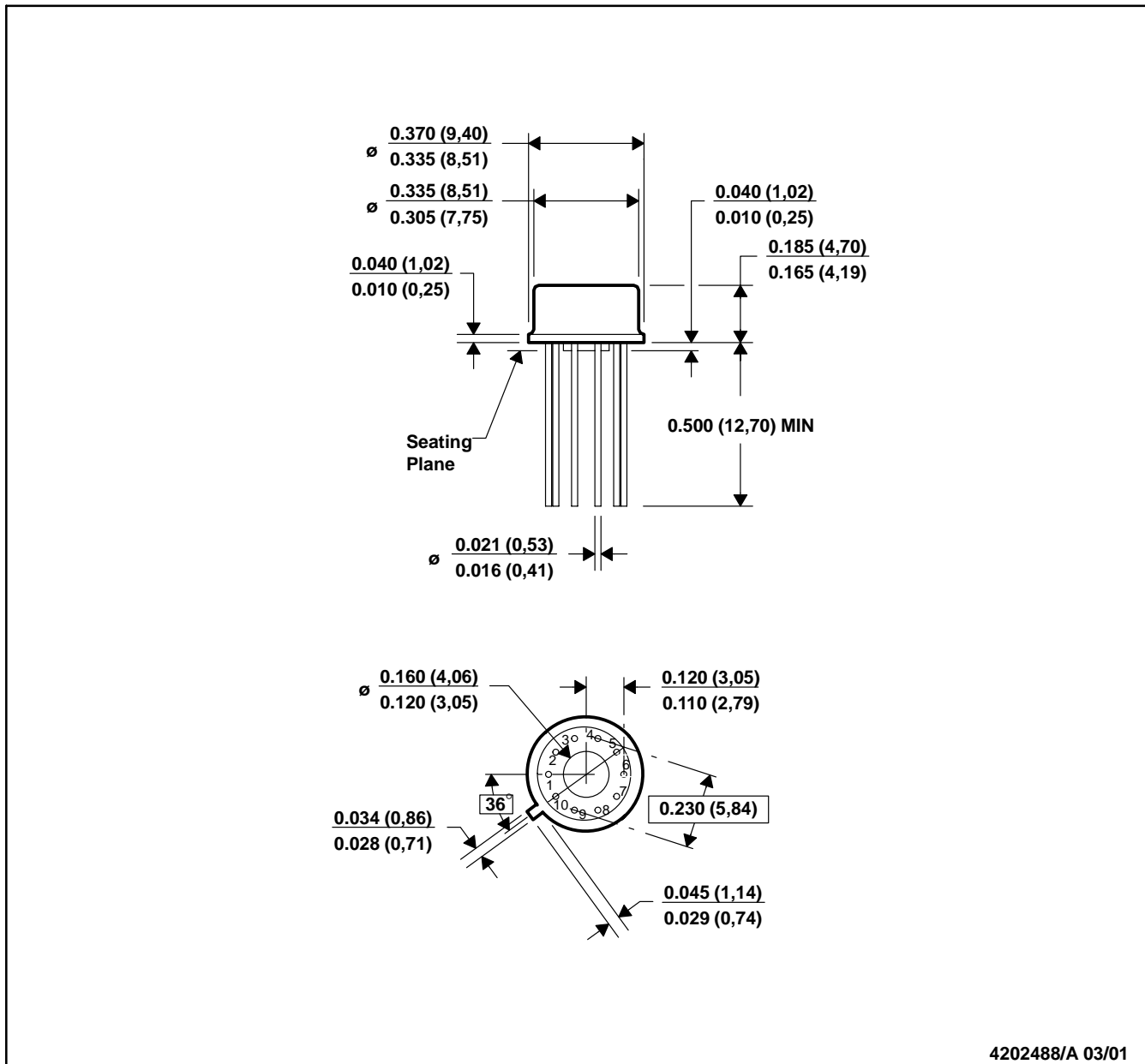

- NOTES: A. All linear dimensions are in inches (millimeters).  
 B. This drawing is subject to change without notice.  
 C. Leads in true position within 0.010 (0,25) R @ MMC at seating plane.  
 D. Pin numbers shown for reference only. Numbers may not be marked on package.  
 E. Falls within JEDEC MO-006/TO-100.

NFF0014A

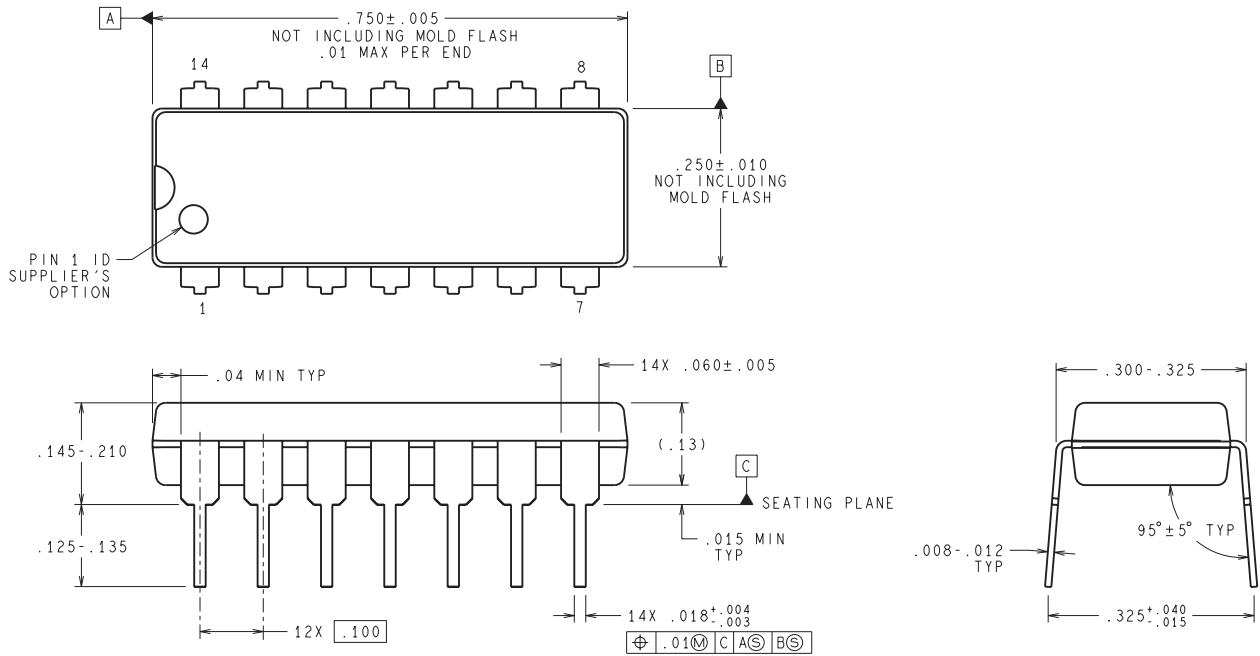

**DIMENSIONS ARE IN INCHES**  
 DIMENSIONS IN ( ) FOR REFERENCE ONLY

N14A (Rev G)



## IMPORTANT NOTICE

Texas Instruments Incorporated and its subsidiaries (TI) reserve the right to make corrections, enhancements, improvements and other changes to its semiconductor products and services per JESD46, latest issue, and to discontinue any product or service per JESD48, latest issue. Buyers should obtain the latest relevant information before placing orders and should verify that such information is current and complete. All semiconductor products (also referred to herein as "components") are sold subject to TI's terms and conditions of sale supplied at the time of order acknowledgment.

TI warrants performance of its components to the specifications applicable at the time of sale, in accordance with the warranty in TI's terms and conditions of sale of semiconductor products. Testing and other quality control techniques are used to the extent TI deems necessary to support this warranty. Except where mandated by applicable law, testing of all parameters of each component is not necessarily performed.

TI assumes no liability for applications assistance or the design of Buyers' products. Buyers are responsible for their products and applications using TI components. To minimize the risks associated with Buyers' products and applications, Buyers should provide adequate design and operating safeguards.

TI does not warrant or represent that any license, either express or implied, is granted under any patent right, copyright, mask work right, or other intellectual property right relating to any combination, machine, or process in which TI components or services are used. Information published by TI regarding third-party products or services does not constitute a license to use such products or services or a warranty or endorsement thereof. Use of such information may require a license from a third party under the patents or other intellectual property of the third party, or a license from TI under the patents or other intellectual property of TI.

Reproduction of significant portions of TI information in TI data books or data sheets is permissible only if reproduction is without alteration and is accompanied by all associated warranties, conditions, limitations, and notices. TI is not responsible or liable for such altered documentation. Information of third parties may be subject to additional restrictions.

Resale of TI components or services with statements different from or beyond the parameters stated by TI for that component or service voids all express and any implied warranties for the associated TI component or service and is an unfair and deceptive business practice. TI is not responsible or liable for any such statements.

Buyer acknowledges and agrees that it is solely responsible for compliance with all legal, regulatory and safety-related requirements concerning its products, and any use of TI components in its applications, notwithstanding any applications-related information or support that may be provided by TI. Buyer represents and agrees that it has all the necessary expertise to create and implement safeguards which anticipate dangerous consequences of failures, monitor failures and their consequences, lessen the likelihood of failures that might cause harm and take appropriate remedial actions. Buyer will fully indemnify TI and its representatives against any damages arising out of the use of any TI components in safety-critical applications.

In some cases, TI components may be promoted specifically to facilitate safety-related applications. With such components, TI's goal is to help enable customers to design and create their own end-product solutions that meet applicable functional safety standards and requirements. Nonetheless, such components are subject to these terms.

No TI components are authorized for use in FDA Class III (or similar life-critical medical equipment) unless authorized officers of the parties have executed a special agreement specifically governing such use.

Only those TI components which TI has specifically designated as military grade or "enhanced plastic" are designed and intended for use in military/aerospace applications or environments. Buyer acknowledges and agrees that any military or aerospace use of TI components which have **not** been so designated is solely at the Buyer's risk, and that Buyer is solely responsible for compliance with all legal and regulatory requirements in connection with such use.

TI has specifically designated certain components as meeting ISO/TS16949 requirements, mainly for automotive use. In any case of use of non-designated products, TI will not be responsible for any failure to meet ISO/TS16949.

### Products

Audio	<a href="http://www.ti.com/audio">www.ti.com/audio</a>
Amplifiers	<a href="http://amplifier.ti.com">amplifier.ti.com</a>
Data Converters	<a href="http://dataconverter.ti.com">dataconverter.ti.com</a>
DLP® Products	<a href="http://www.dlp.com">www.dlp.com</a>
DSP	<a href="http://dsp.ti.com">dsp.ti.com</a>
Clocks and Timers	<a href="http://www.ti.com/clocks">www.ti.com/clocks</a>
Interface	<a href="http://interface.ti.com">interface.ti.com</a>
Logic	<a href="http://logic.ti.com">logic.ti.com</a>
Power Mgmt	<a href="http://power.ti.com">power.ti.com</a>
Microcontrollers	<a href="http://microcontroller.ti.com">microcontroller.ti.com</a>
RFID	<a href="http://www.ti-rfid.com">www.ti-rfid.com</a>
OMAP Applications Processors	<a href="http://www.ti.com/omap">www.ti.com/omap</a>
Wireless Connectivity	<a href="http://www.ti.com/wirelessconnectivity">www.ti.com/wirelessconnectivity</a>

### Applications

Automotive and Transportation	<a href="http://www.ti.com/automotive">www.ti.com/automotive</a>
Communications and Telecom	<a href="http://www.ti.com/communications">www.ti.com/communications</a>
Computers and Peripherals	<a href="http://www.ti.com/computers">www.ti.com/computers</a>
Consumer Electronics	<a href="http://www.ti.com/consumer-apps">www.ti.com/consumer-apps</a>
Energy and Lighting	<a href="http://www.ti.com/energy">www.ti.com/energy</a>
Industrial	<a href="http://www.ti.com/industrial">www.ti.com/industrial</a>
Medical	<a href="http://www.ti.com/medical">www.ti.com/medical</a>
Security	<a href="http://www.ti.com/security">www.ti.com/security</a>
Space, Avionics and Defense	<a href="http://www.ti.com/space-avionics-defense">www.ti.com/space-avionics-defense</a>
Video and Imaging	<a href="http://www.ti.com/video">www.ti.com/video</a>

### TI E2E Community

[e2e.ti.com](http://e2e.ti.com)