

# APPROVAL SHEET

## **BROADBAND RFCMF 1632(0612) Series – RoHS Compliance**

MULTILAYER COMMON MODE FILTER

For USB 2.0 / IEEE 1394 Application

**RFCMF1632100M3T series**

## FEATURES

1. Multilayer LTCC ( Low Temperature Cofired Ceramics ) Technology
2. Reflow solderable SMD Devices
3. Miniatured Size 1.6 x 3.2 x 1.0 mm<sup>3</sup>
4. Low Differential Mode Insertion Loss maximum 0.6 dB @ 240MHz
5. High Common Mode attenuation minimum 9.0dB @ 240MHz ~ 1.0GHz
6. Special 3D layout design to minimize phase shifting

## APPLICATIONS

1. USB 2.0/ IEEE 1394 high speed data transmission
2. PC related, DSC, Scanner, Data Storage Devices, CD ROM R/W, Printer

## CONSTRUCTION and Schematic

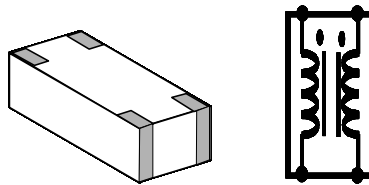

Fig 1. Outline of 1632 size Common Mode Filter and Schematics

## DESCRIPTION

Walsin Technology Corporation develops a new ceramic Common Mode Filter specified for the EMI suppression on USB 2.0/ IEEE 1394 high speed data transmission, as shown in fig-1. The new specification, USB 2.0 released in April 2000, describes a high-speed of 480 Mbps. The major goal is to replace most of the traditional ports on a PC with one versatile and user-friendly interface. IEEE-1394 has a bus speed of 400 Mbps, and IEEE-1394b proposes to increase this rate to 3.2 Gbps. Under such a high speed, to suppress the serious EMI is a key issue for developer. The Common Mode Filter offered by Walsin Technology Corporation has been designed to a high suppression on Common Mode Noise as well as low insertion loss characteristics on Differential Mode Signal through Walsin's advanced LTCC (Low Temperature Co-fired Ceramic) technology and superior product design via 3D EM Simulation Skill.

This Common Mode Filter has a rectangular ceramic body with a tiny dimension of 1.6 x 3.2 x 1.0 mm<sup>3</sup> future meet the SMT automation and miniaturization requirements on modern devices.

## DIMENSIONS

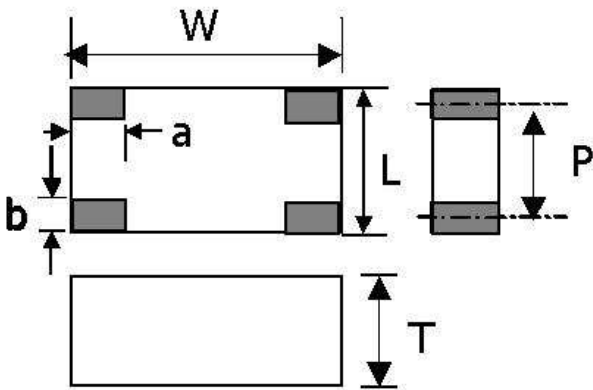
Figure	Symbol	Dimension
	L	1.60 ± 0.20 mm
	W	3.20 ± 0.20 mm
	T	1.00 ± 0.20 mm
	P	1.10 ± 0.20 mm
	a	0.60 ± 0.20 mm
	b	0.50 ± 0.20 mm

**LAND PATTERN**

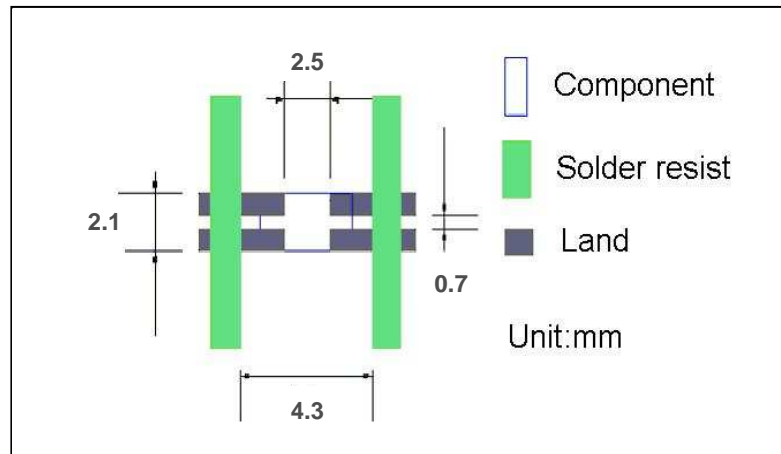

Remark : Improper land pattern design may influence signal quality

**ELECTRICAL CHARACTERISTICS**

RFCMF1632100M3T	Specification
Common Mode Attenuation	Min. 9.0dB @ 240 MHz ~ 1.0 GHz
Differential Mode Insertion Loss	Max. 0.6 dB @ 240MHz
DC Resistance	Max. 1.5 $\Omega$
Rated Current	300 mA
Characteristic Impedance ( Differential )	90 $\Omega$
Operating Temperature	- 40 $^{\circ}\text{C}$ ~ +85 $^{\circ}\text{C}$

**TYPICAL ELECTRICAL CHARACTERISTICS**

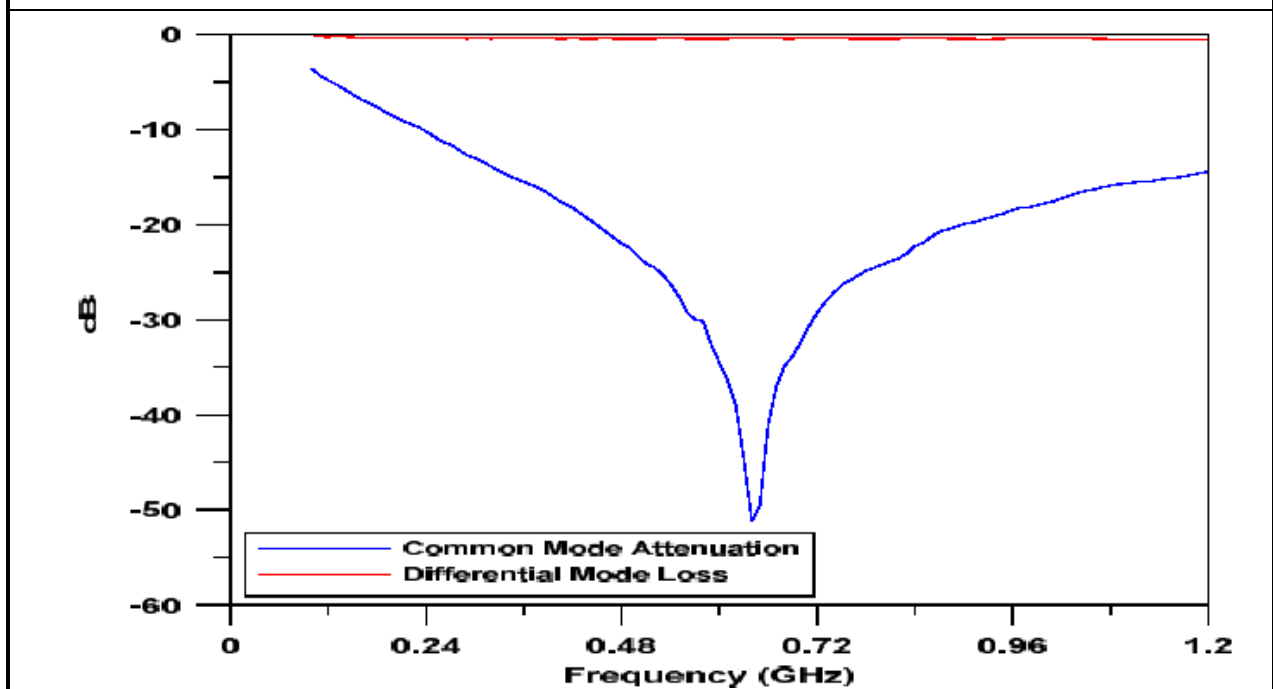

## RELIABILITY TEST

Test item	Test condition / Test method	Specification
Solderability JIS C 0050-4.6 JESD22-B102D	*Solder bath temperature : $235 \pm 5^{\circ}\text{C}$ *Immersion time : $2 \pm 0.5$ sec *Solder : Sn3Ag0.5Cu for lead-free	At least 95% of a surface of each terminal electrode must be covered by fresh solder.
Leaching (Resistance to dissolution of metallization) IEC 60068-2-58	*Solder bath temperature : $260 \pm 5^{\circ}\text{C}$ *Leaching immersion time : $30 \pm 0.5$ sec *Solder : SN63A	Loss of metallization on the edges of each electrode shall not exceed 25%.
Resistance to soldering heat JIS C 0050-5.4	*Preheating temperature : $120\sim 150^{\circ}\text{C}$ , 1 minute. *Solder temperature : $270\pm 5^{\circ}\text{C}$ *Immersion time : $10\pm 1$ sec *Solder : Sn3Ag0.5Cu for lead-free Measurement to be made after keeping at room temperature for $24\pm 2$ hrs	No mechanical damage. Samples shall satisfy electrical specification after test. Loss of metallization on the edges of each electrode shall not exceed 25%.
Drop Test JIS C 0044	*Height : 75 cm *Test Surface : Rigid surface of concrete or steel. *Times : 6 surfaces for each units ; 2 times for each side.	No mechanical damage. Samples shall satisfy electrical specification after test.
Adhesive Strength of Termination JIS C 0051- 7.4.3	*Pressurizing force : $5\text{N}(\leq 0603)$ ; $10\text{N}( >0603)$ *Test time : $10\pm 1$ sec	No remarkable damage or removal of the termination.
Bending test JIS C 0051- 7.4.1	The middle part of substrate shall be pressurized by means of the pressurizing rod at a rate of about 1 mm/s per second until the deflection becomes 1mm/s and then pressure shall be maintained for $5\pm 1$ sec. Measurement to be made after keeping at room temperature for $24\pm 2$ hours	No mechanical damage. Samples shall satisfy electrical specification after test.

Temperature cycle JIS C 0025	<ol style="list-style-type: none"> <li>1. 30±3 minutes at -40°C±3°C,</li> <li>2. 10~15 minutes at room temperature,</li> <li>3. 30±3 minutes at +85°C±3°C,</li> <li>4. 10~15 minutes at room temperature,</li> </ol> Total 100 continuous cycles  Measurement to be made after keeping at room temperature for 24±2 hrs	No mechanical damage.  Samples shall satisfy electrical specification after test.
Vibration JIS C 0040	*Frequency : 10Hz~55Hz~10Hz(1min) *Total amplitude : 1.5mm *Test times : 6hrs.(Two hrs each in three mutually perpendicular directions)	No mechanical damage.  Samples shall satisfy electrical specification after test.
High temperature JIS C 0021	*Temperature : 85°C±2°C *Test duration : 1000+24/-0 hours  Measurement to be made after keeping at room temperature for 24±2 hrs	No mechanical damage.  Samples shall satisfy electrical specification after test.
Humidity (steady conditions) JIS C 0022	*Humidity : 90% to 95% R.H. *Temperature : 40±2°C *Time : 1000+24/-0 hrs.  Measurement to be made after keeping at room temperature for 24±2 hrs ※ 500hrs measuring the first data then 1000hrs data	No mechanical damage.  Samples shall satisfy electrical specification after test.
Low temperature JIS C 0020	*Temperature : -40°C±2°C *Test duration : 1000+24/-0 hours  Measurement to be made after keeping at room temperature for 24±2 hrs	No mechanical damage.  Samples shall satisfy electrical specification after test.

**SOLDERING CONDITION**

Typical examples of soldering processes that provide reliable joints without any damage are given in Fig 2,

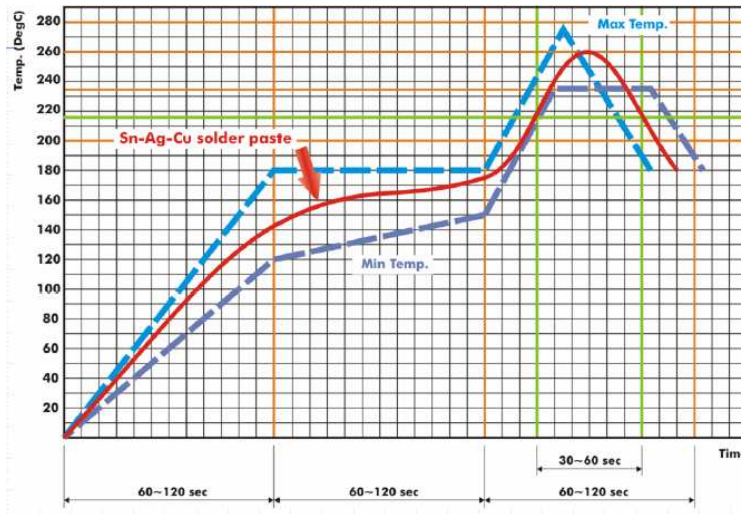
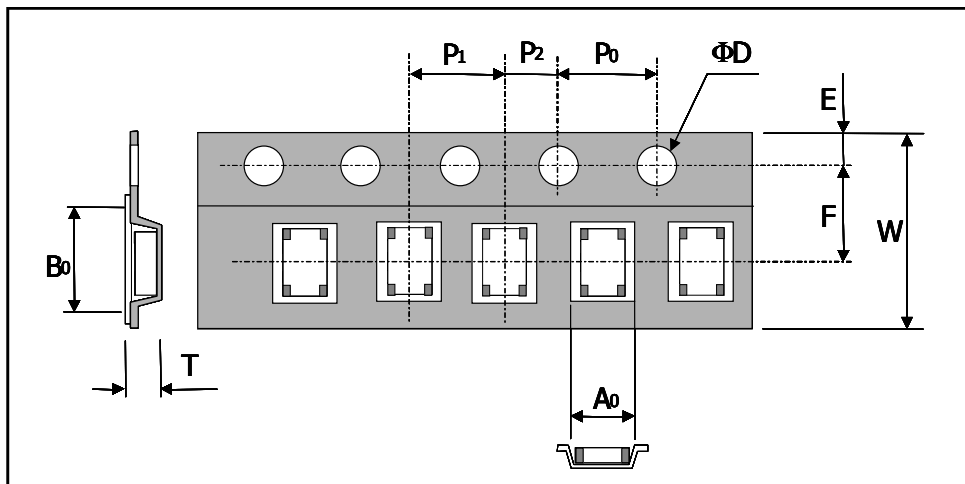

Fig 2. Infrared soldering profile

**ORDERING CODE**

<b>RF</b>	<b>CMF</b>	<b>163210</b>	<b>0</b>	<b>M</b>	<b>3</b>	<b>T</b>
Walsin RF device	Product Code CMF : Common Mode Filter	Dimension code 163209 = Length 16 , Width 32, Thickness 10	Unit of dimension 0 : 0.1 mm 1 : 1.0 mm	Application M: USB 2.0/ IEEE1394	Specification Design Code	Packing T : 7" Reeled

**PACKAGING**



**Plastic Tape specifications (unit :mm)**

Index	Ao	Bo	ΦD	T	W
Dimension (mm)	1.95 ± 0.10	3.45 ± 0.10	1.55 ± 0.10	1.3 ± 0.10	8.0 ± 0.30
Index	E	F	Po	P1	P2
Dimension (mm)	1.75 ± 0.10	3.50 ± 0.05	4.00 ± 0.10	4.00 ± 0.10	2.00 ± 0.10

## Reel dimensions

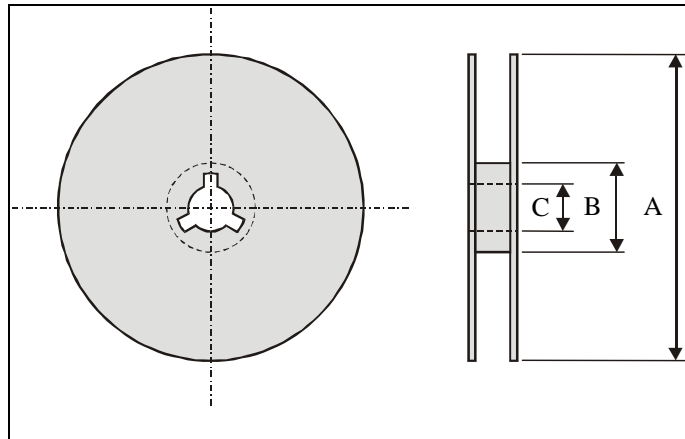

Index	A	B	C
Dimension (mm)	Φ178	Φ60.0	Φ13.5

Typing Quantity: 2000 pieces per 7" reel

### CAUTION OF HANDLING

#### Limitation of Applications

Please contact us before using our products for the applications listed below which require especially high reliability for the prevention of defects, which might directly cause damage to the third party's life, body or property.

- (1) Aircraft equipment
- (2) Aerospace equipment
- (3) Undersea equipment
- (4) Medical equipment
- (5) Disaster prevention / crime prevention equipment
- (6) Traffic signal equipment
- (7) Transportation equipment (vehicles, trains, ships, etc.)
- (8) Applications of similar complexity and /or reliability requirements to the applications listed in the above.

#### Storage condition

- (1) Products should be used in 6 months from the day of WALSIN outgoing inspection, which can be confirmed.
- (2) Storage environment condition.
  - Products should be storage in the warehouse on the following conditions.
  - Temperature : -10 to +40°C
  - Humidity : 30 to 70% relative humidity
  - Don't keep products in corrosive gases such as sulfur. Chlorine gas or acid or it may cause oxidization of electrode, resulting in poor solderability.
  - Products should be storage on the palette for the prevention of the influence from humidity, dust and son on.
  - Products should be storage in the warehouse without heat shock, vibration, direct sunlight and so on.
  - Products should be storage under the airtight packaged condition.