

# APPROVAL SHEET

**RGBLN 2012 (0805) Series – RoHS Compliance**

**MULTILAYER CERAMIC BALUN TRANSFORMER**

**Halogens Free Product**

**2.4 GHz ISM Band Working Frequency**

**P/N:RGBLN2012080A4T**

\*Contents in this sheet are subject to change without prior notice.

## FEATURES

1. Multilayer LTCC ( Low Temperature Cofired Ceramics ) Technology
2. Miniatured Size 2.00 x 1.25 x 0.8 mm<sup>3</sup>
3. Low Insertion Loss reduces power consumption
4. Low inband Amplitude and Phase imbalance enable high performance wireless system operation.
5. Enable for DC Biasing of PA or Mixer
6. Suitable for 2.45 GHz Working Frequency Operation
7. Special Balance/ Unbalance impedance is upon requested.

## APPLICATIONS

1. 2.4GHz ISM Band RF Application
2. Bluetooth, Wireless LAN, HomeRF

## CONSTRUCTION

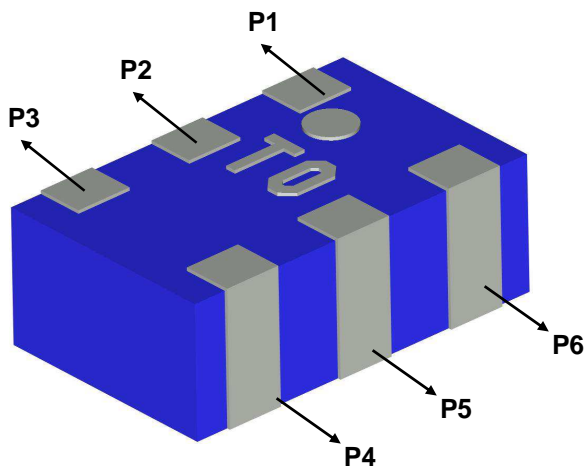

Fig 1. Outline of 2.4GHz Balun

PIN	Definition	PIN	Definition
P1	Unbalance Port	P4	Balance Port
P2	GND or DC feed	P5	GND
P3	Balance Port	P6	NC

## DESCRIPTION

Walsin Technology Corporation develops a new ceramic Balun Transformer specified for 2.45 GHz ISM Band application, as shown in fig-1. Both of Wireless LAN IEEE 802.11b, and Bluetooth™ typically located on this unlicensed frequency band which range covers from 2.4GHz to 2.5GHz. To fulfil the in-band and out-band frequency requirements, this ceramic Balun has been designed to a low Amplitude imbalance and Phase imbalance, wide bandwidth (-10dB) as well as low insertion loss characteristics through Walsin's advanced LTCC (Low Temperature Co-fired Ceramic) technology and superior product design via 3D EM Simulation Skill.

This ceramic Balun has a rectangular ceramic body with a tiny dimension of 2.00 x 1.25 x 0.8 mm<sup>3</sup> future meet the SMT automation and miniaturization requirements on modern portable devices.

## DIMENSIONS

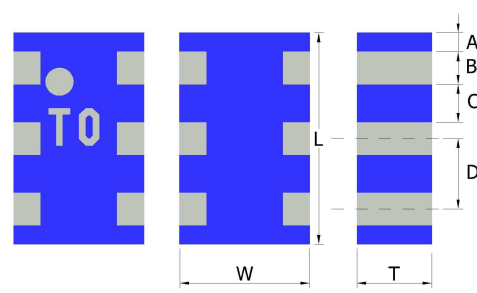
Figure	Symbol	Dimension
	L	2.00 ± 0.15 mm
	W	1.25 ± 0.15 mm
	T	0.80 ± 0.10 mm
	A	0.20 ± 0.20 mm
	B	0.30 ± 0.20 mm
	C	0.35 ± 0.20 mm
	D	0.65 ± 0.20 mm

**ELECTRICAL CHARACTERISTICS**

<b>RGBLN2012080A4T</b>	<b>Specification</b>
Frequency range	2450 ± 50 MHz
Insertion Loss (dB)	1.5
Impedance ( Ω ) Unbalanced	50
Impedance ( Ω ) Balanced	50
Return Loss (dB) Min.	10
Amplitude Balance (dB)	2.0
Phase Balance (degree)	180° ± 10°
Operation Temperature Range	-40°C ~ +85°C

**Typical Electrical Chart**

**(1). Amplitude balance**

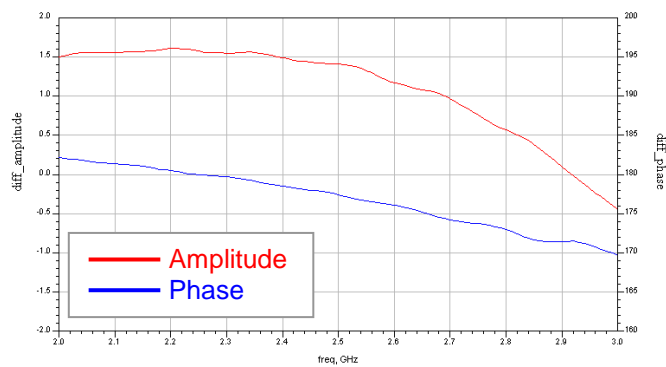

**(2). Insertion Loss and Return Loss**

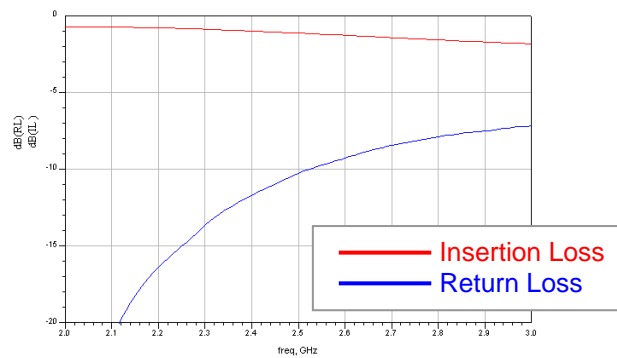

**SOLDER LAND PATTERN**

Figure	Symbol	Dimension (mm)
	A	1.00 ± 0.10
	B	0.35 ± 0.10
	C	0.30 ± 0.10
	D	0.65 ± 0.10
	E	0.80 ± 0.10
<p>Line width to be design to match 50Ω characteristic impedance, depending on PCB material and thickness</p>		

## RELIABILITY TEST

Test item	Test condition / Test method	Specification
Solderability JIS C 0050-4.6 JESD22-B102D	*Solder bath temperature : $235 \pm 5^{\circ}\text{C}$ *Immersion time : $2 \pm 0.5$ sec *Solder : Sn3Ag0.5Cu for lead-free	At least 95% of a surface of each terminal electrode must be covered by fresh solder.
Leaching (Resistance to dissolution of metallization) IEC 60068-2-58	*Solder bath temperature : $260 \pm 5^{\circ}\text{C}$ *Leaching immersion time : $30 \pm 0.5$ sec *Solder : SN63A	Loss of metallization on the edges of each electrode shall not exceed 25%.
Resistance to soldering heat JIS C 0050-5.4	*Preheating temperature : $120\sim 150^{\circ}\text{C}$ , 1 minute. *Solder temperature : $270\pm 5^{\circ}\text{C}$ *Immersion time : $10\pm 1$ sec *Solder : Sn3Ag0.5Cu for lead-free Measurement to be made after keeping at room temperature for $24\pm 2$ hrs	No mechanical damage. Samples shall satisfy electrical specification after test. Loss of metallization on the edges of each electrode shall not exceed 25%.
Drop Test JIS C 0044	*Height : 75 cm *Test Surface : Rigid surface of concrete or steel. *Times : 6 surfaces for each units ; 2 times for each side.	No mechanical damage. Samples shall satisfy electrical specification after test.
Adhesive Strength of Termination JIS C 0051- 7.4.3	*Pressurizing force : 5N( $\leq 0603$ ) ; 10N(>0603) *Test time : $10\pm 1$ sec	No remarkable damage or removal of the termination.
Bending test JIS C 0051- 7.4.1	The middle part of substrate shall be pressurized by means of the pressurizing rod at a rate of about 1 mm/s per second until the deflection becomes 1mm/s and then pressure shall be maintained for $5\pm 1$ sec. Measurement to be made after keeping at room temperature for $24\pm 2$ hours	No mechanical damage. Samples shall satisfy electrical specification after test.

Temperature cycle JIS C 0025	<ol style="list-style-type: none"> <li>1. 30±3 minutes at -40°C±3°C,</li> <li>2. 10~15 minutes at room temperature,</li> <li>3. 30±3 minutes at +85°C±3°C,</li> <li>4. 10~15 minutes at room temperature,</li> </ol> Total 100 continuous cycles Measurement to be made after keeping at room temperature for 24±2 hrs	No mechanical damage. Samples shall satisfy electrical specification after test.
Vibration JIS C 0040	*Frequency : 10Hz~55Hz~10Hz(1min) *Total amplitude : 1.5mm *Test times : 6hrs.(Two hrs each in three mutually perpendicular directions)	No mechanical damage. Samples shall satisfy electrical specification after test.
High temperature JIS C 0021	*Temperature : 85°C±2°C *Test duration : 1000+24/-0 hours Measurement to be made after keeping at room temperature for 24±2 hrs	No mechanical damage. Samples shall satisfy electrical specification after test.
Humidity (steady conditions) JIS C 0022	*Humidity : 90% to 95% R.H. *Temperature : 40±2°C *Time : 1000+24/-0 hrs. Measurement to be made after keeping at room temperature for 24±2 hrs ※ 500hrs measuring the first data then 1000hrs data	No mechanical damage. Samples shall satisfy electrical specification after test.
Low temperature JIS C 0020	*Temperature : -40°C±2°C *Test duration : 1000+24/-0 hours Measurement to be made after keeping at room temperature for 24±2 hrs	No mechanical damage. Samples shall satisfy electrical specification after test.

**SOLDERING CONDITION**

Typical examples of soldering processes that provide reliable joints without any damage are given in Fig 2,

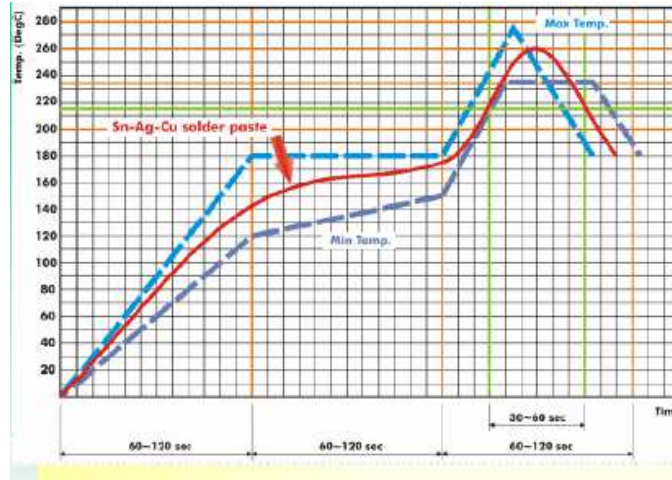

Fig 2. Infrared soldering profile

**ORDERING CODE**

<b>RG</b> Walsin RG: RF /Pb free device	<b>BLN</b> Product Code BLN : BALUN	<b>201208</b> Dimension code Per 2 digits of Length, Width, Thickness : e.g. : 201208 = Length 20, Width 12, Thickness 08	<b>0</b> Unit of dimension 0 : 0.1 mm 1 : 1.0 mm	<b>A</b> Application A : 2.4GHZ ISM Band	<b>4</b> Specification Design Code	<b>T</b> Packing T : 7" Reeled
---	--	--	--	---	--	--------------------------------------

Minimum Ordering Quantity: 2000 pcs per reel.

**PACKAGING**

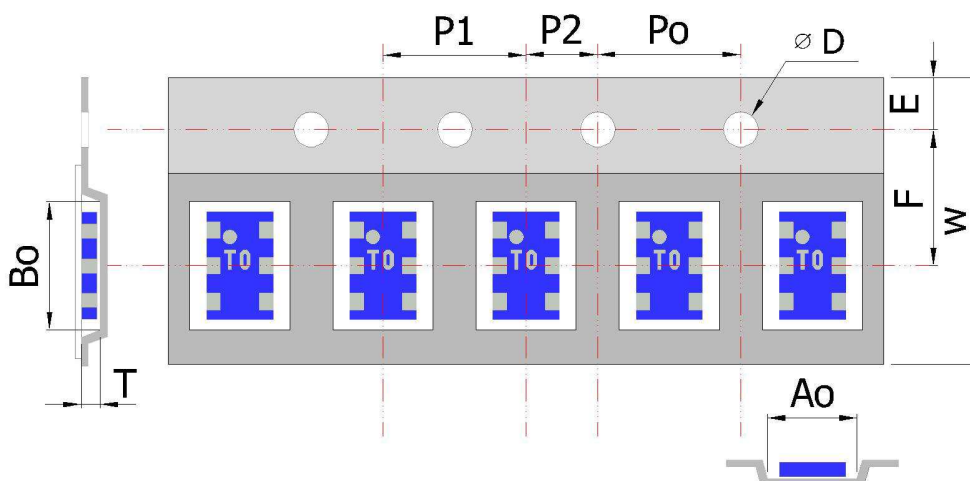

**Plastic Tape specifications (unit :mm)**

Index	Ao	Bo	ΦD	T	W
Dimension (mm)	1.35 ± 0.10	2.30 ± 0.10	1.55 ± 0.10	0.95 ± 0.10	8.0 ± 0.30
Index	E	F	Po	P1	P2
Dimension (mm)	1.75 ± 0.10	3.50 ± 0.05	4.00 ± 0.10	4.00 ± 0.10	2.00 ± 0.10

## Reel dimensions

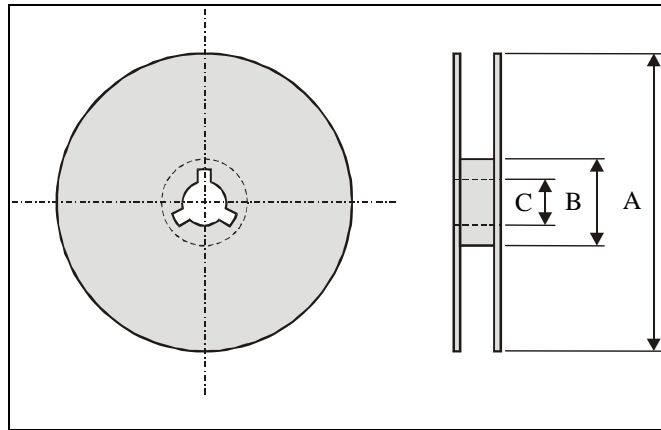

Index	A	B	C
Dimension (mm)	Φ178	Φ60.0	Φ13.5

Typing Quantity: 2000 pieces per 7" reel

## CAUTION OF HANDLING

### Limitation of Applications

Please contact us before using our products for the applications listed below which require especially high reliability for the prevention of defects, which might directly cause damage to the third party's life, body or property.

- (1) Aircraft equipment
- (2) Aerospace equipment
- (3) Undersea equipment
- (4) Medical equipment
- (5) Disaster prevention / crime prevention equipment
- (6) Traffic signal equipment
- (7) Transportation equipment (vehicles, trains, ships, etc.)
- (8) Applications of similar complexity and /or reliability requirements to the applications listed in the above.

### Storage condition

- (1) Products should be used in 6 months from the day of WALSIN outgoing inspection, which can be confirmed.
- (2) Storage environment condition.
  - Products should be storage in the warehouse on the following conditions.
  - Temperature : -10 to +40°C
  - Humidity : 30 to 70% relative humidity
  - Don't keep products in corrosive gases such as sulfur. Chlorine gas or acid or it may cause oxidization of electrode, resulting in poor solderability.
  - Products should be storage on the palette for the prevention of the influence from humidity, dust and so on.
  - Products should be storage in the warehouse without heat shock, vibration, direct sunlight and so on.
  - Products should be storage under the airtight packaged condition.