

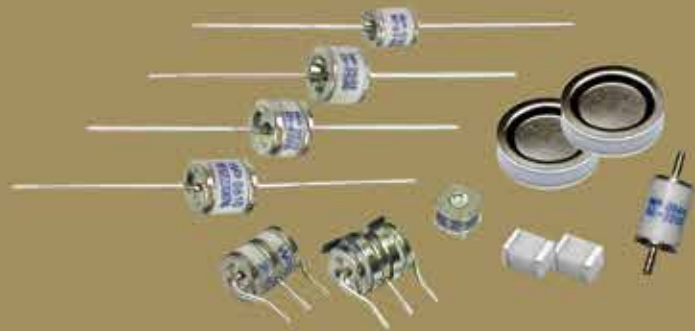

WORLD PRODUCTS INC.

GAS DISCHARGE TUBES



WORLD PRODUCTS INC. || 19654 Eighth Street East || P.O. Box 517 || Sonoma, CA 95476
Phone: (707) 996.5201 || FAX: (707) 996.3380 || www.worldproducts.com || sales@worldproducts.com
©2013 World Products Inc.



2 & 3 Electrode Surface Mount Series

Part Numbering System

Example part number:

WPGT - 3SSM 230 D TR
 (1) (2) (3) (4) (5)

(1) **World Products Gas Discharge Tubes**

(2) **Series Code**

- 2SM = 2 Electrode Surface Mount Mini Series
- 2S = 2 Electrode Surface Mount Standard Series
- 2SS = 2 Electrode Surface Mount Mini Square Series
- 2SR = 2 Electrode Surface Mount Standard Low Profile Series
- 2SN = 2 Electrode Surface Mount Super Mini Series
- 2SF = 2 Electrode Surface Mount Ultra Super Mini Series
- 3216* = 2 Electrode Surface Mount Chip Series
- 4532* = 2 Electrode Surface Mount Chip Series
- 3SM = 3 Electrode Surface Mount Mini Series
- 3SSM = 3 Electrode Surface Mount Symmetrical Series

(3) **DC Breakdown Voltage**

(Please reference specification to determine available voltage options for each series.)

- 70 = 70V
- 75 = 75V
- 90 = 90V
- 120 = 120V
- 145 = 145V
- 150 = 150V
- 200 = 200V
- 230 = 230V
- 250 = 250V
- 300 = 300V
- 350 = 350V
- 400 = 400V
- 420 = 420V
- 470 = 470V
- 500 = 500V
- 600 = 600V
- 800 = 800V
- 1100 = 1100V
- 1200 = 1200V
- 1800 = 1800V
- 2000 = 2000V
- 2500 = 2500V
- 2700 = 2700V
- 3000 = 3000V

(4) **D** = Special DC Voltage Breakdown - 3SSM Series Only

(5) **Taping Specifications**

TR = Tape & Reel

* 3216 and 4532 only available on tape and reel "TR" suffix.

2 Electrode Surface Mount Chip Series (4532)

Specifications

Base Part Number	DC Breakdown Voltage (V)			Maximum Impulse Discharge Current (8/20us) (KA)	Alternating Discharge Current (A)		Impulse withstanding voltage capacity (KV)		Impulse Life (8/20us) 100A	Minimum Insulation Resistance (1GΩ)	Maximum Capacitance (pf)
	100V/s	100V/μs	1000V/μs		50Hz, 1 sec	10 times	10/700us R=25Ω	10 times (5 times each polarity)			
WP-4532-75	55 - 95	500	650	2	2	6	300	1	0.5 max.		
WP-4532-90	63 - 117	500	650								
WP-4532-120	84 - 156	500	650								
WP-4532-150	105 - 195	500	650								
WP-4532-200	140 - 260	600	700								
WP-4532-230	161 - 299	650	750								
WP-4532-300	210 - 390	700	800			4					
WP-4532-350	245 - 455	750	850								
WP-4532-400	280 - 520	800	900								
WP-4532-420	294 - 546	850	950								
WP-4532-470	329 - 611	900	1000								
WP-4532-500	350 - 650	900	1000								
WP-4532-600	420 - 780	1000	1100								

UL497B Recognized, File #E135015

*DC Breakdown Voltage	DC Measuring Voltage
75 - 150V	50V
200 - 400V	100V
420-600V	250V

Dimensions

Unit: mm

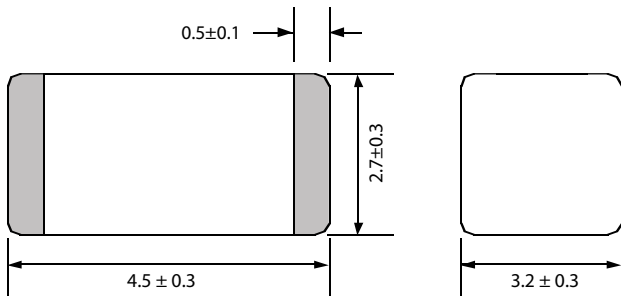

Recommended Pad Size

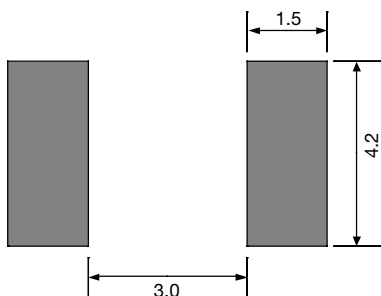

Packaging

Standard Bulk Packaging

Axial or Radial Lead 100 pieces per plastic tray 500 pieces per inner box 10 inner boxes per carton 5000 pieces per full carton	Axial or Radial Lead (2RF and 2RN) 200 pieces per plastic tray 1600 pieces per inner box 10 inner boxes per carton 16000 pieces per full carton	Surface Mount 100 pieces per plastic tray 500 pieces per inner box 10 inner boxes per carton 5000 pieces per full carton	20B ONLY 40 pieces per plastic tray 200 pieces per inner box 10 inner boxes per carton 2000 pieces per full carton
--	--	---	---

2RM, 2R, 2N, 2T, 2RC Axial Lead Taping

Unit: mm
Complies to EIA-296-E and EN60286-1.

Item	Dimensions
L1	52.2 ± 2.0
L	64.0 ± 3.0
D	10 ± 0.5
F	Length + 1.4 Max.

2RM, 2R, 2N, 2T Axial Lead Ammo Box

Unit: mm
Quantity: 500 pieces

Item	Dimensions
A	255 Max.
B	75 ± 5.0
C	68 ± 5.0

2RM, 2R, 2RS, 2RN, 2RF, 2N, 2T, 2RC Axial Lead Reel

Unit: mm
Quantity: 500 pieces

2S, 2SM, 2SS, 2SN, 2SF, 3SM, 3SSM, 3216 & 4532 SMD Reel

Unit: mm
Quantity: See SMD Taping

* for 3216 this dimension is 60 typ.
** for 3216 this dimension is 15 typ.

20B and AE Standard Bulk Packaging

Series	Plastic Tray	Inner Box	Full Carton
20B=	40 Pieces per Plastic Tray	200 Pieces per Inner Box	2000 Pieces per Full Carton
AE= (Standard & High Current Series)	60 Pieces per Plastic Tray	180 Pieces per Inner Box	1800 Pieces per Full Carton
(Ultra High Current & Screw Lead Series)	35 Pieces per Plastic Tray	105 Pieces per Inner Box	1050 Pieces per Full Carton

NOTE: For Series Types:

12D8	18D7
12D12	20D6
12D17	25D10W
12D18	25D21
16D5	30D12

Please consult World Products Inc.

Packaging (continued)

2S and 2SR SMD Taping

Unit: mm

Quantity: 800 pieces per reel (13") - [Beginning March 2007]
 3 reels per inner box
 5 inner boxes per carton
 12,000 pieces per full carton - [Beginning March 2007]

Item	Dimensions
P	12.0 ± 0.1
P ₀	4.0 ± 0.1
W	16.0 ± 0.3
F	7.5 ± 0.1

Item	Dimensions
E	1.75 ± 0.1
D	1.55 ± 0.1
K*	6.4 ± 0.1
t*	0.4 ± 0.05

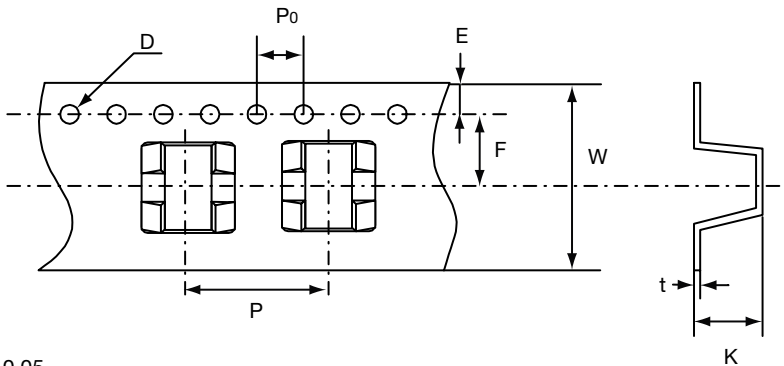

*For 2SR: "K" dimension is 5.4 ± 0.1 and "t" dimension is 0.5 ± 0.05

2SM and 2SS SMD Taping

Unit: mm

Quantity: 900 pieces per reel (13")
 3 reels per inner box
 5 inner boxes per carton
 13,500 pieces per full carton

Item	Dimensions
P	12.0 ± 0.1
P ₀	4.0 ± 0.1
W	16.0 ± 0.3
F	7.5 ± 0.1
B ₀	4.3 ± 0.1

Item	Dimensions
E	1.75 ± 0.1
D	1.5 ± 0.1
t	0.5 typ
A ₀	4.5 ± 0.1
K ₀	4.6 ± 0.1
K ₁	0 ± 0.1
D ₁	0 ± 0.1
P ₂	2 ± 0.1

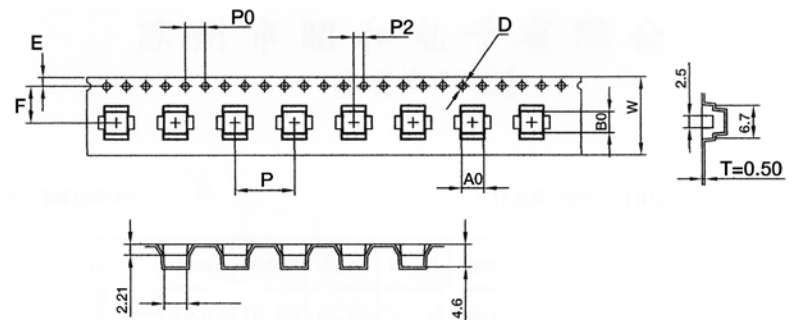

2SN and 2SF Taping

Unit: mm

Quantity: 2000 pieces per reel (13")
 3 reels per inner box
 5 inner boxes per carton
 30,000 pieces per full carton

Item	Dimensions
P	8.0 ± 0.1
P ₀	4.0 ± 0.1
A	3.9 ± 0.3
B*	4.3 ± 0.1

Item	Dimensions
D	1.55 ± 0.05
W	16.0 ± 0.3
K ₀	3.9 ± 0.1
t	0.4 ± 0.05

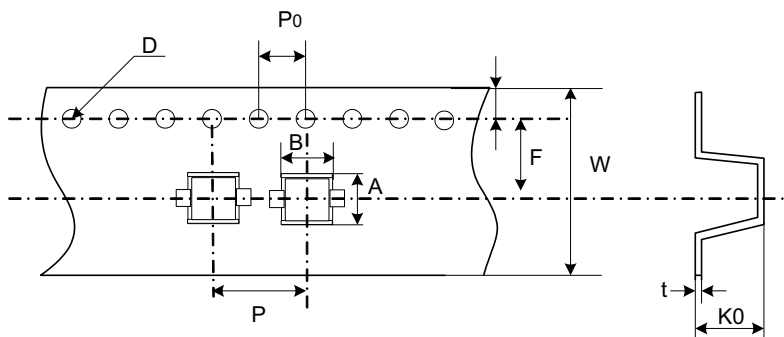

*For 2SF this dimension is 3.2mm ± 0.1mm.

Packaging (continued)

3SM & 3SSM SMD Taping

Unit: mm

Quantity: 900 pieces per reel (13")
 3 reels per inner box
 5 inner boxes per carton
 13,500 pieces per full carton

Item	Dimensions
P	12.0 ± 0.1
P ₀	4.0 ± 0.1
W	16.0 ± 0.3
F	7.5 ± 0.1
B	5.4 ± 0.1

Item	Dimensions
E	1.75 ± 0.1
D	1.55 ± 0.05
K	5.5 ± 0.1
t	0.5 ± 0.05
A	7.28 ± 0.1

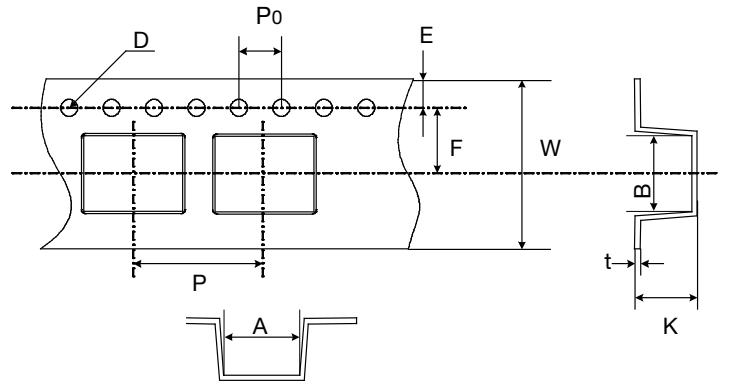

3216 and 4532 Taping

Unit: mm

Quantity: 3,000 pieces per reel (13") - 3216 size
 2,500 pieces per reel (13") - 4532 size
 3 reels per inner box - 3216 and 4532 size
 5 inner boxes per carton - 3216 and 4532 size
 45,000 pieces per full carton - 3216 size
 37,500 pieces per full carton - 4532 size

Item	Dimensions
P	8.0 ± 0.1
P ₀	4.0 ± 0.1
W	12.0 ± 0.3
F	5.45 ± 0.1
E	1.75 ± 0.1

Item	Dimensions
D	1.55 ± 0.05
K*	3.0 ± 0.1
t	0.3 ± 0.05

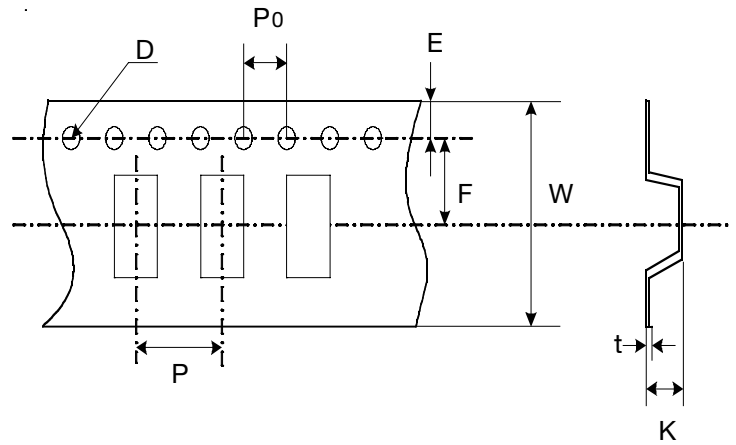

* for 3216 this dimension is 1.8 ± 0.1

GAS DISCHARGE TUBES

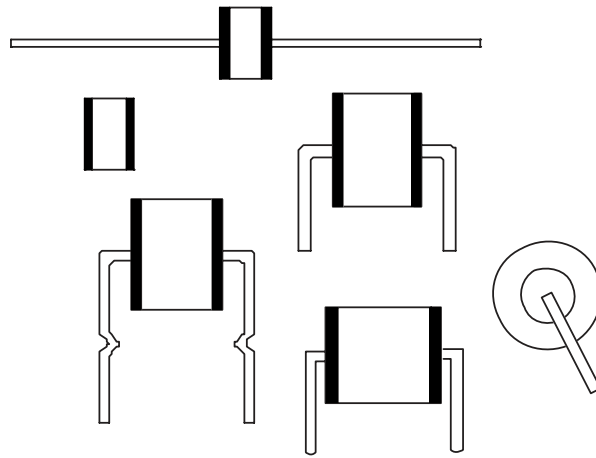

Gas Discharge Tube are designed to limit voltage surges on balanced or unbalanced communications circuits and on DC to 420 Hz power circuits. Although telephone circuits are a major application for gas tube surge arrestors, this guide will also provide useful information for other surge applications such as AC circuits.

Gas Tube in Antenna Protection

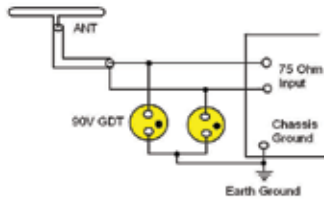

GDT in Cable Protection

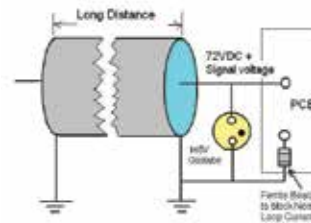

Motor (two wire System) Protection from Lightning

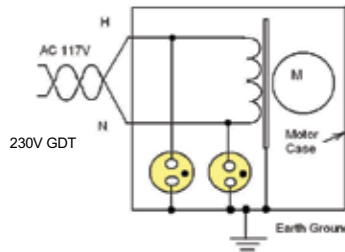

Gas Tube Application In AC Line Isolation

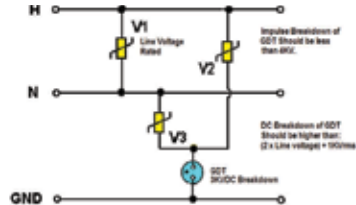

GDT & TVSD Telephone Line Protection

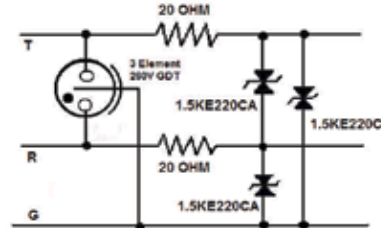

All application notes/circuits are shown as examples only. It is the responsibility of the purchaser to insure that the application meets purchaser's specifications. No representation or warranty, whether express or implied, is given and no liability is assumed by WPI with respect to the use of such examples.

WPI Reserves Copyright

DISCLAIMER: The names of the products and the specifications in this catalog are subject to change without notice for the sake of improvement. World Products Inc. also reserves the right to discontinue any of these products. The products in this catalog are intended for use in ordinary electronic products. If any of these products are to be used in special applications requiring extremely high reliability, where product defects might pose a safety risk, please consult World Products Inc. Though World Products Inc. has taken all possible precautions to ensure the quality and reliability of its products, improper use of products may result in bodily injury, fire, or similar accident. If you have any questions regarding the use of the products in question, please consult World Products Inc. Please be advised that World Products Inc. accepts no responsibility for any infraction by users of World Products Inc. products on third party patents or industrial copyrights.