

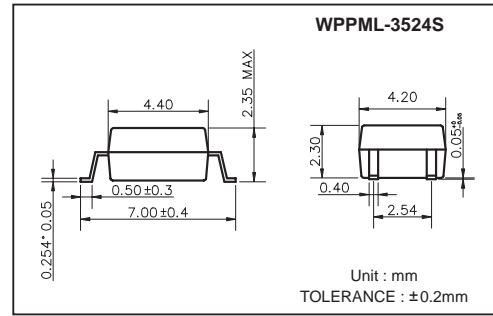

## Features

1. Normally open, single pole single throw.
2. Control 350VAC or DC voltage.
3. Switch 130mA loads.
4. LED control current, 5mA.
5. Low ON-resistance.
6. dv/dt, >500V/mS.
7. Isolation test voltage, 1500V<sub>RMS</sub>.



**Part Numbering System & Part Marking System:** Page 4.

## Absolute Maximum Ratings

(Ta=25°C)

Emitter ( Input )	Detector ( Output )
Reverse Voltage.....5.0V	Output Breakdown Voltage .....±350V
Continuous Forward Current .....50mA	Continuous Load Current .....±130mA
Peak Forward Current .....1A	Power Dissipation .....500mW
Power Dissipation .....100mW	
Derate Linearly from 25°C .....1.3mW/°C	
General Characteristics	
Isolation Test Voltage .....1500VRMS	Storage Temperature Range ...-40°C to +125°C
Isolation Resistance	Operating Temperature Range...-30°C to +85°C
V <sub>IO</sub> = 500V, T <sub>A</sub> = 25°C.....≥10 <sup>10</sup> Ω	Junction Temperature.....100°C
Total Power Dissipation .....550mW	Soldering Temperature,
Derate Linearly from 25°C .....2.5mW/°C	2mm from case, 10 sec .....260°C

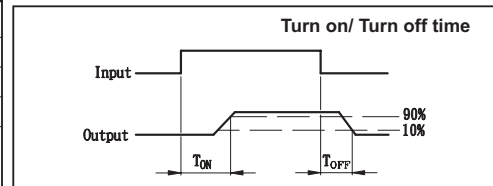

## Electro-optical Characteristics

(Ta=25°C)

Parameter	Symbol	Conditions	Min.	Typ.	Max.	Unit
Emitter (Input)						
Forward Voltage	V <sub>F</sub>	I <sub>F</sub> = 10mA		1.2	1.5	V
Operation Input Current	I <sub>FON</sub>	V <sub>L</sub> = ±20V, I <sub>L</sub> = 100mA, t = 10mS			5	mA
Recovery Input Current	I <sub>FOFF</sub>	V <sub>L</sub> = ±20V, I <sub>L</sub> ≤ 5μA	0.05			mA
Detector (Output)						
Output Breakdown Voltage	V <sub>B</sub>	I <sub>B</sub> = 50μA	350			V
Output Off-State Leakage	I <sub>TOFF</sub>	V <sub>T</sub> = 100V, I <sub>F</sub> = 0mA		0.2	2	μA
I/O Capacitance	C <sub>ISO</sub>	I <sub>F</sub> = 0, f = 1MHz		6		pF
ON Resistance	R <sub>ON</sub>	I <sub>L</sub> = 100mA, I <sub>F</sub> = 10mA		28	35	Ω
Turn-On Time	T <sub>ON</sub>	I <sub>F</sub> = 10mA, V <sub>L</sub> = ±20V		0.1	0.5	mS
Turn-Off Time	T <sub>OFF</sub>	t = 10mS, I <sub>L</sub> = ±100mA		0.3	0.5	mS

## MOS Relay Schematic and Wiring Diagrams

Type	Schematic	Output configuration	Load	Connection	Wiring Diagrams
L-3524S		1a	AC/DC	-	



## Data Curve

**Fig.1** Load current vs. ambient temperature  
Allowable ambient temperature:  
-40°C to +85°C

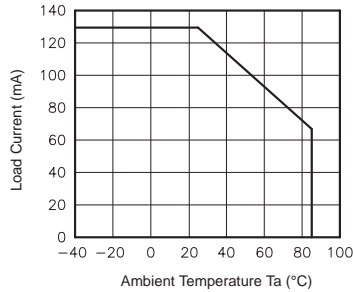

**Fig.2** On resistance vs. ambient temperature  
Across terminals 3 and 4 pin  
LED current: 5mA  
Continuous load current: 130mA(DC)

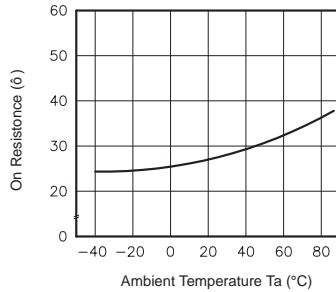

**Fig.3** Turn on time vs. ambient temperature  
Load voltage 350V(DC)  
LED current: 5mA  
Continuous load current: 130mA(DC)

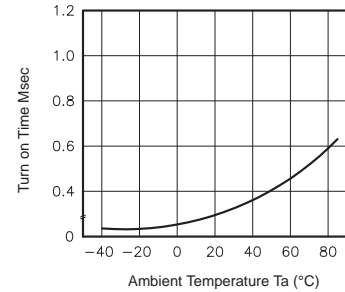

**Fig.4** Turn off time vs. ambient temperature  
LED current: 5mA; Load voltage:  
350V(DC)  
Continuous load current: 130mA(DC)

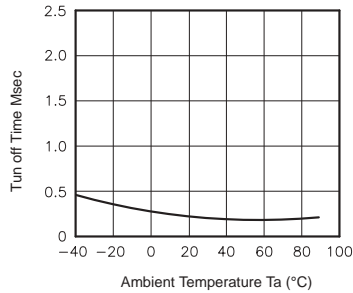

**Fig.5** LED operate vs. ambient temperature  
Load voltage 350V(DC)  
Continuous load current: 130mA(DC)

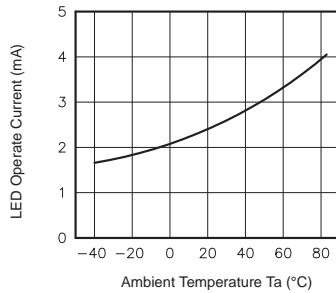

**Fig.6** LED turn off current vs. ambient temperature  
Load voltage 350V(DC)  
Continuous load current: 130mA(DC)

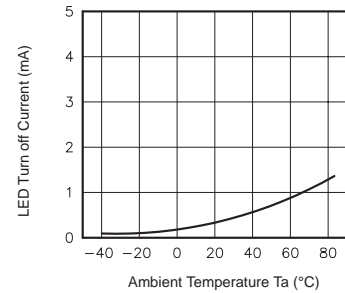

**Fig.7** LED dropout voltage vs. ambient temperature  
LED current: 5 to 50mA

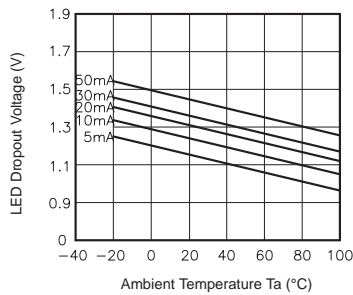

**Fig.8** Voltage vs. current characteristics of output at MOS FET portion  
Measured portion: across terminals 3 and 4 pin  
Ambient temperature: 25°C

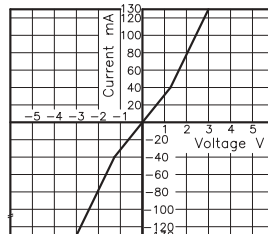

**Fig.9** Off state leakage current  
Across terminals 3 and 4 pin  
Ambient temperature: 25°C

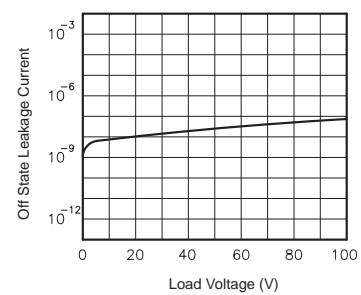

**Fig.10** LED forward current vs. turn on time  
Across terminals 3 and 4 pin;  
Load voltage: 350V (DC);  
Continuous load current: 130mA (DC);  
Ambient temperature: 25°C

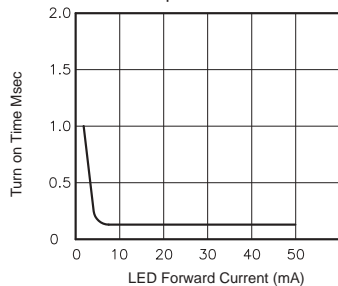

**Fig.11** LED forward current vs. turn off time  
Across terminals 3 and 4 pin;  
Load voltage: 350V (DC);  
Continuous load current: 130mA (DC);  
Ambient temperature: 25°C

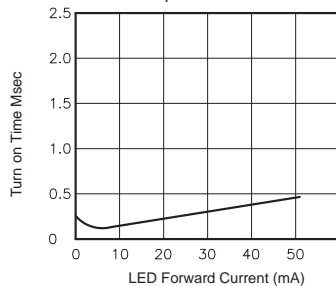

**Fig.12** Applied voltage vs. output capacitance  
Across terminals 3 and 4 pin  
Frequency: 1MHz  
Ambient temperature: 25°C

