

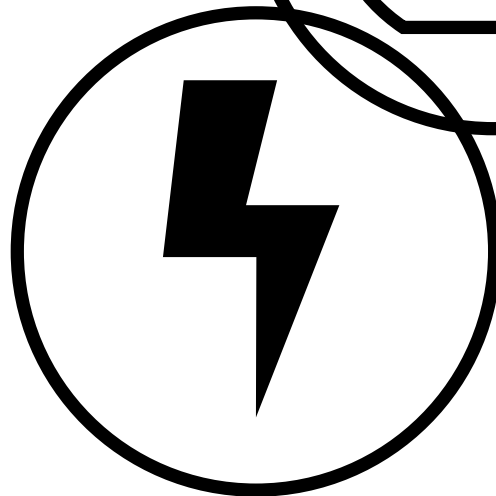

WORLD PRODUCTS INC.
ELECTRONIC COMPONENT SOLUTIONS

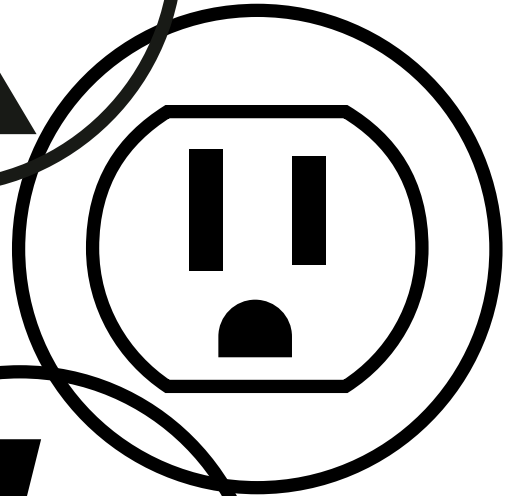

FERRITE BEADS

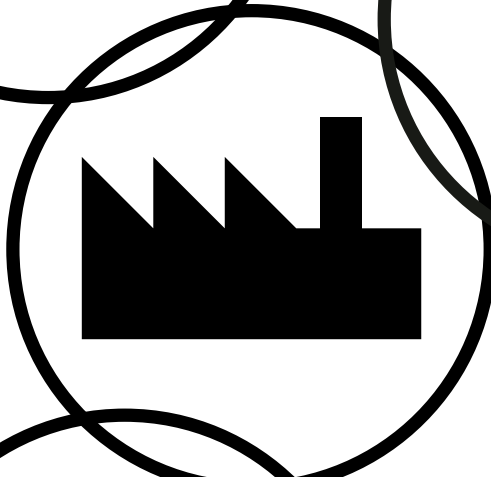
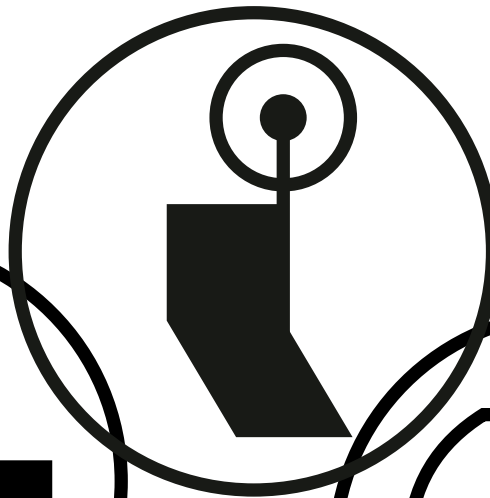
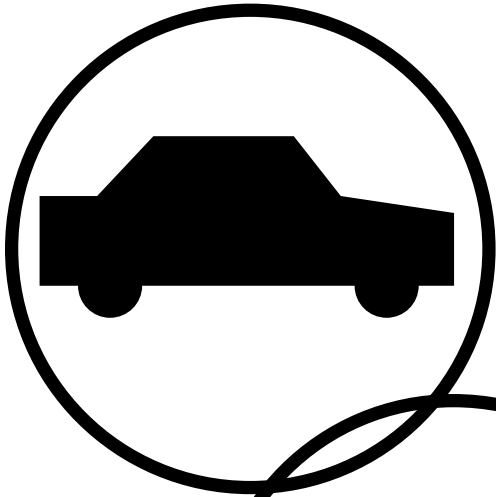

CHIP FERRITE BEADS

Features

1. Effective in suppressing noise at high frequencies.
2. Suited for preventing the abnormal oscillation from high frequency amplifying circuits.
3. Excellent solder heat resistance for soldering.
4. Highly reliability in circuits of high-current.
5. Nickel barrier termination.
6. RoHS compliant with Directive 2002/95/EC of the European Parliament and of the Council of 27 January 2003 on the restriction of the use of certain hazardous substances in electrical and electronic equipment (RoHS Directive) and comply to a maximum concentration value of 0.1% by weight in homogeneous materials for lead (Pb), mercury, hexavalent chromium, polybrominated biphenyls (PBB) and polybrominated diphenyl ethers (PBDE) and of 0.01% weight in homogeneous materials for cadmium.

Applications

1. Noise suppression in digital equipments.
2. Computers and peripheral devices, VCR and camera.
3. Noise suppression in automotive electronic equipments, car stereo, car engine controller.
4. Noise suppression for OA electronic instruments.

Ordering Information

WPB - M 1608 - 121 T
(1) (2) (3) (4) (5)

(1) Series

WPB: For Signal line
WPBH: For high current(~3.0A)
WPBU: For ultra high current(~6.0A)

(2) Material & Design

L, Y: For ultra high speed
S, B: For high speed
H,C: For general purpose
M: For high impedance type
T: For Low speed

(3) Dimension*

First two digits: length (mm)
Last two digits: width (mm)

(4) Impedance (at 100MHz)

First two digits are impedance values.
 Last digit is the number of zeros.

(5) Packaging

B: Bulk Package
T: Tape & Reel (Φ 178mm [7 inch])
L: Tape & Reel (Φ 254mm [10 inch])

*0603(mm) is equivalent to 0201(inches).
 1005(mm) is equivalent to 0402(inches).
 1608(mm) is equivalent to 0603(inches).
 2012(mm) is equivalent to 0805 (inches).
 3216(mm) is equivalent to 1206 (inches).
 4516(mm) is equivalent to 1806(inches).
 4532(mm) is equivalent to 1812(inches).
 5750(mm) is equivalent to 2220(inches).

Shape & Dimensions

Unit : mm [inches]

Type	L	W	T	C ₁
WPB□-□0603	0.6±0.03 [.024±.001]	0.3±0.03 [.012±.001]	0.3±0.03 [.012±.001]	0.15±0.05 [.006±.002]
WPB□-□1005	1.0±0.05 [.039±.002]	0.5±0.05 [.020±.002]	0.5±0.05 [.020±.002]	0.20±0.10 [.008±.004]
WPB□-□1608	1.6±0.15 [.063±.006]	0.8±0.15 [.031±.006]	0.8±0.15 [.031±.006]	0.30±0.20 [.012±.008]
WPB□-□2012	2.0±0.20 [.079±.008]	1.25±0.20 [.049±.008]	1.0±0.20 [.039±.008]	0.50±0.30 [.020±.012]
	2.0±0.20 [.079±.008]	1.25±0.20 [.049±.008]	*1.25±0.20 [.049±.008]	0.50±0.30 [.020±.012]
WPB□-□3216	3.2±0.20 [.126±.008]	1.6±0.20 [.063±.008]	1.3±0.20 [.051±.008]	0.50±0.30 [.020±.012]
WPB□-□4516	4.5±0.25 [.177±.010]	1.6±0.20 [.063±.008]	1.3±0.20 [.051±.008]	0.50±0.30 [.020±.012]
WPB□-□4532	4.5±0.25 [.177±.010]	3.2±0.25 [.126±.010]	1.3±0.25 [.051±.010]	0.70±0.40 [.027±.016]
WPB□-□5750	5.7±0.30 [.225±.012]	5.0±0.30 [.198±.012]	1.6±0.25 [0.63±.010]	0.80±0.50 [.031±.020]

*Only WPBU Series

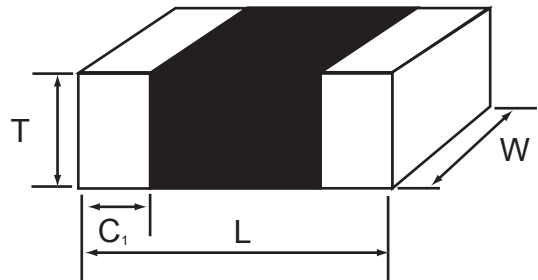

CHIP FERRITE BEADS

Specifications

WPB Series (For signal Line)

WPB 0603 Series

Part No.	IZI at 100 MHz(Ω)		DCR(Ω) max.	Rated current (mA) max.
	typ.	min.		
WPB-T0603-800□	80	60	0.5	500
WPB-T0603-121□	120	90	0.8	200
WPB-T0603-241-□	240	180	1.0	200

WPB 1005 Series

Part No.	IZI at 100 MHz(Ω)		DCR(Ω) max.	Rated current (mA) max.
	typ.	min.		
WPB-H1005-100□	10	7.5	0.05	1000
WPB-M1005-400□	40	30	0.15	900
WPB-M1005-600□	60	45	0.20	650
WPB-M1005-800□	80	60	0.20	650
WPB-M1005-121□	120	90	0.30	500
WPB-M1005-221□	220	165	0.35	500
WPB-M1005-301□	300	225	0.45	400
WPB-M1005-471□	470	355	0.55	300
WPB-M1005-601□	600	450	0.60	300
WPB-M1005-102□	1000	750	1.30	250
WPB-T1005-100□	10	7.5	0.05	1000
WPB-T1005-260□	26	19.5	0.10	900
WPB-T1005-400□	40	30	0.10	900
WPB-T1005-600□	60	45	0.20	650
WPB-T1005-700□	70	53	0.20	650
WPB-T1005-800□	80	60	0.25	550
WPB-T1005-121□	120	90	0.25	500
WPB-T1005-221□	220	165	0.35	500
WPB-T1005-241□	240	180	0.40	400
WPB-T1005-301□	300	225	0.45	400
WPB-T1005-601□	600	450	0.60	400
WPB-S1005-100□	10	7.5	0.10	500
WPB-S1005-300□	30	23	0.20	400
WPB-S1005-600□	60	45	0.30	350
WPB-S1005-101□	100	75	0.35	300
WPB-S1005-121□	120	90	0.40	300

CHIP FERRITE BEADS

Specifications

WPB 1608 Series

Part No.	IZI at 100 MHz(Ω)		DCR(Ω)	Rated current (mA) max.
	typ.	min.	max.	
WPB-H1608-300□	30	22	0.08	500
WPB-M1608-600□	60	45	0.09	200
WPB-M1608-800□	80	60	0.10	200
WPB-M1608-121□	120	90	0.12	200
WPB-M1608-221□	220	165	0.20	200
WPB-M1608-301□	300	225	0.30	200
WPB-M1608-501□	500	375	0.40	200
WPB-M1608-601□	600	450	0.40	200
WPB-M1608-801□	800	600	0.60	200
WPB-M1608-102□	1000	750	0.60	150
WPB-S1608-100□	10	7.5	0.05	300
WPB-S1608-200□	20	15	0.12	300
WPB-S1608-300□	30	22	0.12	300
WPB-S1608-400□	40	30	0.12	300
WPB-S1608-550□	55	42	0.15	200
WPB-S1608-800□	80	60	0.25	200
WPB-S1608-121□	120	90	0.25	200
WPB-S1608-221□	220	165	0.40	200
WPB-T1608-260□	26	20	0.05	500
WPB-T1608-300□	30	22	0.05	500
WPB-T1608-600□	60	45	0.10	400
WPB-T1608-800□	80	60	0.10	300
WPB-T1608-121□	120	90	0.20	250
WPB-T1608-221□	220	165	0.30	200
WPB-T1608-301□	300	225	0.35	200
WPB-T1608-331□	330	250	0.35	200
WPB-T1608-601□	600	450	0.50	200
WPB-T1608-102□	1000(at 60MHz)	750	0.70	200
WPB-T1608-202□	2000(at 70MHz)	1500	1.20	100
WPB-B1608-222□	2200	1650	0.85	200

CHIP FERRITE BEADS

Specifications

WPB 2012 Series

Part No.	IZI at 100 MHz(Ω)		DCR(Ω) max.	Rated current (mA) max.
	typ.	min.		
WPB-H2012-150□	15	12	0.02	600
WPB-H2012-260□	26	20	0.02	600
WPB-H2012-300□	30	23	0.02	600
WPB-H2012-320□	32	24	0.03	600
WPB-M2012-800□	80	60	0.08	300
WPB-M2012-121□	120	90	0.10	300
WPB-M2012-151□	150	115	0.12	300
WPB-M2012-221□	220	165	0.12	300
WPB-M2012-301□	300	225	0.15	300
WPB-M2012-451□	450	338	0.25	300
WPB-M2012-601□	600	450	0.25	300
WPB-M2012-102□	1000	750	0.30	300
WPB-M2012-202□	2000 (at 70MHz)	1500	0.50	300
WPB-M2012-252□	2500 (at 50MHz)	1875	0.60	300
WPB-S2012-5R0□	5	3.5	0.05	300
WPB-S2012-8R0□	8	6	0.05	300
WPB-S2012-400□	40	30	0.15	250
WPB-S2012-800□	80	6	0.05	300
WPB-S2012-121□	120	90	0.20	300
WPB-S2012-221□	220	165	0.30	300
WPB-S2012-251□	250	190	0.50	300
WPB-T2012-260□	26	20	0.04	600
WPB-T2012-400□	40	30	0.05	600
WPB-T2012-800□	80	60	0.08	300
WPB-T2012-121□	120	90	0.08	300
WPB-T2012-151□	150	115	0.08	300
WPB-T2012-221□	220	170	0.12	200
WPB-T2012-301□	300	225	0.15	200
WPB-T2012-331□	330	250	0.15	200
WPB-T2012-401□	400	300	0.15	200
WPB-T2012-601□	600	450	0.25	200
WPB-T2012-102□	1000 (at 60MHz)	750	0.30	200
WPB-T2012-202□	2000 (at 40MHz)	1500	0.50	200
WPB-T2012-252□	2500 (at 35MHz)	1875	0.60	200
WPB-B2012-222□	2200	1650	0.60	300
WPB-B2012-272□	2700	2025	0.70	300

CHIP FERRITE BEADS

Specifications

WPB 3216 Series

Part No.	IZI at 100 MHz(Ω)		DCR(Ω)	Rated current (mA) max.
	typ.	min.	max.	
WPB-C3216-350□	35	26	0.02	600
WPB-H3216-500□	50	37	0.03	600
WPB-H3216-700□	70	52	0.05	600
WPB-M3216-121□	120	90	0.05	300
WPB-M3216-151□	150	115	0.05	300
WPB-M3216-201□	200	150	0.08	300
WPB-M3216-301□	300	225	0.09	200
WPB-M3216-601□	600	450	0.20	200
WPB-M3216-102□	1000	750	0.25	200
WPB-S3216-100□	10	7.5	0.05	300
WPB-S3216-200□	20	15	0.10	300
WPB-S3216-800□	80	60	0.25	200
WPB-S3216-251□	250	190	0.30	200
WPB-S3216-601□	600	450	0.40	200
WPB-T3216-350□	35	26	0.03	600
WPB-T3216-500□	50	37	0.03	600
WPB-T3216-700□	70	52	0.05	400
WPB-T3216-800□	80	60	0.05	400
WPB-T3216-121□	120	90	0.10	300
WPB-T3216-151□	150	115	0.10	300
WPB-T3216-201□	200	150	0.15	300
WPB-T3216-601□	600	450	0.30	200
WPB-T3216-801□	800	600	0.30	200
WPB-T3216-102□	1000 (at 60MHz)	750	0.40	200
WPB-T3216-122□	1200 (at 50MHz)	900	0.40	200
WPB-T3216-202□	2000 (at 30MHz)	1500	0.50	200

WPB 4516 Series

Part No.	IZI at 100 MHz(Ω)		DCR(Ω)	Rated current (mA) max.
	typ.	min.	max.	
WPB-H4516-600□	60	45	0.02	600
WPB-H4516-700□	70	52	0.03	600
WPB-M4516-151□	150	115	0.05	300
WPB-T4516-700□	70	52	0.05	600

WPB 4532 Series

Part No.	IZI at 100 MHz(Ω)		DCR(Ω)	Rated current (mA) max.
	typ.	min.	max.	
WPB-H4532-121□	120	90	0.04	600
WPB-H4532-151□	150	115	0.04	600
WPB-T4532-800□	80	60	0.04	600
WPB-T4532-121□	120	90	0.04	600

CHIP FERRITE BEADS

Specifications

WPB 5750 Series

Part No.	IZI at 100 MHz(Ω)		DCR(Ω)	Rated current (mA) max.
	typ.	min.	max.	
WPB-M5750-181□	180	135	0.08	600

WPB Series – L type (For ultra high frequency signal line)

Part no.	IZI AT 100Mz (Ω)	IZI at 1 GHz (Ω)	DCR (Ω)	Rated current (mA) max.
	typ.	typ.	max.	
WPB-L1608-2R0□	2.0	20	0.20	300
WPB-L1608-4R0□	4.0	40	0.25	300
WPB-L1608-5R5□	5.5	55	0.30	300
WPB-L1608-7R0□	7.0	80	0.30	300
WPB-L1608-9R0□	9.0	40 (at 500MHz)	0.40	300
WPB-L1608-110□	11.0	55 (at 500MHz)	0.40	300
WPB-L1608-130□	13.0	70 (at 500MHz)	0.50	300
WPB-L1608-150□	15.0	80 (at 500MHz)	0.50	300
WPB-L2012-3R5□	3.5	30	0.15	500
WPB-L2012-6R5□	6.5	30 (at 500MHz)	0.20	500
WPB-L2012-100□	10.0	50 (at 500MHz)	0.25	500

WPB Series – Y type (For ultra high frequency signal line)

Part no.	IZI AT 100Mz (Ω)	IZI at 1 GHz (Ω)	DCR (Ω)	Rated current (mA) max.
	typ.	typ.	max.	
WPB-Y1608-4R0□	4.0	40	0.20	300
WPB-Y1608-8R0□	8.0	80	0.25	300
WPB-Y1608-100□	10.0	100	0.30	300
WPB-Y1608-150□	15.0	75 (at 500MHz)	0.35	300
WPB-Y1608-200□	20.0	120 (at 500MHz)	0.40	300

CHIP FERRITE BEADS

Specifications

WPBH Series (For High Current)

WPBH 1005 Series

Part No.	IZI at 100 MHz(Ω)		DCR(Ω)	Rated current (mA) max.
	typ.	min.	max.	
WPBH-H1005-100□	10	7.5	0.05	1300
WPBH-M1005-221□	220	165	0.35	800
WPBH-M1005-471□	470	355	0.56	500
WPBH-M1005-601□	600	450	0.60	500
WPBH-M1005-102□	1000	750	0.80	400
WPBH-S1005-100□	10	7.5	0.08	1300
WPBH-T1005-100□	10	7.5	0.05	1300
WPBH-T1005-121□	120	90	0.25	800
WPBH-T1005-241□	240	180	0.31	650
WPBH-T1005-601□	600	450	0.58	500

WPBH 1608 Series

Part No.	IZI at 100 MHz(Ω)		DCR(Ω)	Rated current (mA) max.
	typ.	min.	max.	
WPBH-H1608-300□	30	22	0.06	2000
WPBH-M1608-600□	60	45	0.09	1600
WPBH-M1608-121□	120	90	0.14	1100
WPBH-M1608-221□	221	165	0.20	1000
WPBH-M1608-301□	300	225	0.30	900
WPBH-M1608-501□	500	375	0.35	800
WPBH-M1608-601□	600	450	0.35	750
WPBH-M1608-801□	800	600	0.50	650
WPBH-M1608-102□	1000	750	0.50	550
WPBH-S1608-100□	10	7.5	0.05	1500
WPBH-S1608-200□	20	15	0.06	1400
WPBH-S1608-300□	30	22	0.10	1300
WPBH-S1608-400□	40	30	0.12	1300
WPBH-S1608-550□	55	42	0.15	1100
WPBH-S1608-800□	80	60	0.18	1000
WPBH-S1608-121□	120	90	0.20	1000
WPBH-S1608-221□	220	165	0.35	800
WPBH-T1608-260□	26	20	0.05	2000
WPBH-T1608-300□	30	22	0.05	2000
WPBH-T1608-800□	80	60	0.10	1600
WPBH-T1608-121□	120	90	0.15	1100
WPBH-T1608-221□	220	165	0.20	1000
WPBH-T1608-301□	300	225	0.30	900
WPBH-T1608-331□	330	250	0.30	800
WPBH-T1608-601□	600	450	0.40	650
WPBH-T1608-102□	1000	750	0.50	550

CHIP FERRITE BEADS

Specifications

WPBH 2012 Series

Part No.	IZI at 100 MHz(Ω)		DCR(Ω)	Rated current (mA) max.
	typ.	min.	max.	
WPBH-H2012-150□	15	12	0.02	2500
WPBH-M2012-260□	26	20	0.02	3000
WPBH-M2012-300□	30	23	0.02	2500
WPBH-M2012-320□	32	24	0.03	2500
WPBH-M2012-600□	60	45	0.03	3800
WPBH-M2012-800□	80	60	0.08	1500
WPBH-M2012-121□	120	90	0.05	2500
WPBH-M2012-151□	150	115	0.10	1500
WPBH-M2012-221□	220	165	0.05	2200
WPBH-M2012-301□	300	225	0.07	2000
WPBH-M2012-451□	450	338	0.20	1000
WPBH-M2012-601□	600	450	0.10	2000
WPBH-M2012-102□	1000	750	0.30	800
WPBH-S2012-5R0□	5.0	3.5	0.05	3000
WPBH-S2012-8R0□	8.0	6.0	0.03	3000
WPBH-S2012-400□	40	30	0.10	1800
WPBH-S2012-800□	80	60	0.15	1500
WPBH-S2012-121□	120	90	0.20	900
WPBH-S2012-221□	220	165	0.20	900
WPBH-S2012-251□	250	190	0.30	1000
WPBH-T2012-260□	26	20	0.03	3500
WPBH-T2012-400□	40	30	0.05	2000
WPBH-T2012-800□	80	60	0.08	1000
WPBH-T2012-121□	120	90	0.03	3000
WPBH-T2012-151□	150	115	0.08	1000
WPBH-T2012-221□	220	165	0.12	1000
WPBH-T2012-251□	250	190	0.05	2800
WPBH-T2012-301□	300	225	0.15	800
WPBH-T2012-331□	330	250	0.15	800
WPBH-T2012-401□	400	300	0.15	800
WPBH-T2012-601□	600	450	0.25	600
WPBH-T2012-102□	1000(at 60MHz)	750	0.30	600

CHIP FERRITE BEADS

Specifications

WPBH 3216 Series

Part No.	IZI at 100 MHz(Ω)		DCR(Ω)	Rated current (mA) max.
	typ.	min.	max.	
WPBH-H3216-500 □	50	37	0.02	4000
WPBH-H3216-700 □	70	52	0.02	4000
WPBH-M3216-900 □	90	68	0.02	4000
WPBH-M3216-121 □	120	90	0.03	4000
WPBH-M3216-151 □	150	115	0.05	2000
WPBH-M3216-201 □	200	150	0.08	2000
WPBH-M3216-301 □	300	225	0.09	2000
WPBH-M3216-501 □	500	375	0.06	3000
WPBH-M3216-601 □	600	450	0.06	3000
WPBH-M3216-102 □	1000	750	0.25	1000
WPBH-S3216-100 □	10	7.5	0.05	3000
WPBH-S3216-200 □	20	15	0.10	3000
WPBH-S3216-800 □	80	60	0.25	2000
WPBH-S3216-251 □	250	190	0.30	2000
WPBH-T3216-260 □	26	20	0.03	4000
WPBH-T3216-350 □	35	26	0.03	4000
WPBH-T3216-500 □	50	37	0.04	3000
WPBH-T3216-700 □	70	52	0.05	2500
WPBH-T3216-800 □	80	60	0.05	2500
WPBH-T3216-121 □	120	90	0.10	2000
WPBH-T3216-151 □	150	115	0.10	2000
WPBH-T3216-201 □	200	150	0.15	1800
WPBH-T3216-601 □	600	450	0.30	1000
WPBH-T3216-801 □	800	600	0.30	1000
WPBH-T3216-102 □	1000(at 60MHz)	750	0.30	1000
WPBH-T3216-122 □	1200(at 50MHz)	900	0.40	1000
WPBH-T3216-202 □	2000(at 30MHz)	1500	0.40	1000

WPBH 4516 Series

Part No.	IZI at 100 MHz(Ω)		DCR(Ω)	Rated current (mA) max.
	typ.	min.	max.	
WPBH-H4516-600□	60	45	0.02	4000
WPBH-H4516-111□	110	83	0.02	4000

WPBH 4532 Series

Part No.	IZI at 100 MHz(Ω)		DCR(Ω)	Rated current (mA) max.
	typ.	min.	max.	
WPBH-H4532-121□	120	90	0.03	3000
WPBH-T4532-121□	120	90	0.03	3000
WPBH-M4532-601□	600(at 50MHz)	450	0.04	3000
WPBH-M4532-132□	1300(at 60MHz)	980	0.05	2700
WPBH-B4532-132□	1300	980	0.05	2700

CHIP FERRITE BEADS

Specifications

WPBH 5750 Series

Part No.	IZI at 100 MHz(Ω)		DCR(Ω)	Rated current (mA) max.
	typ.	min.	max.	
WPBH-M5750-401□	400	300	0.05	2500
WPBH-M5750-501□	500	375	0.08	2500
WPBH-T5750-151□	150	115	0.05	4000

WPBU Series (For ultra high current)

WPBU 2012, 3216, 4516, 4532, 5750 Series

Part No.	IZI at 100 MHz(Ω)		DCR(Ω)	Rated current (mA) max.
	typ.	min.	max.	
WPBU-M2012-400□	40	30	0.02	5000
WPBU-M2012-600□	60	45	0.02	4800
WPBU-M2012-800□	80	60	0.02	4500
WPBU-M2012-121□	120	90	0.03	4200
WPBU-T2012-500□	50	37	0.015	5000
WPBU-H3216-500□	50	37	0.01	4800
WPBU-H3216-121□	120	90	0.02	4600
WPBU-H4516-600□	60	45	0.015	5400
WPBU-B4532-681□	680	510	0.03	3800
WPBU-H4532-121□	120	90	0.02	4600
WPBU-M5750-401□	400	300	0.03	5500

* Parts with other electrical characteristics available upon Request

* Test equipment: HP4291A + HP16192A

CHIP FERRITE BEADS

Electrical Characteristics

WPB 0603 Series

WPB-T0603-800

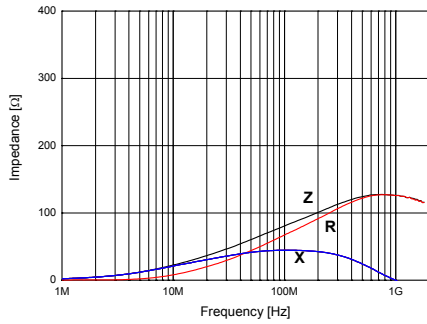

WPB-T0603-121

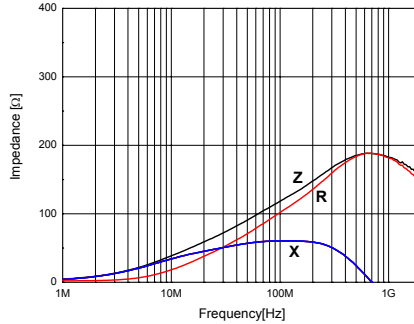

WPB-T0603-241

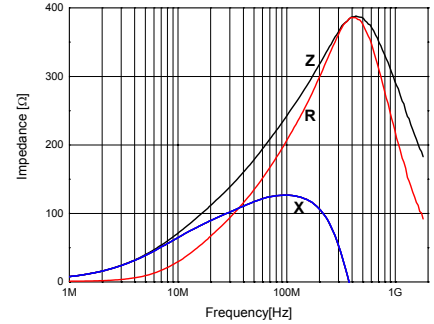

WPB 1005 Series

WPB-M1005-100

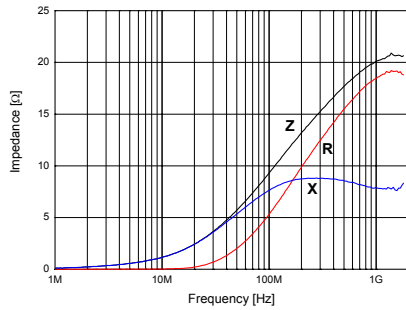

WPB-M1005-400

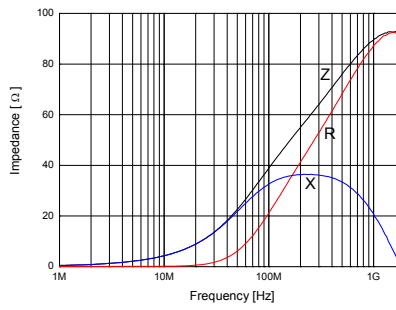

WPB-1M1005-600

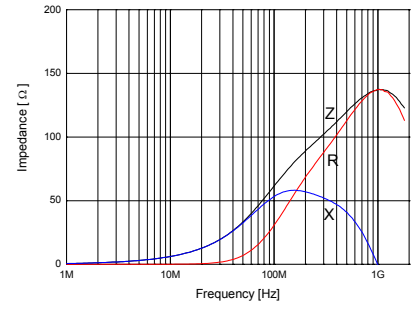

WPB-M1005-800

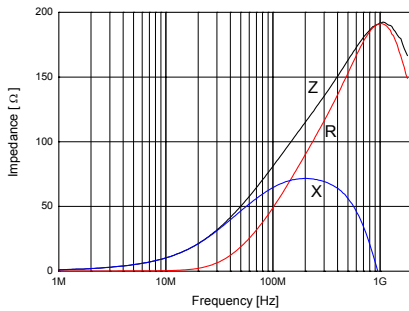

WPB-M1005-121

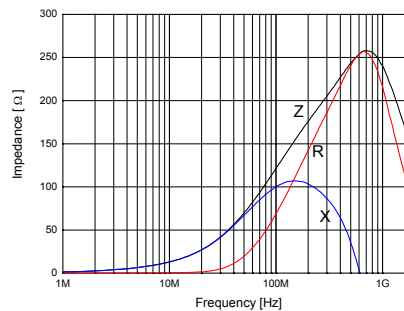

WPB-M1005-221

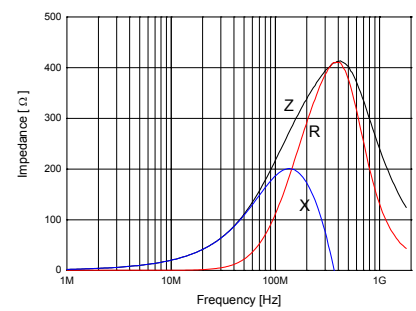

WPB-M1005-301

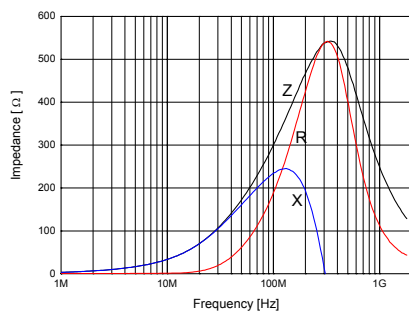

WPB-M1005-601

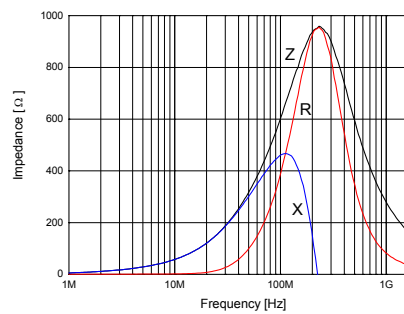

WPB-M1005-102

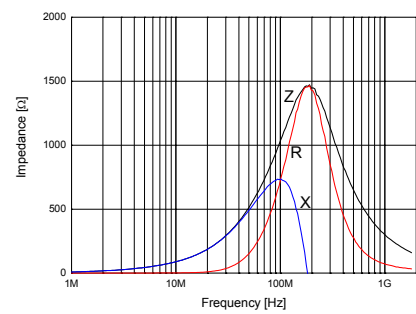

CHIP FERRITE BEADS

WPB-T1005-100

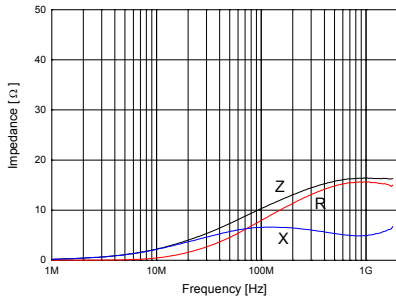

WPB-T1005-400

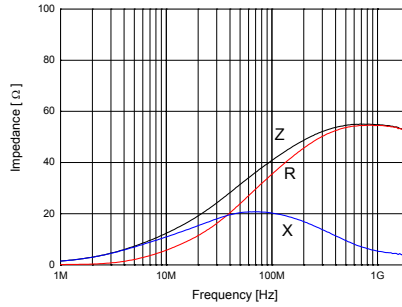

WPB-T1005-600

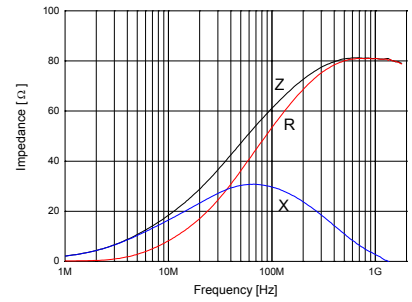

WPB-T1005-700

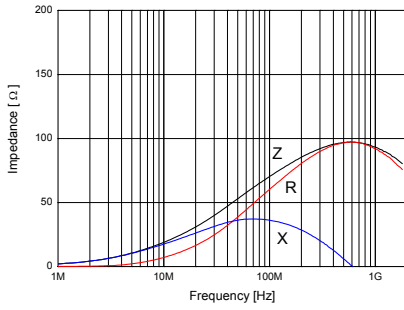

WPB-T1005-800

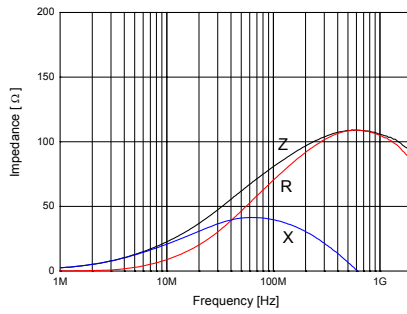

WPB-T1005-121

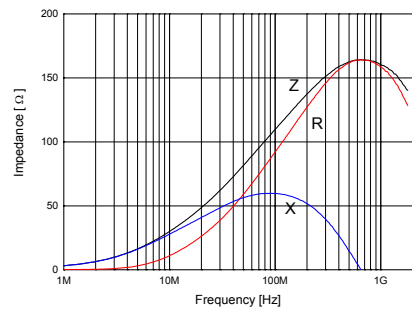

WPB-T1005-221

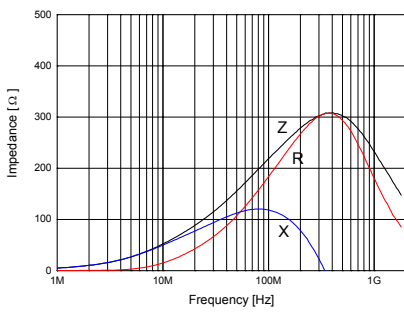

WPB-T1005-241

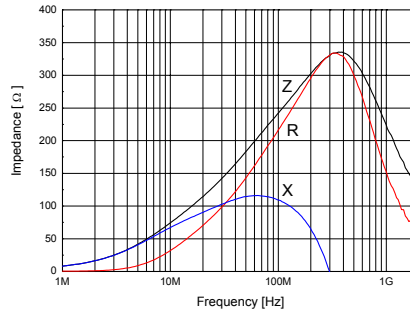

WPB-T1005-301

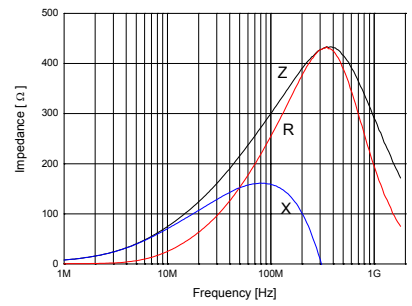

WPB-T1005-601

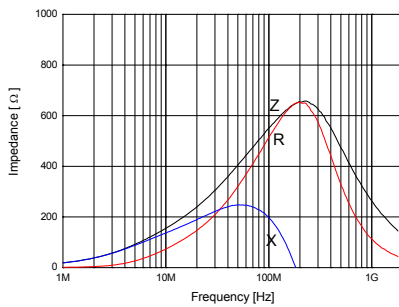

WPB-S1005-100

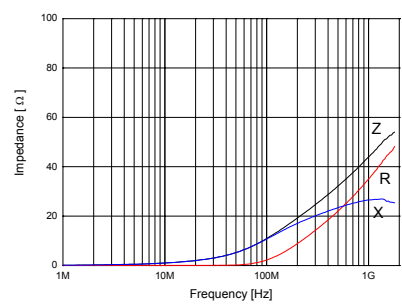

WPB-S1005-300

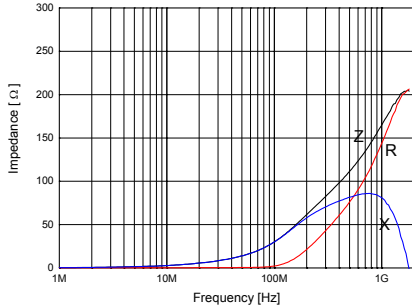

CHIP FERRITE BEADS

WPB-S1005-600

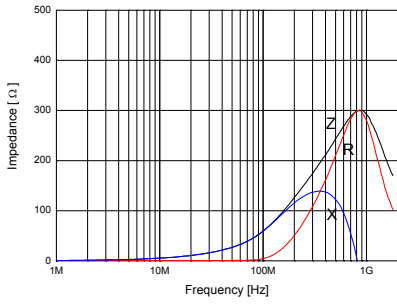

WPB-S1005-101

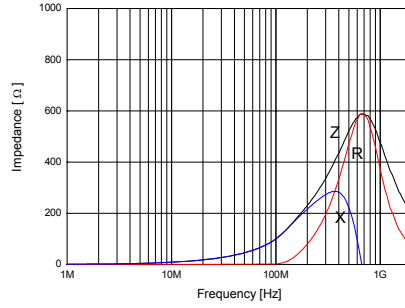

WPB-M1005-15

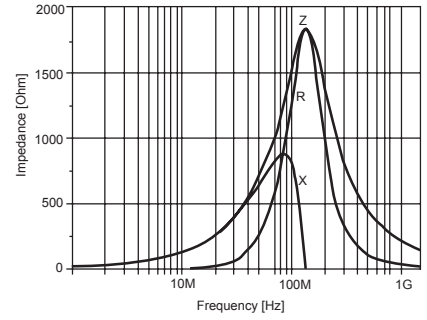

WPB 1608 Series

WPB-H1608-300

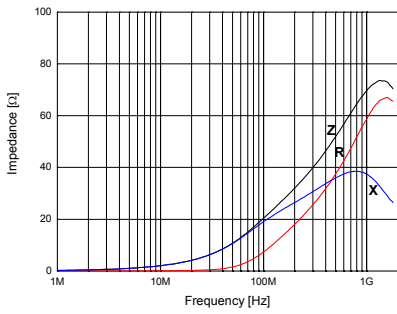

WPB-M1608-600

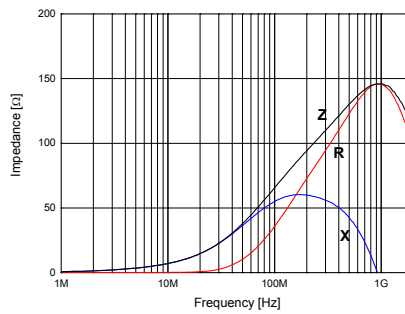

WPB-M1608-800

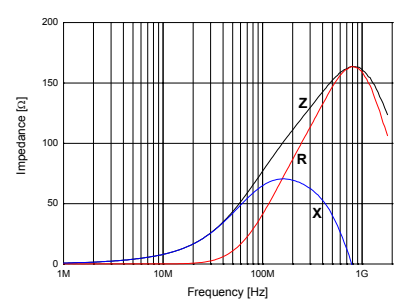

WPB-M1608-121

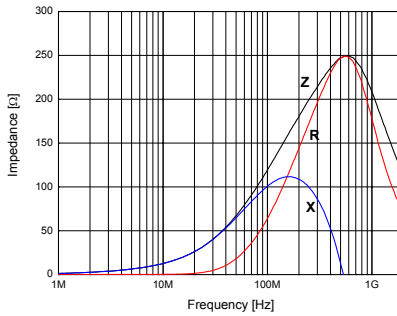

WPB-M1608-221

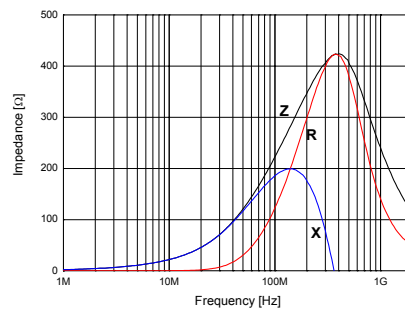

WPB-M1608-201

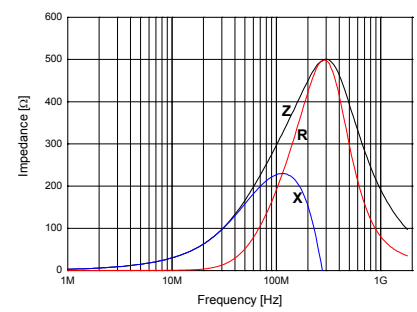

WPB-M1608-601

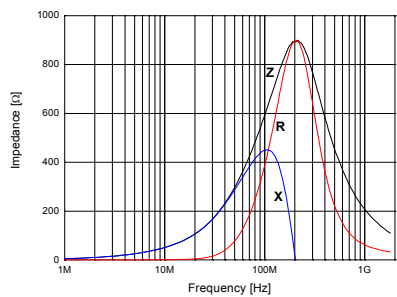

WPB-M1608-102

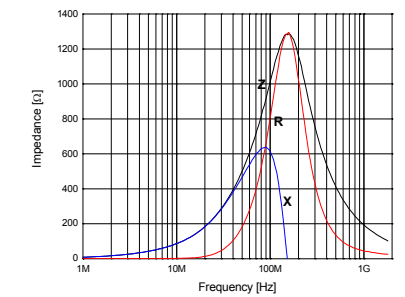

WPB-S1608-100

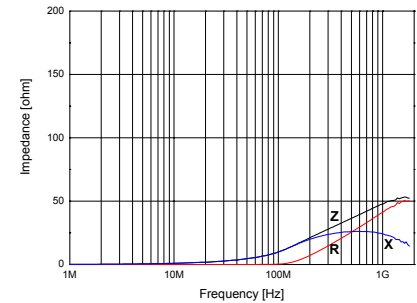

CHIP FERRITE BEADS

WPB-S1608-200

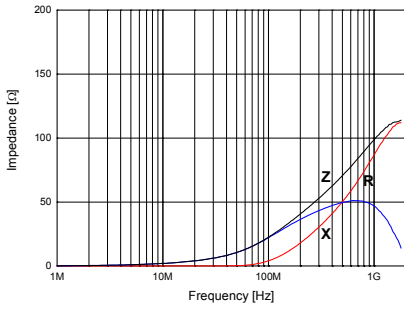

WPB-S1608-300

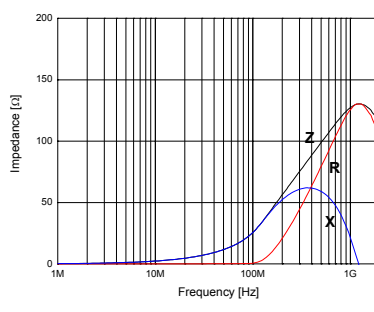

WPB-S1608-400

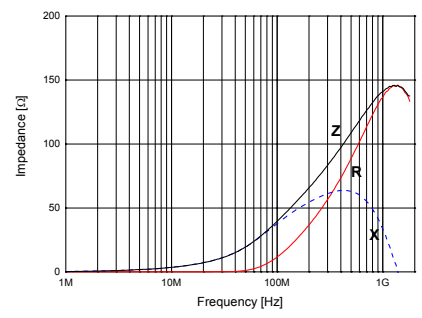

WPB-S1608-550

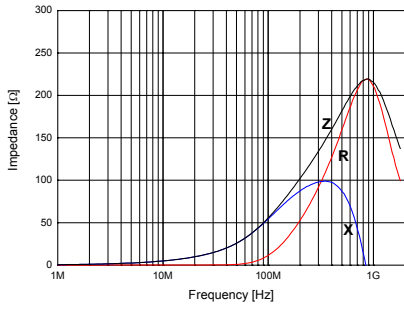

WPB-S1608-800

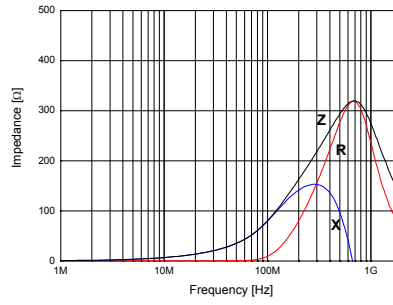

WPB-S1608-121

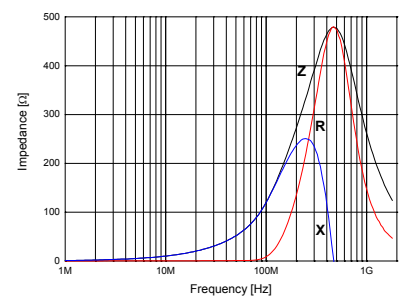

WPB-S1608-221

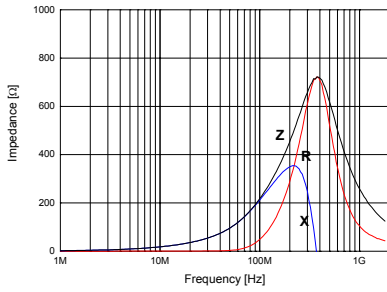

WPB-T1608-300

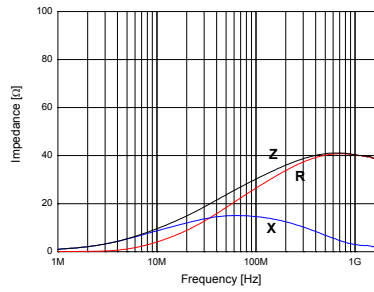

WPB-T1608-800

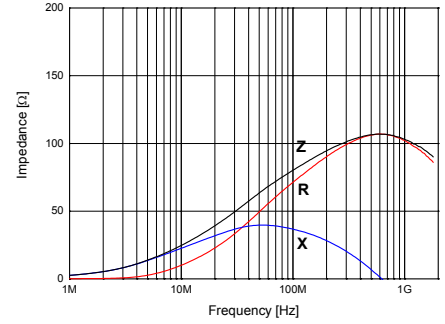

WPB-T1608-121

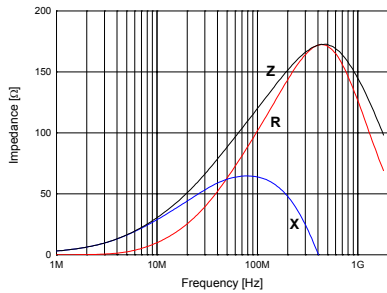

WPB-T1608-221

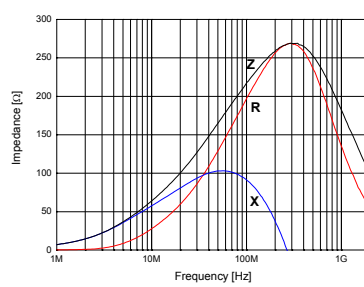

WPB-T1608-301

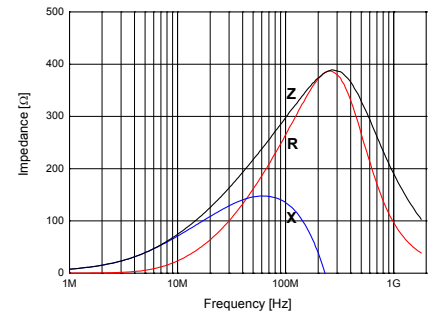

CHIP FERRITE BEADS

WPB-T1608-601

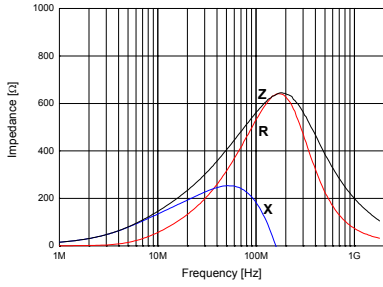

WPB-T1608-102

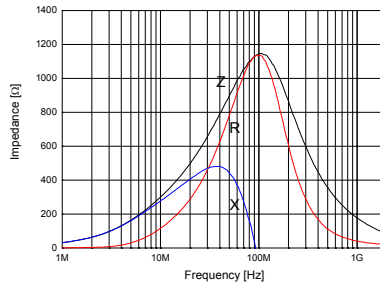

WPB-T1608-202

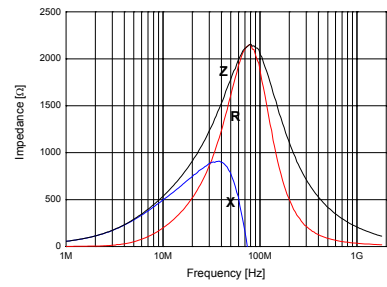

WPB-B1608-222

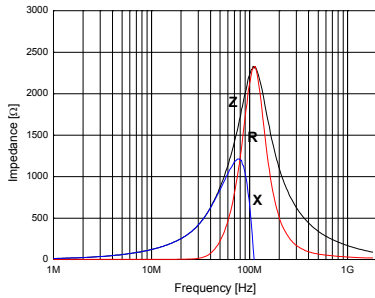

WPB-P1608-121

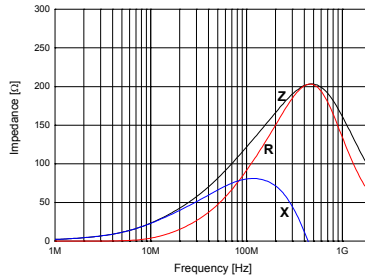

WPB 2012 Series

WPB-H2012-150

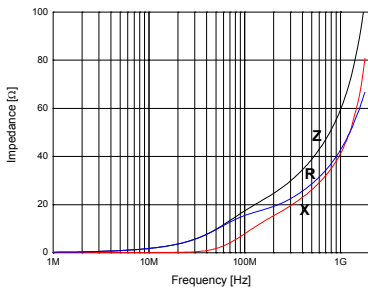

WPB-H2012-260

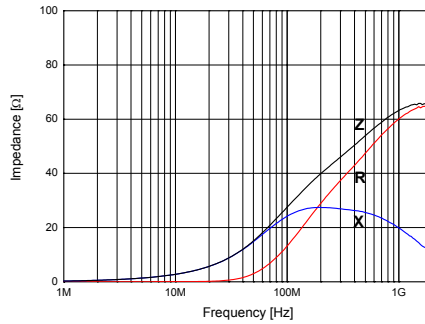

WPB-H2012-320

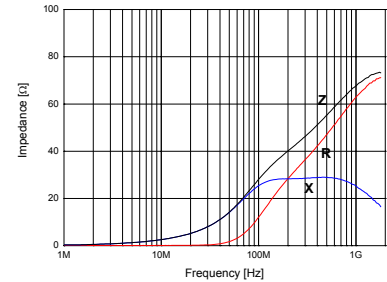

WPB-M2012-800

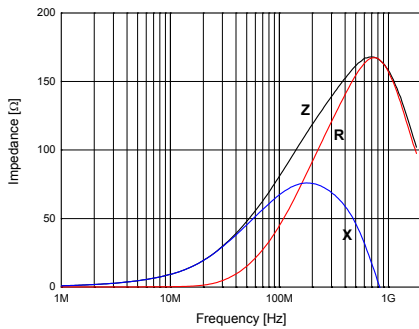

WPB-M2012-121

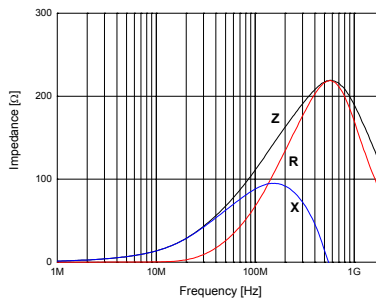

WPB-M2012-151

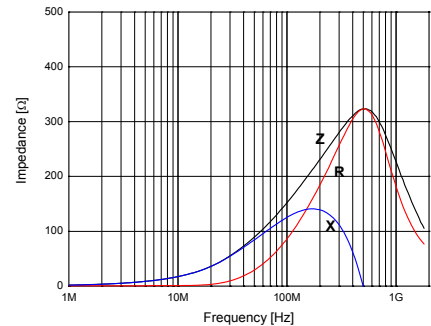

CHIP FERRITE BEADS

WPB-M2012-221

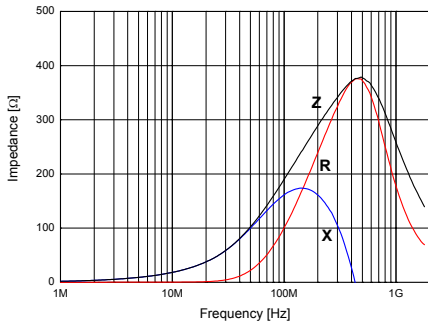

WPB-M2012-301

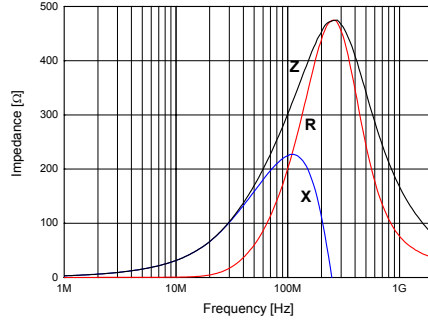

WPB-M2012-601

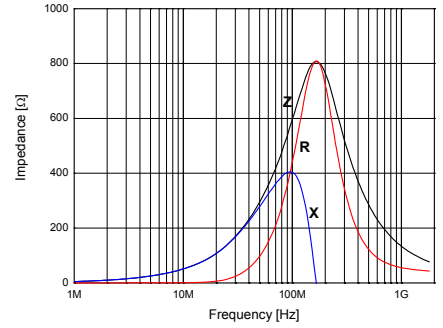

WPB-M2012-102

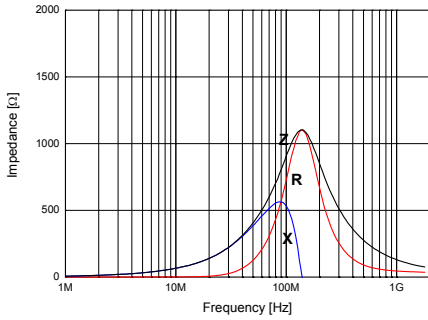

WPB-M2012-202

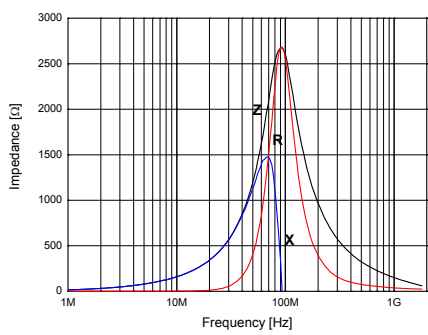

WPB-M2012-252

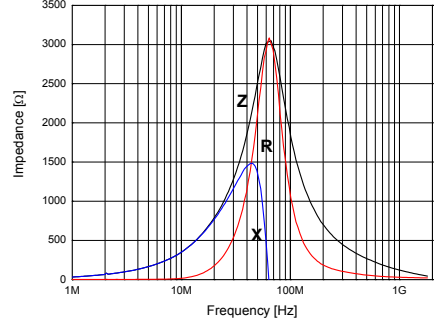

WPB-S2012-5R0

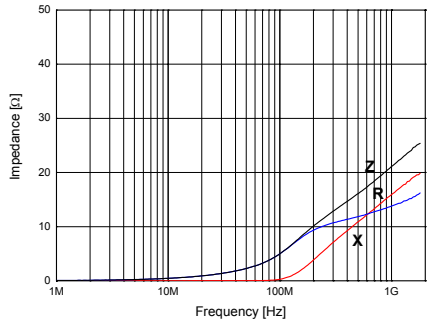

WPB-S2012-8R0

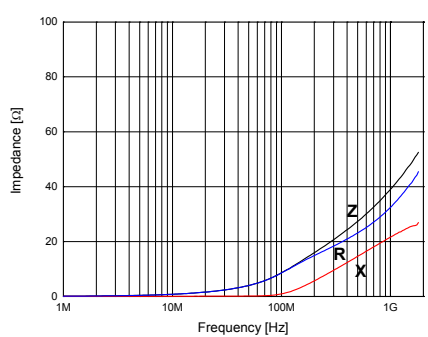

WPB-S2012-400

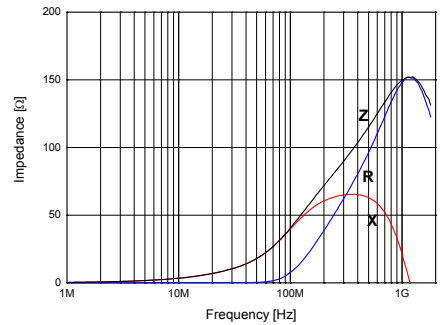

WPB-S2012-800

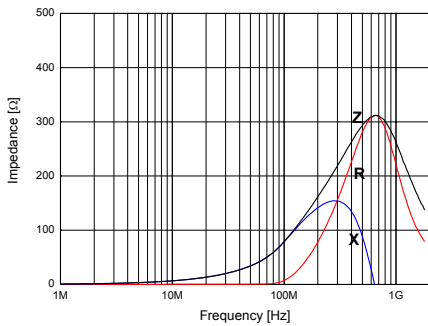

WPB-S2012-121

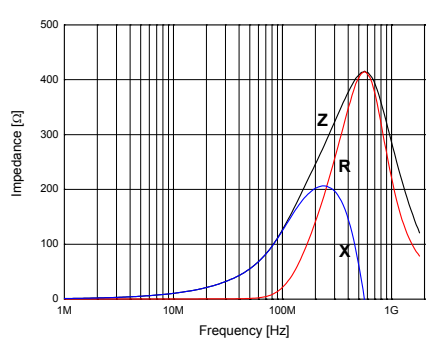

WPB-S2012-221

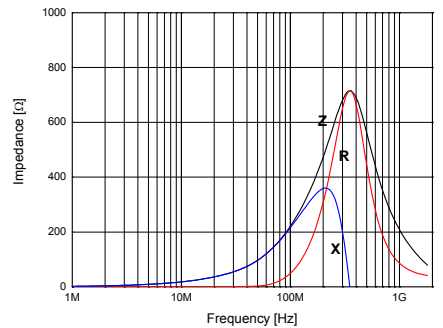

CHIP FERRITE BEADS

WPB-T2012-400

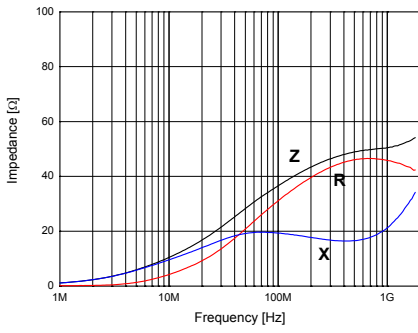

WPB-T2012-800

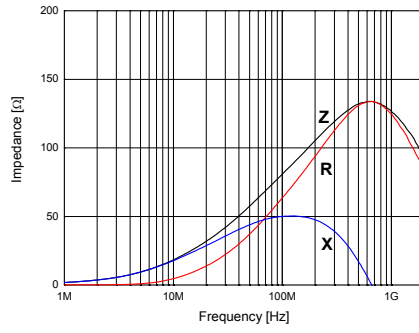

WPB-T2012-121

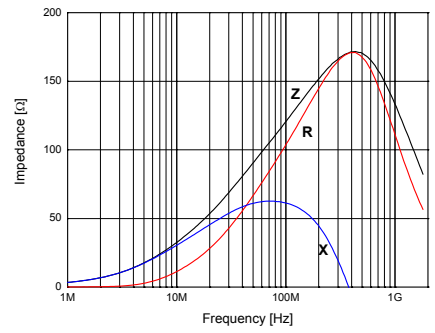

WPB-T2012-221

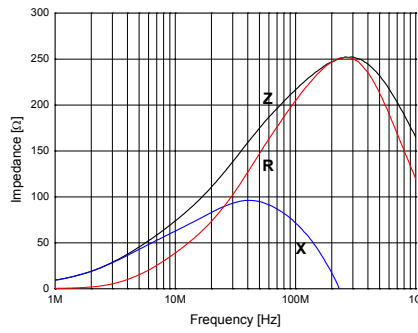

WPB-T2012-301

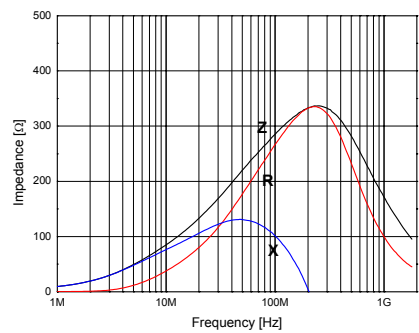

WPB-T2012-331

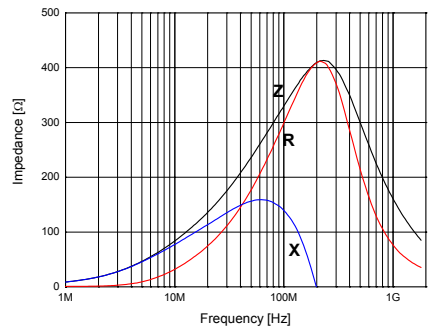

WPB-T2012-601

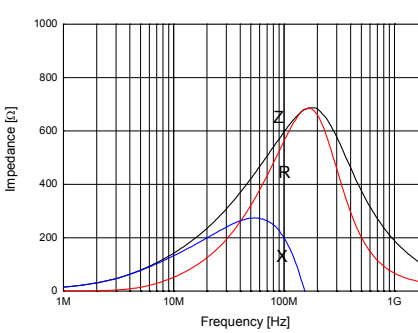

WPB-T2012-102

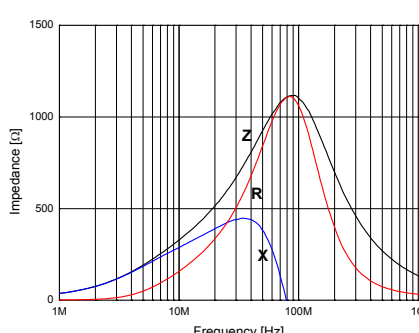

WPB-T2012-202

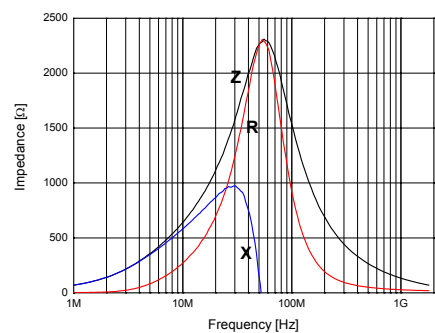

WPB-T2012-252

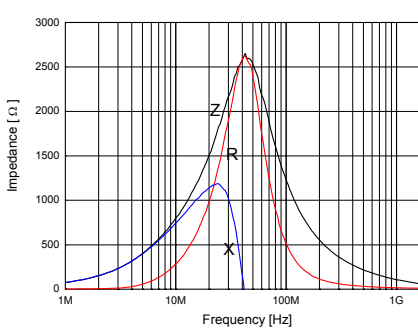

WPB-B2012-222

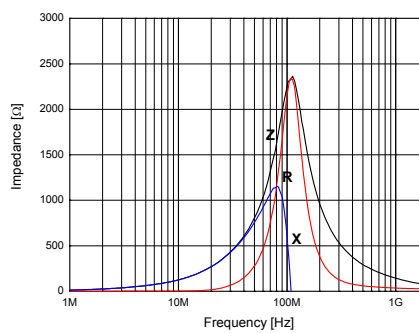

WPB-B2012-272

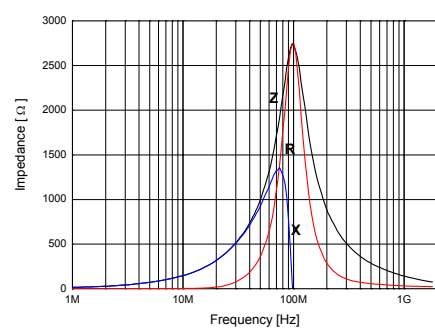

CHIP FERRITE BEADS

WPB 3216 Series

WPB-H3216-500

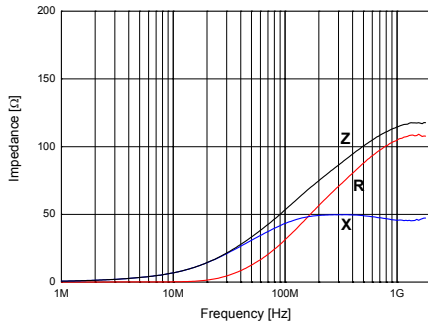

WPB-H3216-700

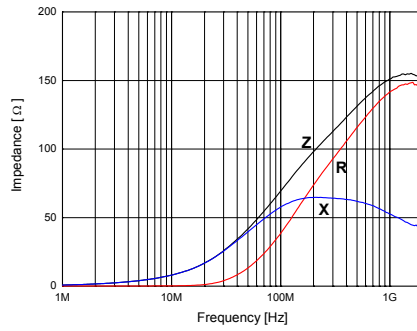

WPB-M3216-121

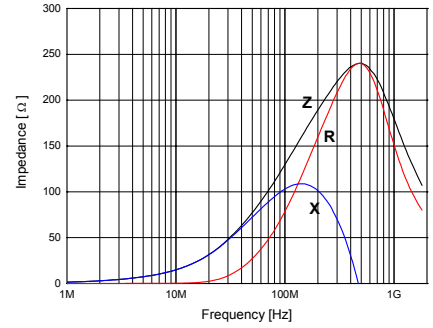

WPB-M3216-151

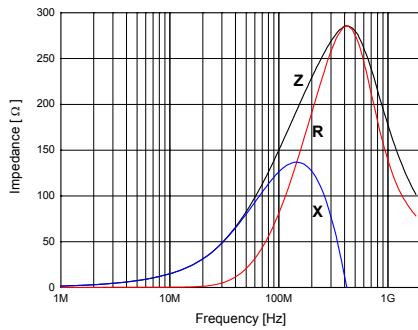

WPB-M3216-201

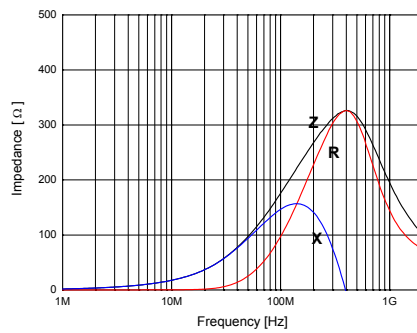

WPB-M3216-301

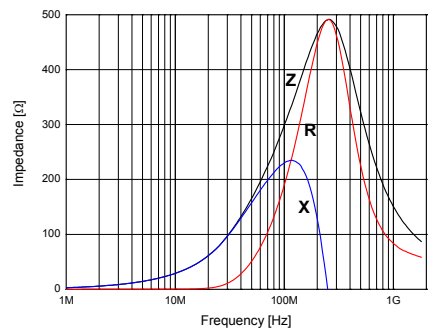

WPB-M3216-601

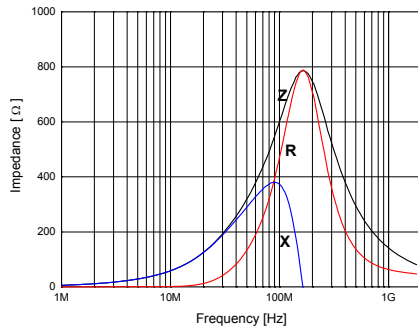

WPB-M3216-102

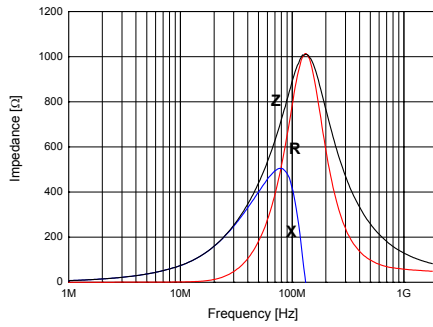

WPB-S3216-200

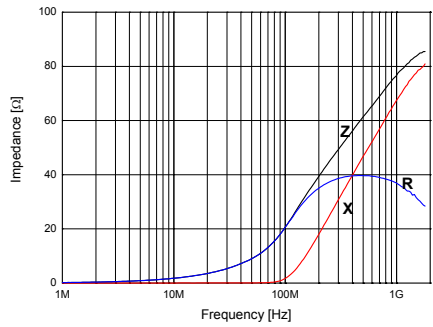

WPB-S3216-251

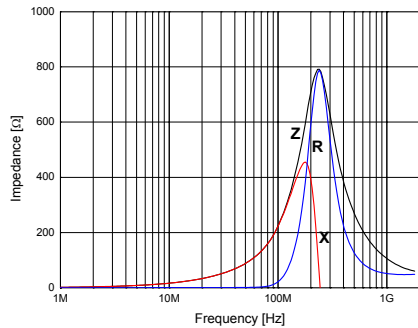

WPB-T3216-350

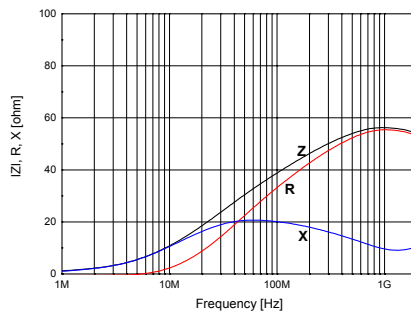

WPB-T3216-500

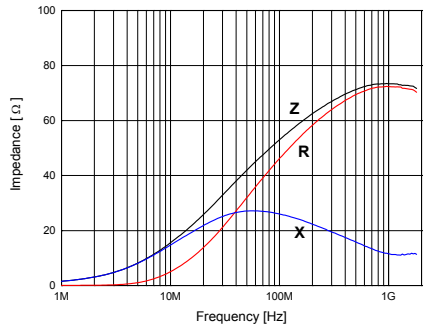

CHIP FERRITE BEADS

WPB-T3216-700

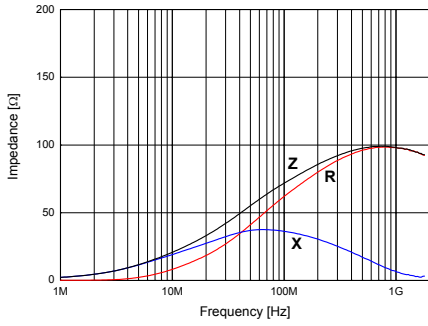

WPB-T3216-121

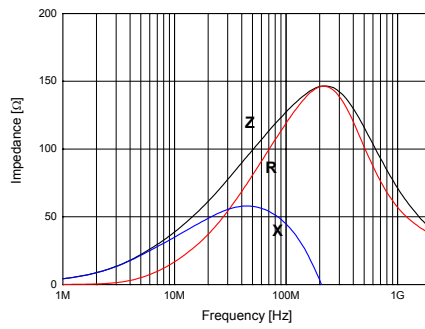

WPB-T3216-151

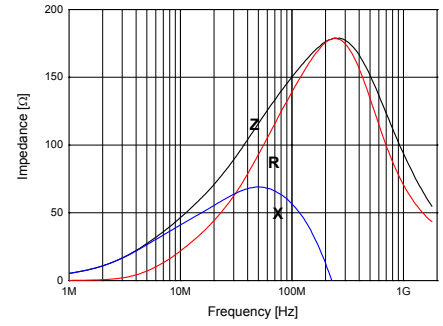

WPB-T3216-201

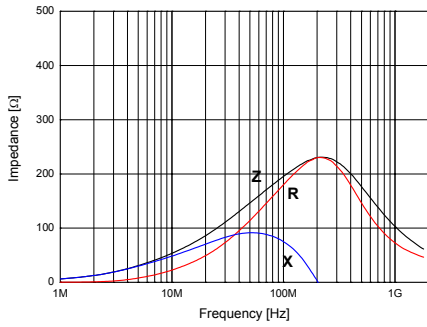

WPB-T3216-601

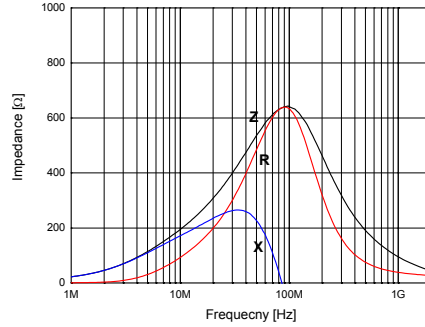

WPB-T3216-801

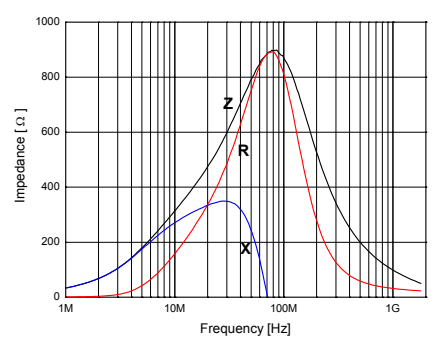

WPB-T3216-122

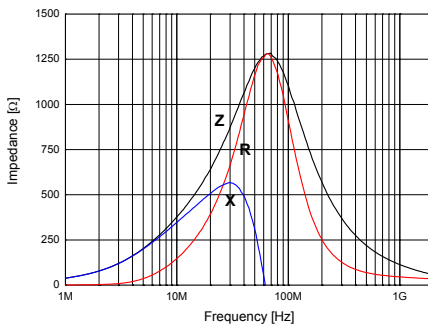

WPB-T3216-202

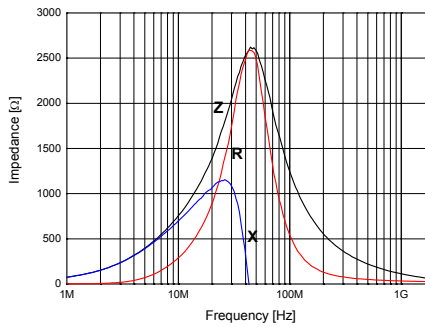

WPB-C3216-350

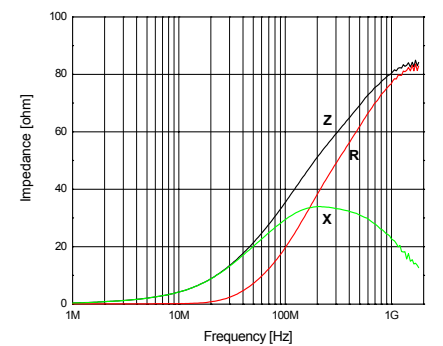

WPB 4516, 4532 Series

WPB-M4516-151

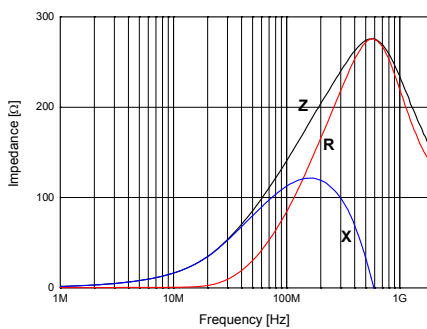

WPB-T4516-700

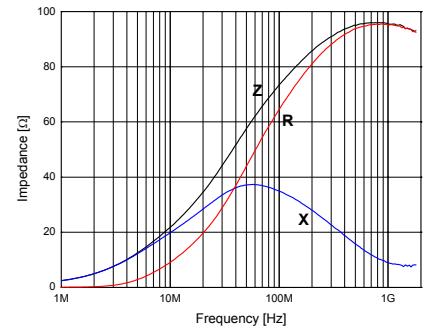

WPB-H4532-121

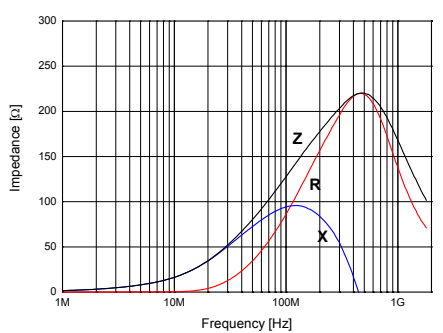

CHIP FERRITE BEADS

WPB L Series (For ultra high frequency signal line)

WPB-L1608-2R0

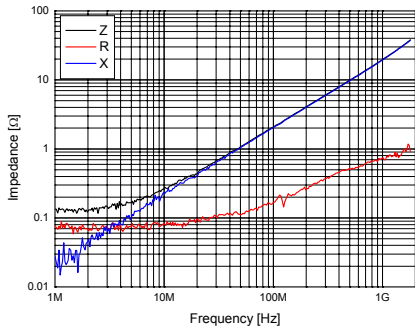

WPB-L1608-4R0

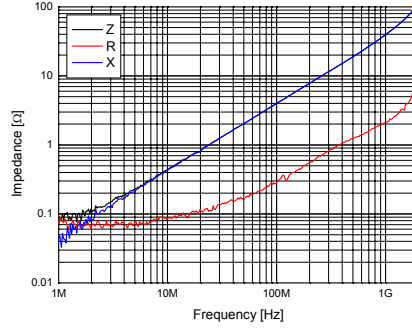

WPB-L1608-5R5

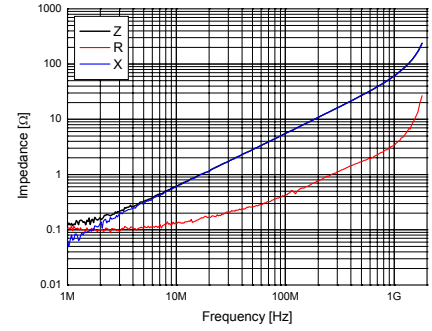

WPB-L1608-7R0

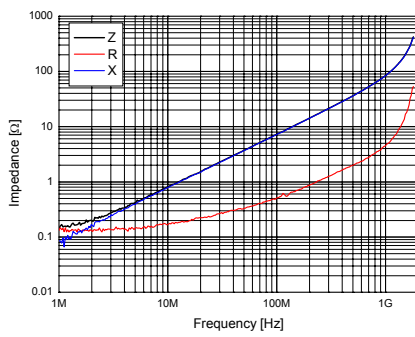

WPB-L1608-9R0

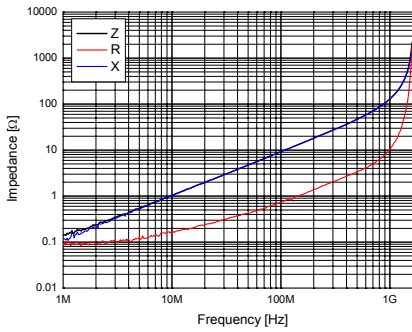

WPB-L1608-110

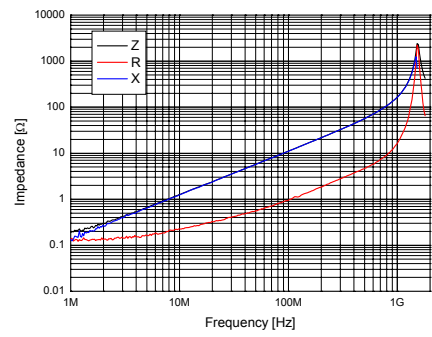

WPB-L1608-130

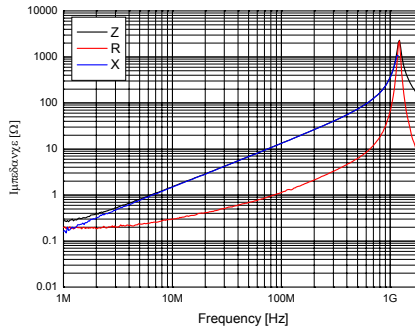

WPB-L1608-150

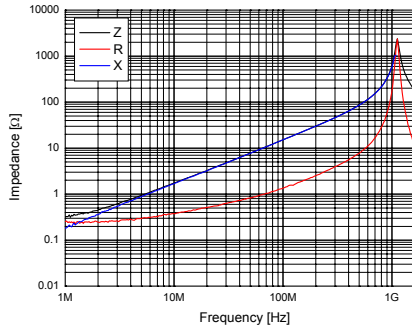

WPB-L2012-3R5

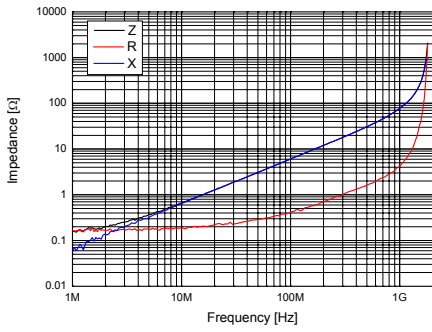

WPB-L2012-6R5

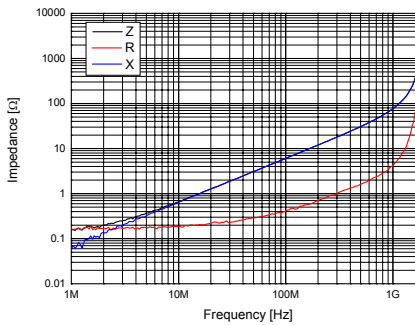

WPB-L2012-100

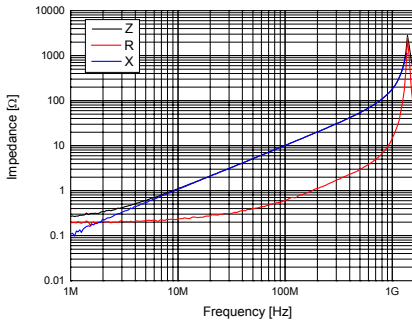

WPB-Y1608-150

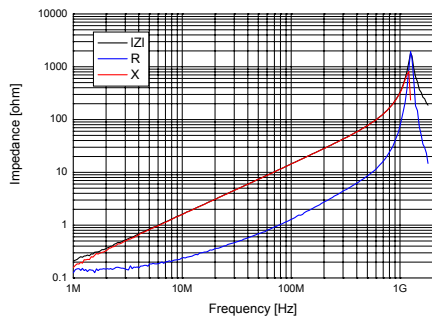

CHIP FERRITE BEADS

WPBH 1005 Series

WPBH-H1005-100

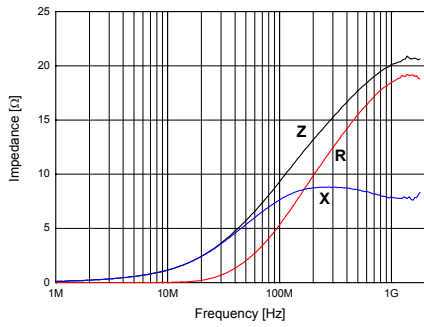

WPBH-M1005-601

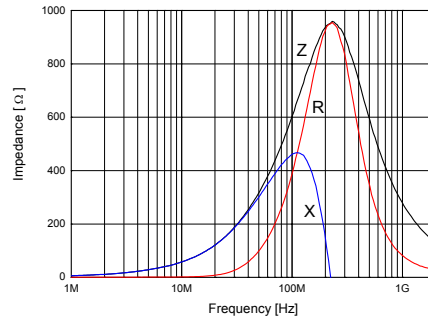

WPBH-M1005-102

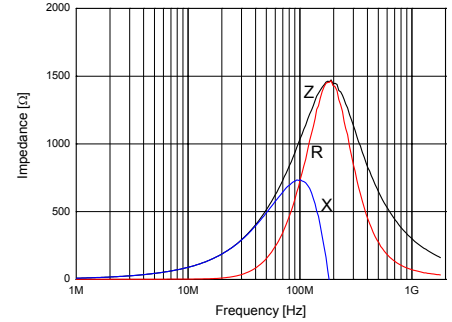

WPBH-S1005-100

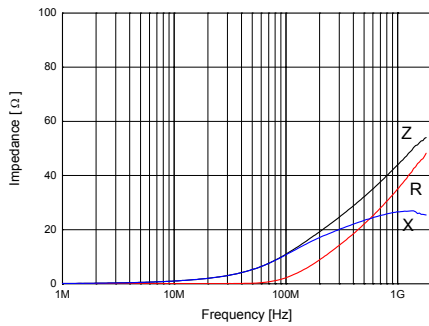

WPBH-T1005-121

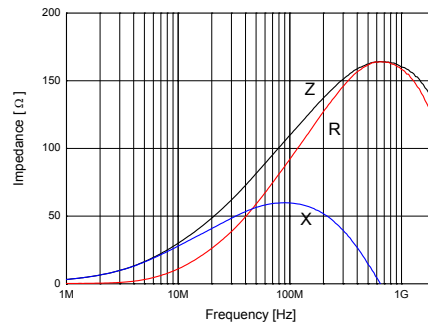

WPBH-T1005-241

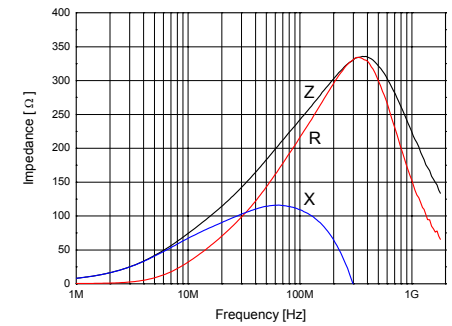

WPBH-T1005-601

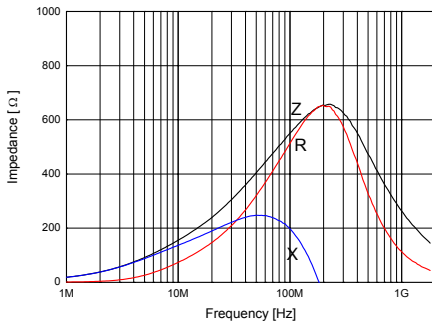

WPBH 1608 Series

WPBH-H1608-300

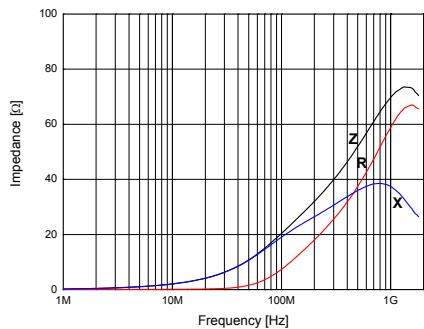

WPBH-M1608-600

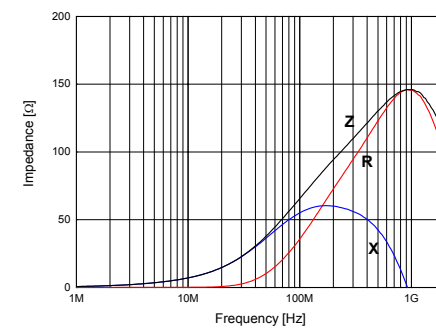

WPBH-M1608-121

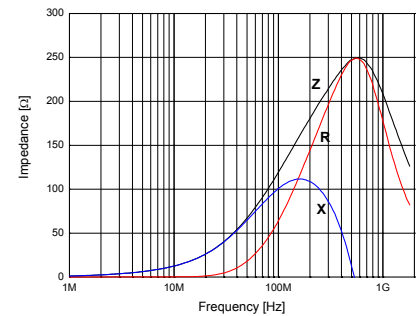

CHIP FERRITE BEADS

WPBH-M1608-221

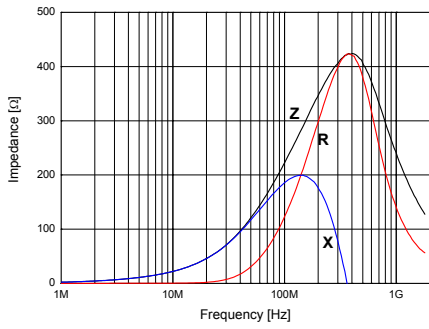

WPBH-M1608-301

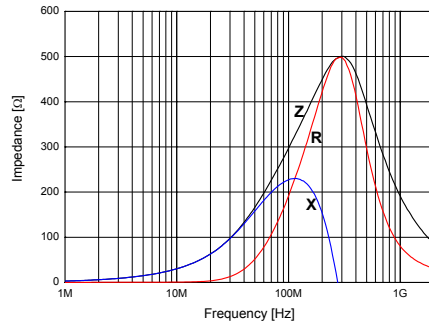

WPBH-M1608-601

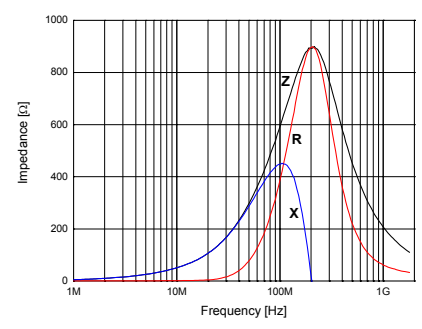

WPBH-M1608-102

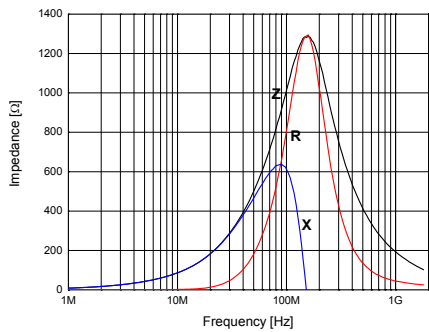

WPBH-S1608-100

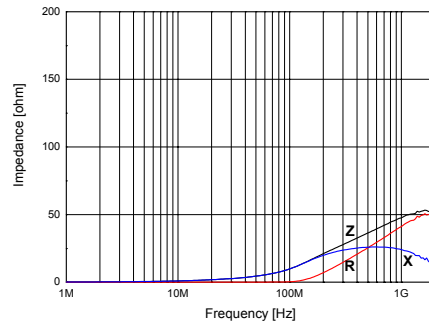

WPBH-S1608-200

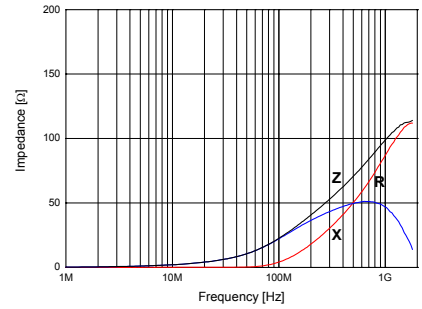

WPBH-S1608-300

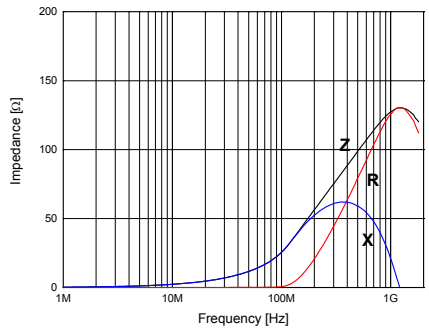

WPBH-S1608-400

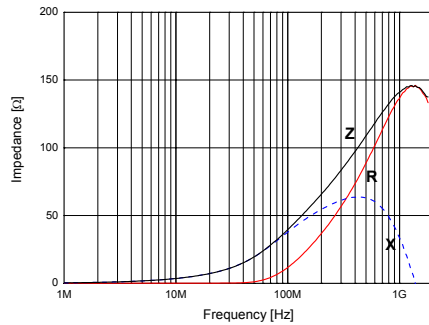

WPBH-S1608-550

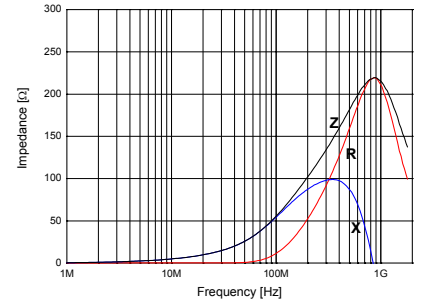

WPBH-S1608-800

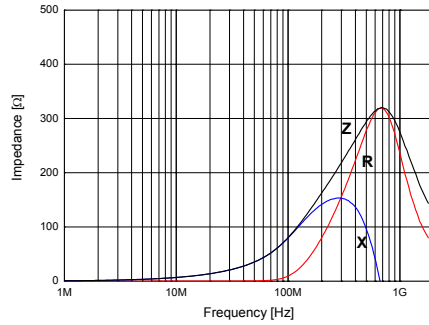

WPBH-S1608-121

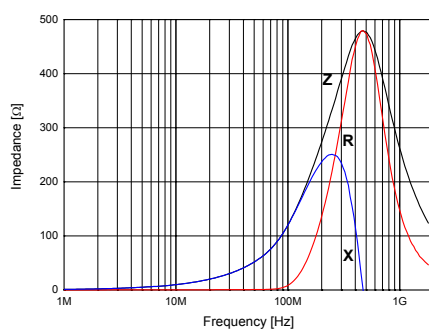

WPBH-S1608-221

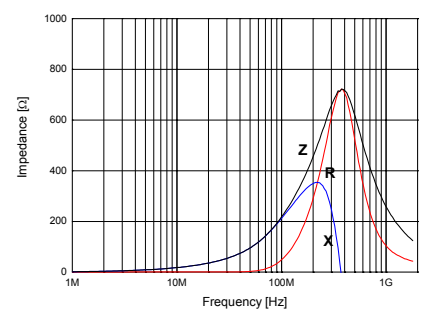

CHIP FERRITE BEADS

WPBH-T1608-300

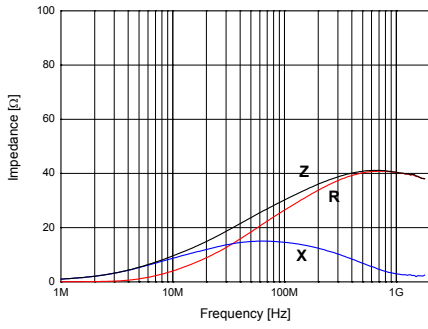

WPBH-T1608-800

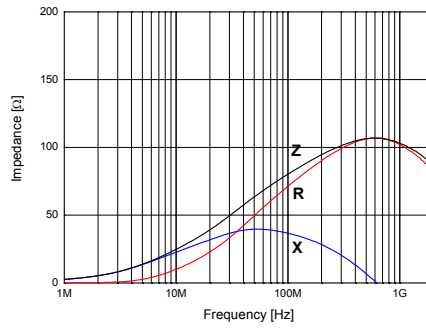

WPBH-T1608-121

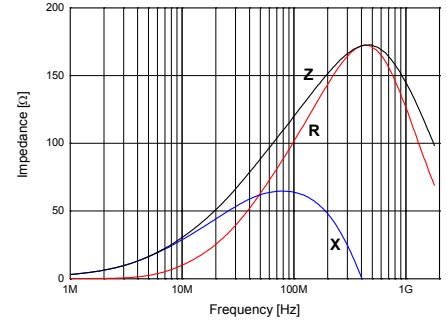

WPBH-M1608-221

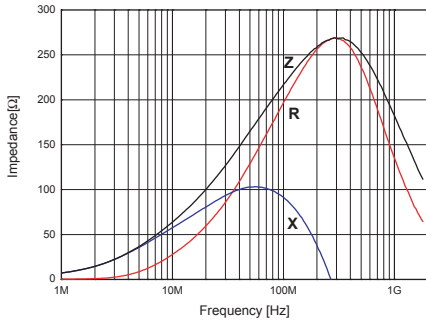

WPBH-T1608-301

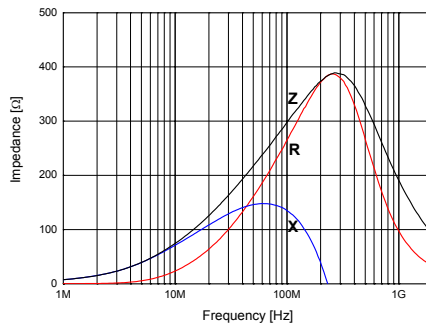

WPBH-T1608-601

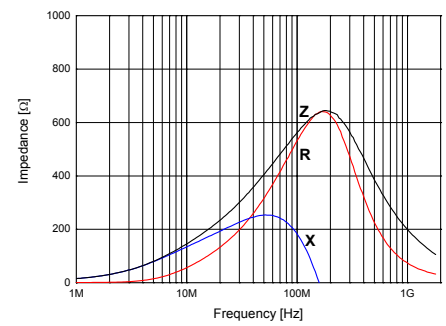

WPBH-T1608-102

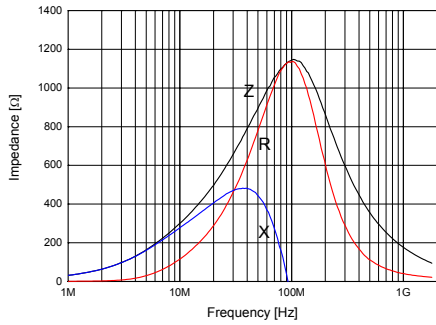

WPBH 2012 Series

WPBH-H2012-150

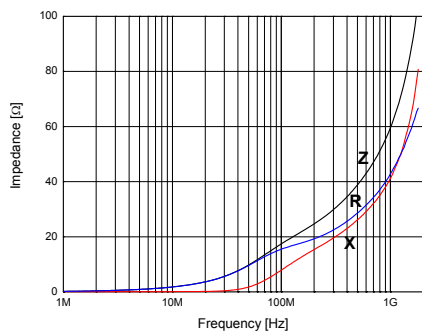

WPBH-H2012-260

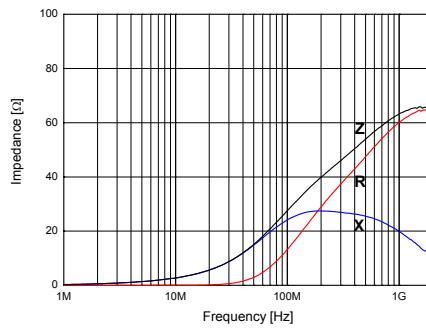

WPBH-H2012-320

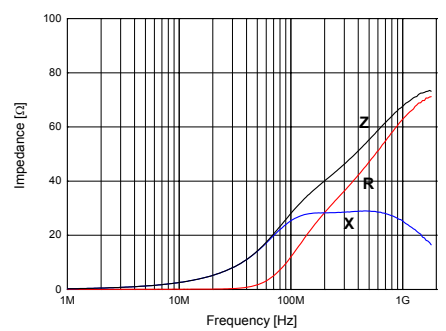

CHIP FERRITE BEADS

WPBH-M2012-800

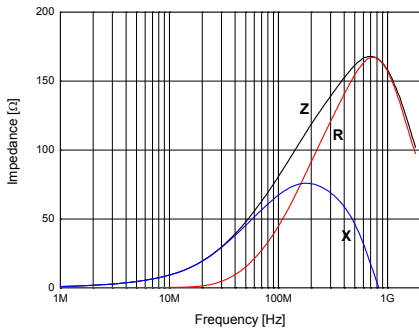

WPBH-M2012-121

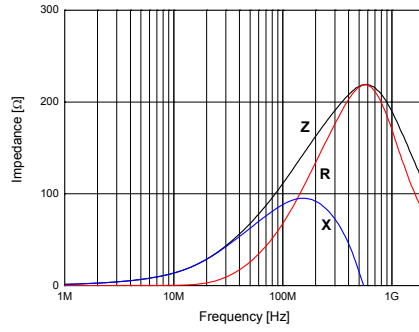

WPBH-M2012-151

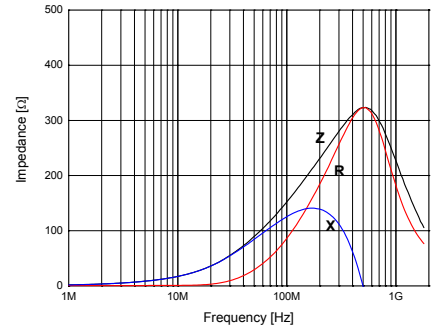

WPBH-M2012-221

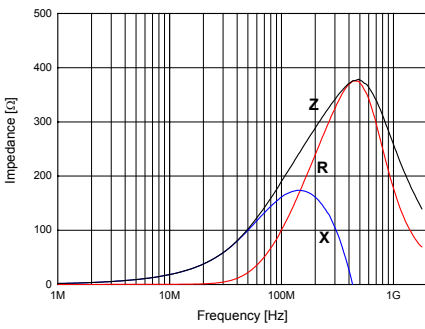

WPBH-M2012-301

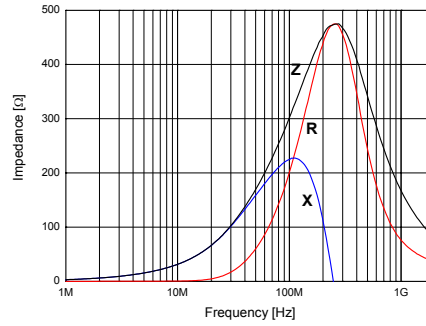

WPBH-M2012-601

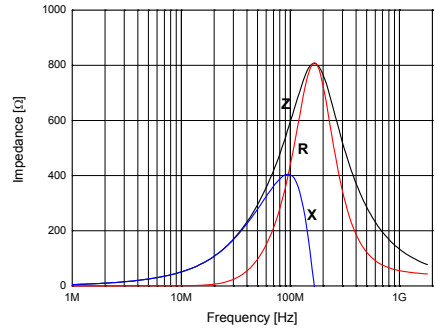

WPBH-M2012-102

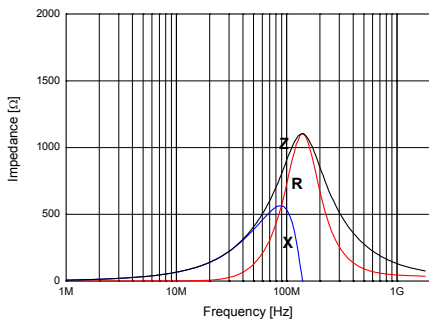

WPBH-M2012-202

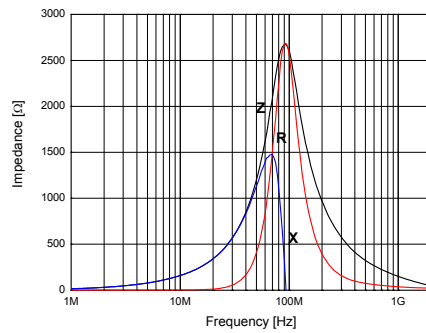

WPBH-S2012-5R0

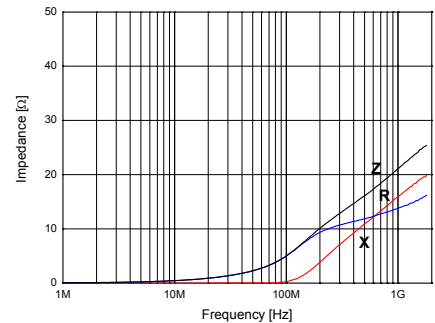

WPBH-S2012-8R0

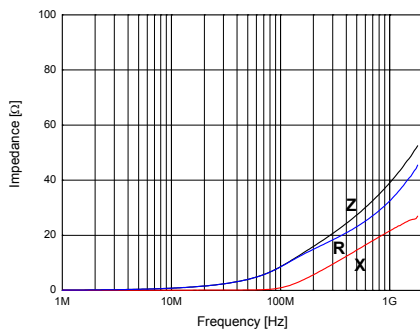

WPBH-S2012-400

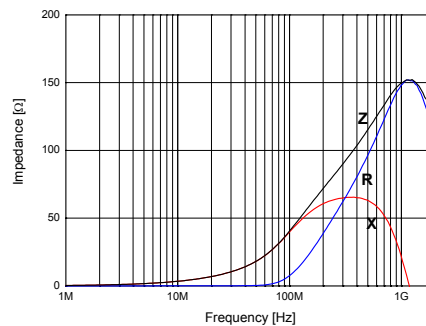

WPBH-S2012-800

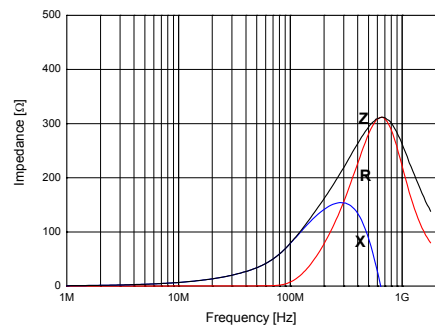

CHIP FERRITE BEADS

WPBH-S2012-121

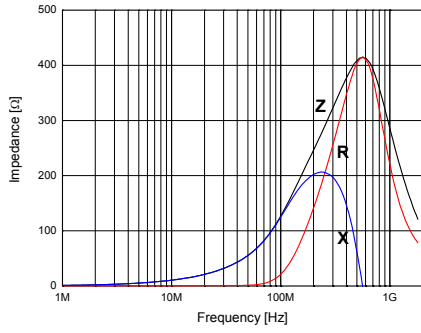

WPBH-S2012-221

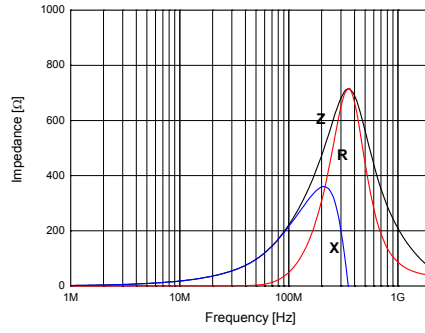

WPBH-T2012-400

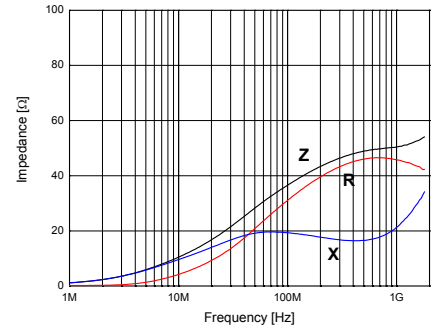

WPBH-T2012-800

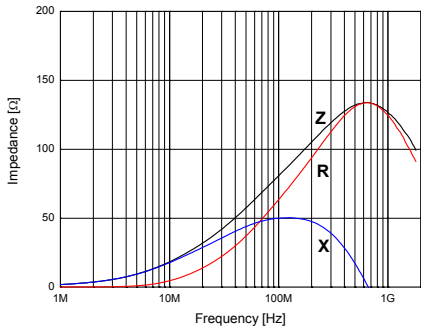

WPBH-T2012-121

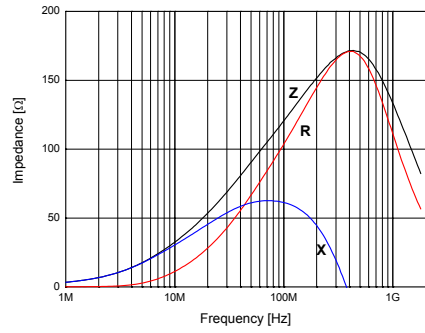

WPBH-T2012-221

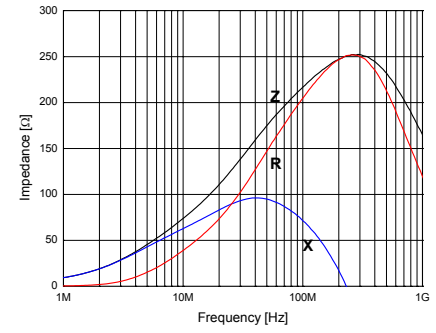

WPBH-T2012-331

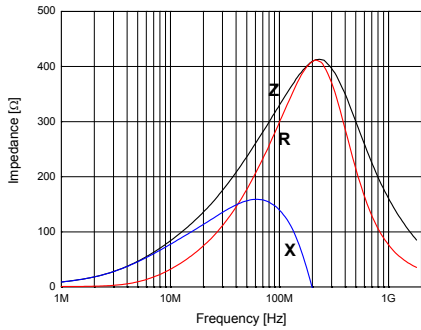

WPBH-T2012-601

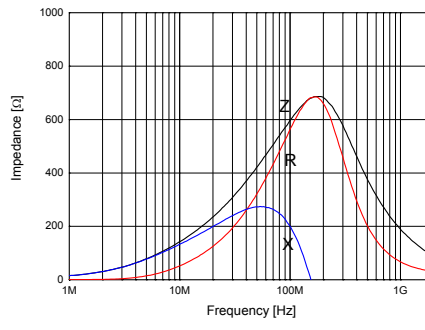

WPBH-T2012-102

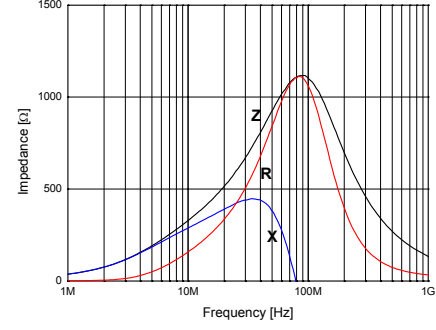

WPBH 3216 Series

WPBH-H3216-500

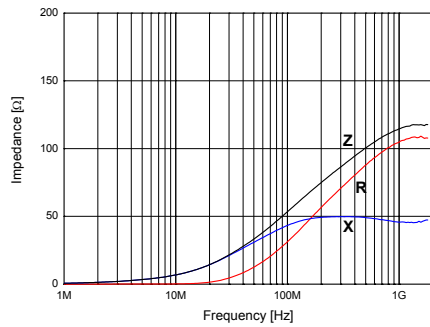

WPBH-H3216-700

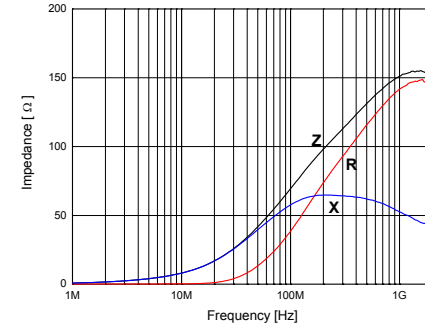

WPBH-M3216-121

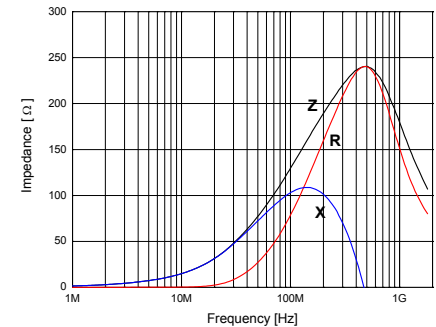

CHIP FERRITE BEADS

WPBH-M3216-151

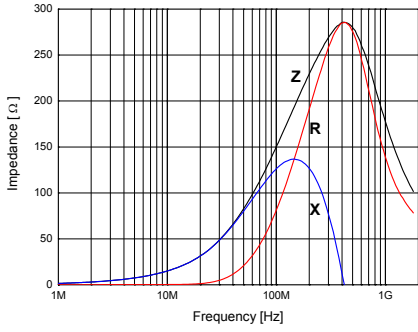

WPBH-M3216-201

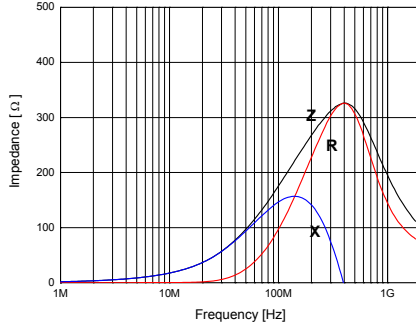

WPBH-M3216-301

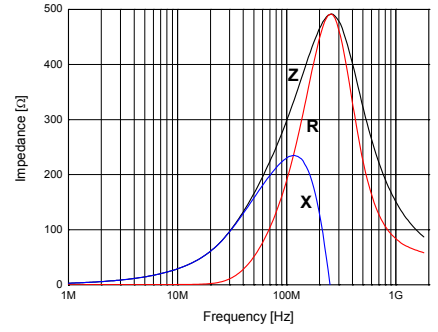

WPBH-M3216-601

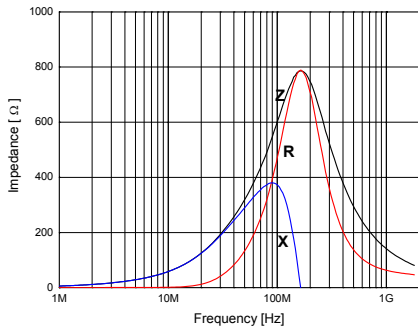

WPBH-M3216-102

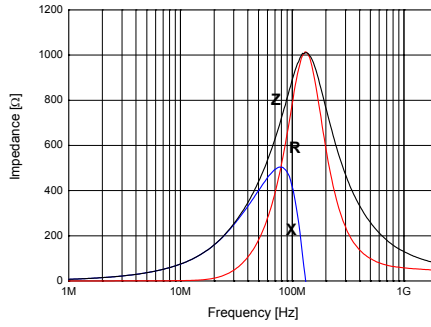

WPBH-S3216-200

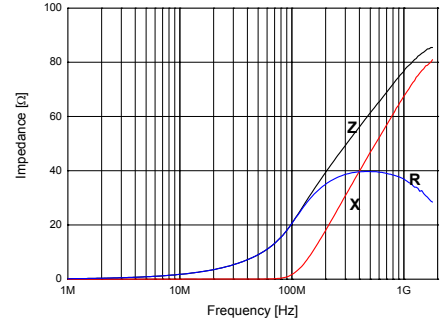

WPBH-S3216-251

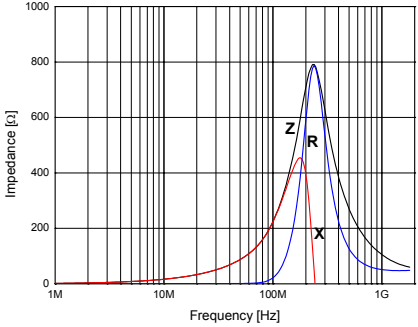

WPBH-T3216-260

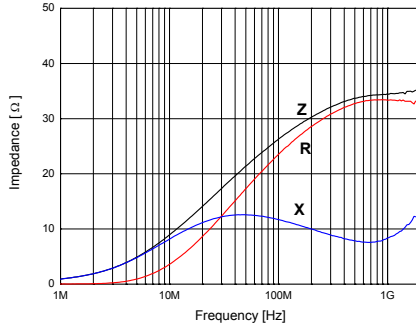

WPBH-T3216-350

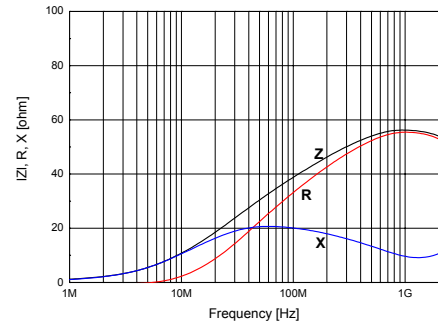

WPBH-T3216-500

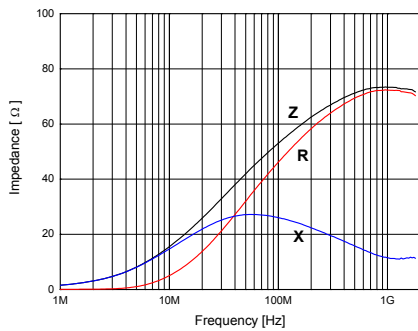

WPBH-T3216-700

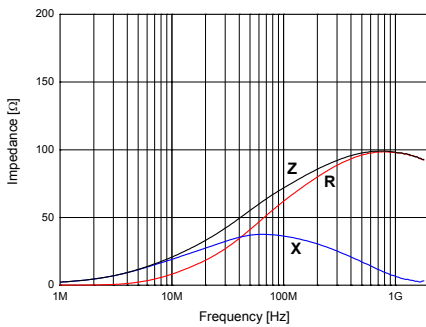

WPBH-T3216-121

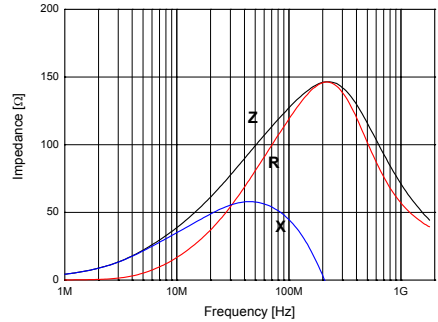

CHIP FERRITE BEADS

WPBH-T3216-151

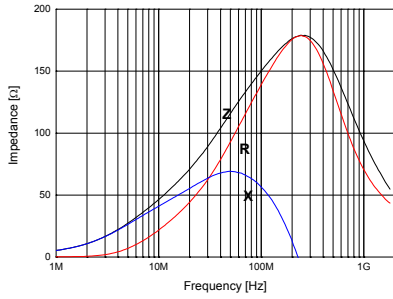

WPBH-T3216-201

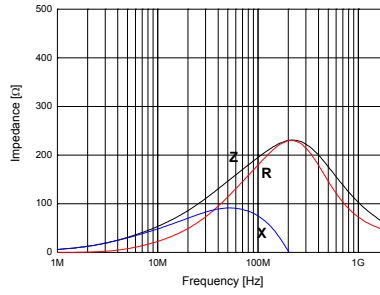

WPBH-T3216-601

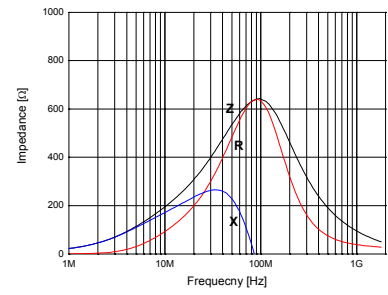

WPBH-T3216-801

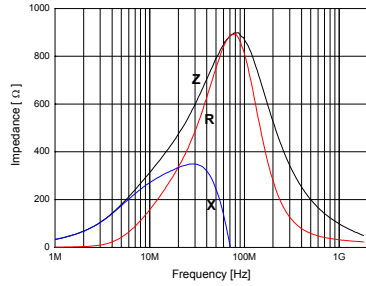

WPBH-T3216-202

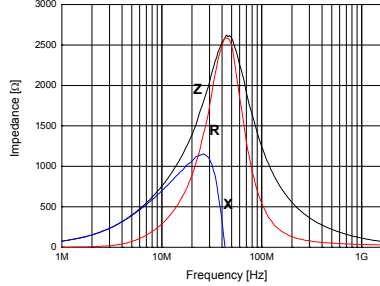

WPBH 4516 Series

WPBH-H4516-600

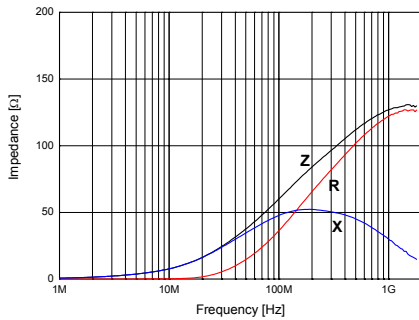

WPBH 4532 Series

WPBH-H4532-121

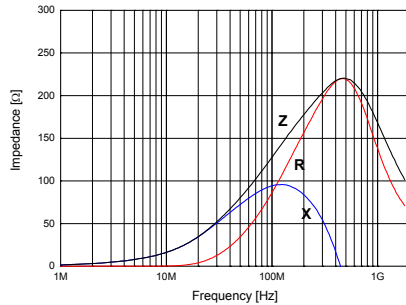

WPBH-T4532-121

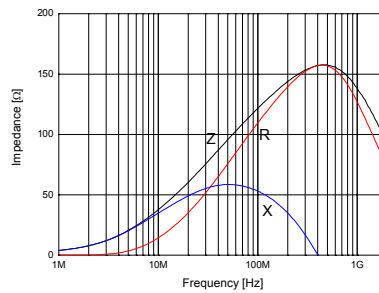

WPBH-M4532-601

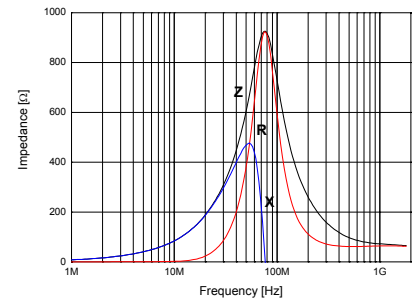

CHIP FERRITE BEADS

WPBH-M4532-132

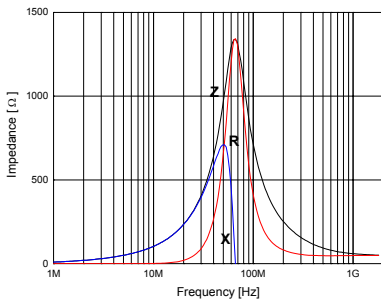

WPBH-B4532-132

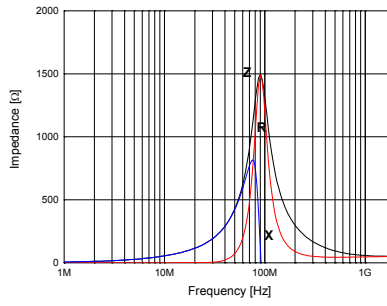

WPBH 5750 Series

WPBH-M5750-401

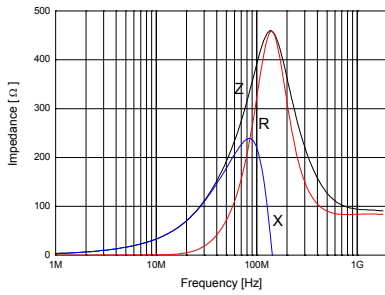

WPBH-5750-501

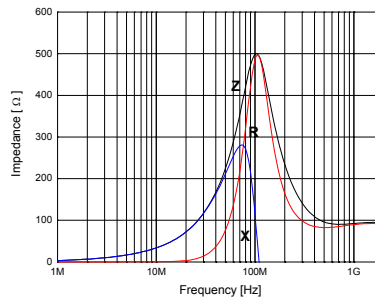

WPBU Series

WPBU-M2012-400

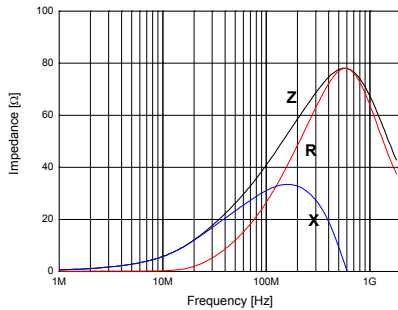

WPBU-M2012-600

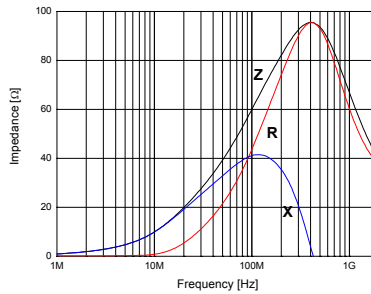

WPBU-M2012-121

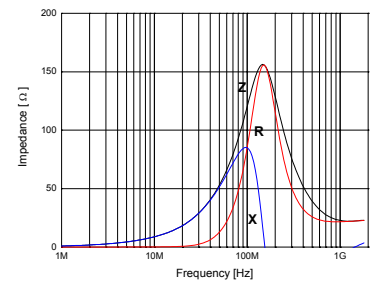

WPBU-T2012-500

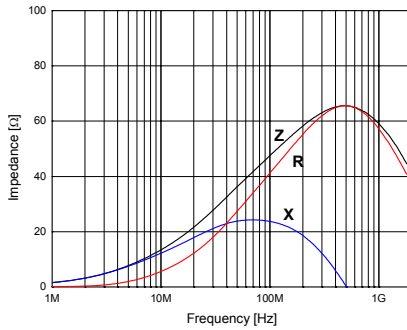

WPBU-H3216-500

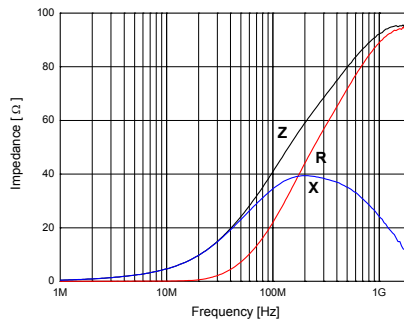

WPBU-H3216-121

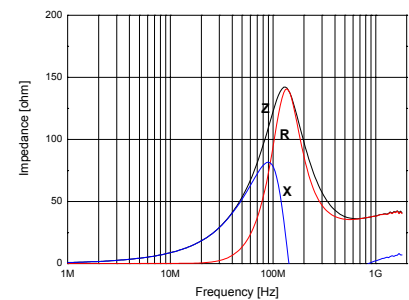

CHIP FERRITE BEADS

WPBU-H4516-600

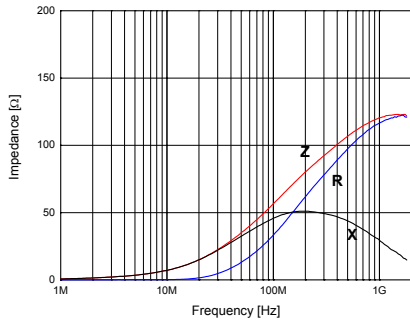

WPBU-B4532-681

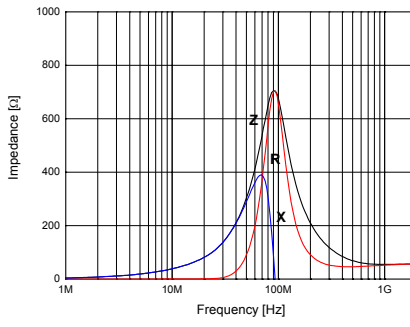

WPBU-M4532-121

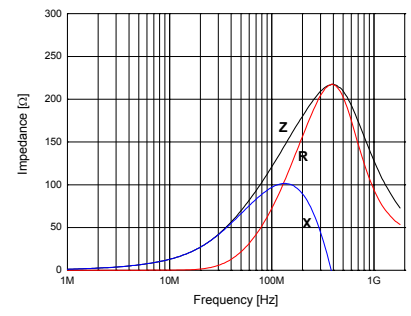

WPBU-M5750-401

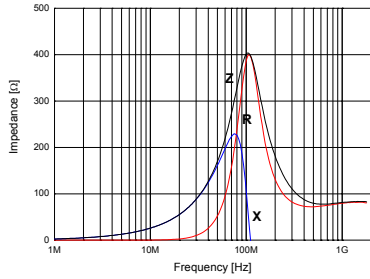

CHIP FERRITE BEADS

Reliability and Test Conditions

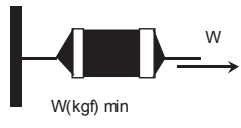
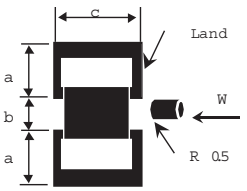
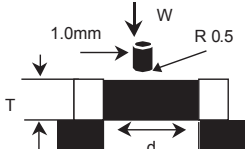
ITEM	REQUIREMENTS							TEST CONDITION	
	1005	1608	2012	3216	4516	4532	5750		
Operating temp.range	-55°C~+125°C							-	
Storage temp. & humidity range	40°C max. , 70% RH max.							at packing condition	
Resistance to solder heat	1. No damage such as cracks should be caused in chip element. 2. More than 75% of the terminal electrode shall be covered with new solder. 3. Impedance change: ±within 30%							Preheat temperature: 100 to 150°C Preheat time: 1min Solder temperature: 260 ± 10°C Dipping time: 10 ± 0.5sec.	
Solderability	1. More than 90% of the terminal electrode shall be covered with new solder. 2. Impedance change : ± within 30%							Preheat temperature: 100 to 150°C Preheat time: 1min Solder temperature: 230 ± 10°C Dipping time: 3 ± 1sec.	
Reflow soldering	1. More than 50% of the terminal electrode shall be covered with new solder. 							Preheat temperature: 150°C Preheat time: 1min Solder temperature: 230°C ± 10°C Soldering time: 10 sec. Max. (Reflow soldering profile)	
Tensile strength (Terminal strength)	1. No mechanical damage. <div style="text-align: right;">Unit : Kgf(W)</div>								
Adhesion of Terminal electrode (Flexure strength)	W	-	1.0	2.0	2.5	2.5	3.0	3.0	
	Unit : mm (a,b,c), Kgf(W)								
	a	0.7	1.0	1.0	1.3	1.5	1.5		1.8
	b	0.5	0.8	1.0	1.5	3.6	3.6		4.6
	c	0.7	1.3	1.3	3.0	3.0	3.8		5.8
d	0.7	2.0	4.0	5.0	5.0	5.0	5.0		
Body strength (Bending strength)	1. The body shall not be damaged by forces applied (see illustration.) <div style="text-align: right;">Unit : mm (d), Kgf(W)</div>								
	d	-	1.3	1.3	2.0	3.0	3.8	4.8	
	W	-	2.0	3.0	4.0	4.0	5.0	5.0	

CHIP FERRITE BEADS

Reliability and Test Conditions

ITEM	REQUIREMENTS							TEST CONDITION
	1005	1608	2012	3216	4516	4532	5750	
Drop	1. No mechanical damage. 2. Impedance change: \pm within 30%.							Drop 10 times on a concrete Floor from a height of 91cm
Vibration	1. No mechanical damage. 2. Impedance change: \pm within 30%.							Frequency: 10~55~10Hz Amplitude: 1.52mm Direction and time: X,Y,Z directions for 2 hours
Thermal shock (Temperature cycle)	1. No mechanical damage. 2. Impedance change: \pm within 30%.							Step1. $-40 \pm 3^{\circ}\text{C}$ 30 \pm 3min. Step2. $85 \pm 3^{\circ}\text{C}$ 30 \pm 3min. Number of cycle: 100 times
Heat load resistance	1. No mechanical damage. 2. Impedance change: \pm within 30%.							Temperature: $85 \pm 2^{\circ}\text{C}$ Applied current: rated current Time: 1,000 hours Measured at room ambient temperature after placing for 24 hours
Low temp. resistance	1. No mechanical damage. 2. Impedance change: \pm within 30%.							Temperature: $-40 \pm 5^{\circ}\text{C}$ Time: 1,000 hours Measured at room ambient temperature after placing for 24 hours
Humidity resistance	1. No mechanical damage. 2. Impedance change: \pm within 30%.							Temperature: $40 \pm 2^{\circ}\text{C}$ Humidity: 90~95% RH Time: 500 hours Measured at room ambient temperature after placing for 24 hours
Humidity load resistance	1. No mechanical damage. 2. Impedance change: \pm within 30%.							Temperature: $40 \pm 2^{\circ}\text{C}$ Humidity: 90~95% RH Applied current: rated current Time: 500 hours Measured at room ambient temperature after placing for 24 hours

Land Pattern Design

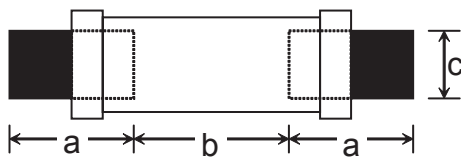

unit: mm

Size	a	b	c
0603	0.22	0.25	0.32
1005	0.7	0.4	0.5
1608	1.0	0.6	0.8
2012	1.0	1.0	1.0
3216	1.1	2.2	1.4
4516	1.5	3.0	1.4
4532	1.8	3.0	3.0
5750	2.0	4.0	5.8

CHIP FERRITE BEADS

Labeling

Label

- 1) Part name.
- 2) Lot No.
- 3) Quantity.

Standard quantity for packing

pcs.

Packing Type(EIA)	Tape & reel			Bulk
	Reel	Inner box	Carton box	Vinyl or Cassette
1005	50,000	500,000	2,000,000	As requested
	30,000	300,000	600,000	
	10,000	100,000	400,000	
1608	8,000	80,000	320,000	
	4,000	40,000	160,000	
2012	3,000	30,000	120,000	
3216	3,000	30,000	120,000	
	7,000	70,000	280,000	
4516	3,000	21,000	84,000	
4532	1,500	10,500	42,000	
5750	1,000	7,000	28,000	

*Packing method can be changed upon request.

Tape Dimensions

Embossing 8mm

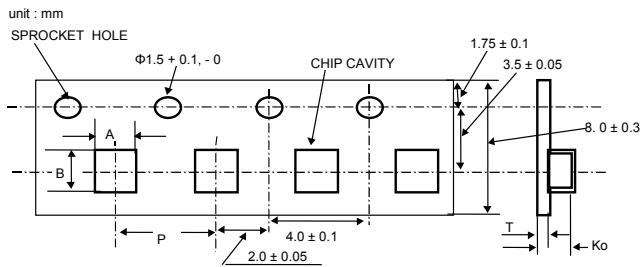

unit : mm

Type	A ± 0.1	B ± 0.1	P ± 0.1	K ₀ ± 0.1	T (max.)
1608	1.00	1.80	4.0	0.95	0.3
	1.45	2.25	4.0	1.00	0.3
2012	1.45	2.25	4.0	1.35	0.3
	1.90	3.60	4.0	1.00	0.3
3216	1.90	3.60	4.0	1.35	0.3

Embossing 12mm

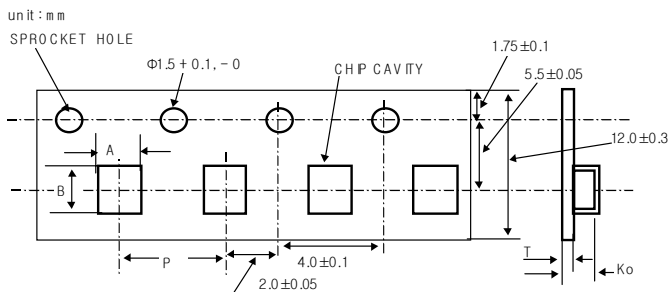

unit : mm

Type	A ± 0.1	B ± 0.1	P ± 0.1	K ₀ ± 0.1	T (max.)
4516	1.90	4.90	4.0	1.00	0.3
	1.90	4.90	4.0	1.35	0.3
4532	3.60	4.90	8.0	1.40	0.3
	3.60	5.10	8.0	0.90	0.3
5750	5.20	6.10	8.0	2.05	0.3

CHIP FERRITE BEADS

Paper

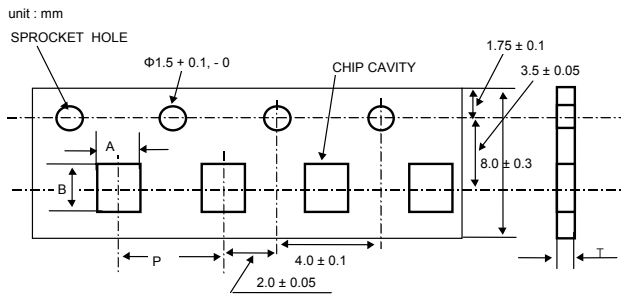

unit: mm

Type	A	B	P	T (max.)
0603	0.38 ± 0.02	0.68 ± 0.02	2.0 ± 0.05	0.44
1005	0.66 ± 0.03	1.18 ± 0.03	2.0 ± 0.05	0.64
1608	1.00 ± 0.10	1.80 ± 0.10	4.0 ± 0.1	1.06

Leader and Blank Portion

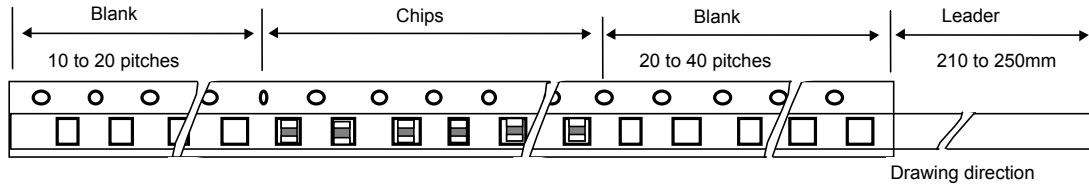

The pitch holes shift within $\pm 0.3\text{mm}$ for cumulative 10 pitches.

CHIP FERRITE BEADS

Reel Dimensions

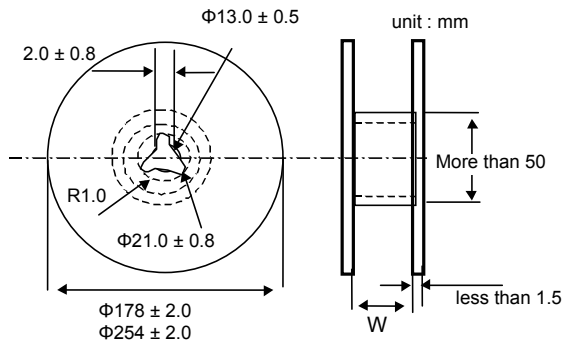

Type	W (mm)
1005, 1608, 2012, 3216	9.0 ± 0.3
4516, 4532, 5750	13.0 ± 0.3

Top Cover Tape Strength

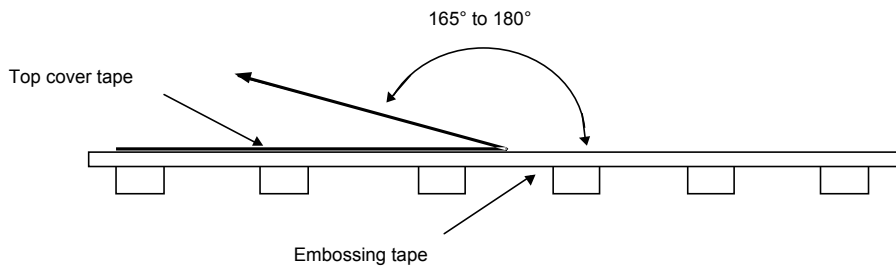

The force for tearing off top cover tape is 20 to 70 grams in the arrow direction.

CHIP FERRITE BEADS

Soldering Profile

REFLOW SOLDERING(Peak 230°C)

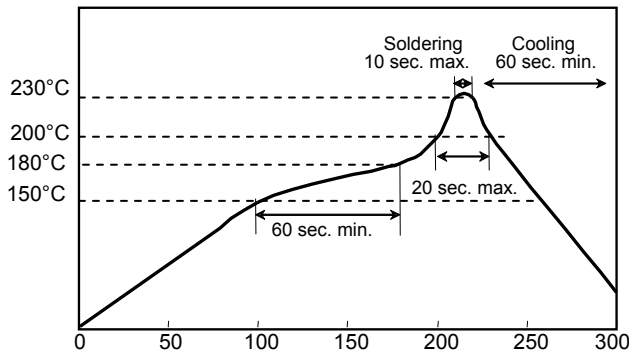

REFLOW SOLDERING (Peak 250°C)

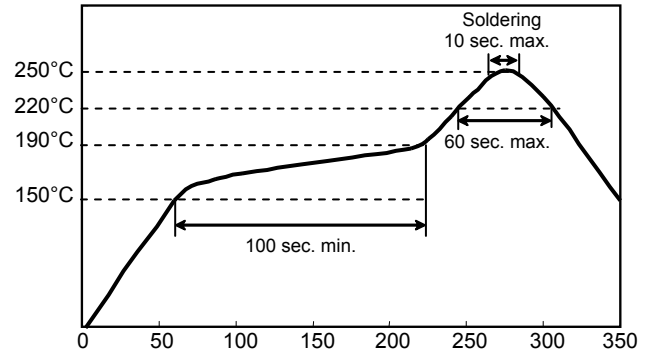

FLOW SOLDERING

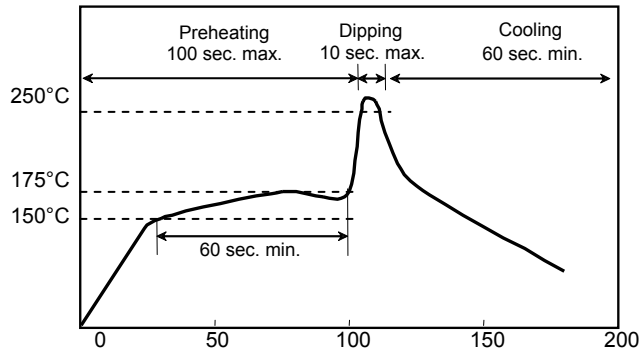

MANUAL SOLDERING

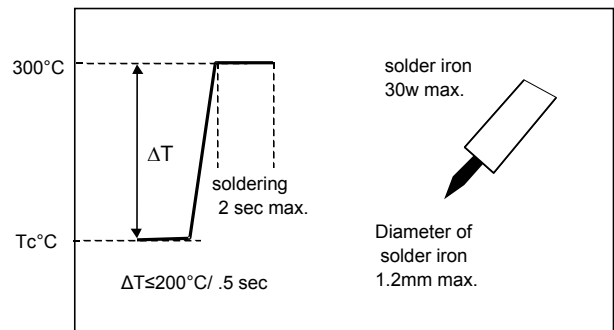

Precaution for Storage

Electrical characteristics of product will not change when stored under typical environmental conditions. However, it is possible that the solderability of terminal electrodes and the characteristics of the tape packaging can change during storage. For this reason, the following storage guidelines should be followed.

1. **Storage Environment:** The tape packaging material is designed to withstand long-term storage but they will degrade more rapidly in the presence of high temperature or high humidity. Therefore, product shall be stored in an ambient temperature of less than 40°C with a relative humidity of less than 70%. The products should be used within 6 months of receipt. To achieve best solderability, product should be used as soon as possible after unpacking. Leftover product must be stored in dry condition with desiccant.
2. **Corrosive gases:** Since sulfur and chlorine may degrade the solderability of the terminal electrodes, it is important to store the product in an environment free of such gases.
3. **Temperature fluctuations:** Dew condensation may occur when the product is taken out of storage due to variation of temperature. It is important to maintain a temperature-controlled environment.

DISCLAIMER: The names of the products and the specifications in this catalog are subject to change without notice for the sake of improvement. World Products Inc. also reserves the right to discontinue any of these products. The products in this catalog are intended for use in ordinary electronic products. If any of these products are to be used in special applications requiring extremely high reliability, where product defects might pose a safety risk, please consult World Products Inc. Though World Products Inc. has taken all possible precautions to ensure the quality and reliability of its products, improper use of products may result in bodily injury, fire, or similar accident. If you have any questions regarding the use of the products in question, please consult World Products Inc. Please be advised that World Products Inc. accepts no responsibility for any infraction by users of World Products Inc. products on third party patents or industrial copyrights.