



CFM130M SERIES

130 WATT MEDICAL AC-DC POWER SUPPLY WITH PFC

Features

- Universal Input Range 80~264Vac
- High Efficiency up to 94%
- 2"x 3" Open Frame Compact Size
- Class I & Class II (NOTE8)
- No Load Input Power Consumption<150mW
- Peak Power Operation up to 150Watt for 5s
- Approval Safety IEC/EN/UL 60601-1 2 MOPP
- Operating Altitude 5000m
- 100W with Natural Convection
- 130W with Fan-Cooled
- Continuous Short Circuit Protection
- Active PFC Function

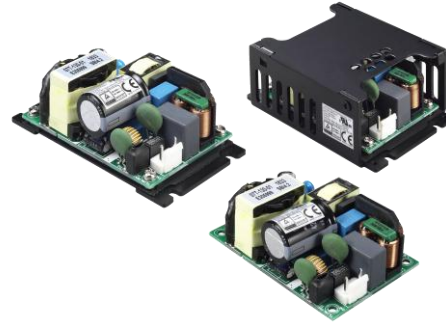

MODEL NUMBER	OUTPUT VOLTAGE	OUTPUT CURRENT		RIPPLE & NOISE NOISE NOTE2	VOLTAGE ACCURACY NOTE1	LINE REGULATION NOTE3	LOAD REGULATION NOTE4	%EFF. (Typ.) NOTE5
		NATURAL CONVECTION	FAN COOLED NOTE7					
CFM130M120	12 V	8.34 A	10.8 A	120 mV	±2%	±0.5%	±1%	93%
CFM130M180	18 V	5.56 A	7.2 A	180 mV	±2%	±0.5%	±1%	93%
CFM130M190	19 V	5.26 A	6.8 A	190 mV	±2%	±0.5%	±1%	93%
CFM130M240	24 V	4.2 A	5.4 A	240 mV	±2%	±0.5%	±1%	93%
CFM130M360	36 V	2.8 A	3.6 A	360 mV	±2%	±0.5%	±1%	94%
CFM130M480	48 V	2.1 A	2.7 A	480 mV	±2%	±0.5%	±1%	94%

Note:

1. Voltage accuracy is set at full load.
2. Add a 0.1uF ceramic capacitor and a 10uF E.L. capacitor to output for ripple & noise measuring @20MHz BW.
3. Line regulation is measured from 100Vac to 240Vac with full load.
4. Load regulation is measured from 10% to 100% full load.
5. Typical efficiency at 230 VAC and 75% full load at 25°C.
6. Standard input and output connectors (CN1 and CN2) wafer with TAIWAN KING PIN TERMINAL PVHI series and mate with JST housing VHR series or equivalent.
7. Requires 10CFM.
8. Conductive: Class I & Class II meets Class B, Radiation: Class I meet Class B, Class II meet Class A.

PART NUMBER

Series	Number of Outputs	Nominal Output Voltage	Type
CFM130	X	XXX	-X (Option)
CFM130	M : MEDICAL	120 : 12V 180 : 18V 190 : 19V 240 : 24V 360 : 36V 480 : 48V	Blank : Wafer B : Base Cooling C : Cover

Part Number Example:

CFM130M120-B: Open Frame, 130W, Medical 12Vdc Output, Base Cooling



CFM130M Series

TECHNICAL SPECIFICATIONS

(All specifications are typical at nominal input, full load at 25°C unless otherwise noted.)

ABSOLUTE MAXIMUM RATINGS

PARAMETER	NOTES and CONDITIONS	Device	Min.	Typ.	Max.	Units
Input Voltage		All	80		264	V _{ac}
Operating Temperature	See derating curve	All	-30		70	°C
Storage Temperature		All	-40		85	°C
Operating Altitude		All			5000	m

INPUT CHARACTERISTICS

PARAMETER	NOTES and CONDITIONS	Device	Min.	Typ.	Max.	Units
Operating Voltage Range		All	100		240	V _{ac}
Input Frequency Range		All	47		63	Hz
Maximum Input Current	100% Load, V _{in} =100V _{ac}	All			1.8	A
Inrush Current	V _{in} =240V _{ac} , Cold start @25°C	All			100	A
Leakage Current		All			100	uA
Under Voltage Protection		All	55	62	70	V _{ac}

OUTPUT CHARACTERISTICS

PARAMETER	NOTES and CONDITIONS	Device	Min.	Typ.	Max.	Units
Output Voltage Set Point	V _{in} =80V _{ac} ~264V _{ac} , I _o =Full load, Ambient temperature=25°C	CFM130M120	11.76	12	12.24	V _{dc}
		CFM130M180	17.64	18	18.36	
		CFM130M190	18.62	19	19.38	
		CFM130M240	23.52	24	24.48	
		CFM130M360	35.28	36	36.72	
		CFM130M480	47.04	48	48.96	
Operating Output Current Range	V _{in} =80V _{ac} ~264V _{ac} , see derating curve	CFM130M120			10.8	A
		CFM130M180			7.2	
		CFM130M190			6.8	
		CFM130M240			5.4	
		CFM130M360			3.6	
		CFM130M480			2.7	
Holdup Time	V _{in} =115V _{ac}	All	20			ms
Output Voltage Regulation						
Load Regulation	10% Load to full load	All			±1.0	%
Line Regulation	V _{in} =High line to low line	All			±0.5	%
Over Voltage Protection	Auto recovery	CFM130M120		13.5		V _{dc}
		CFM130M180		20.5		
		CFM130M190		23		
		CFM130M240		30		
		CFM130M360		42		
		CFM130M480		54		
Peak Power	1. V _{in} =115V _{ac} and 230V _{ac} 2. Ambient temperature=25°C 3. Peak power should be less than 5seconds, with a maximum 10% duty cycle, peak power function by 115% load 5S and 75% load 45S	All		115		%
Over Current Protection	Auto recovery	All	115	130	155	%
Short Circuit Protection	Auto recovery	All				



CFM130M Series

PARAMETER	NOTES and CONDITIONS	Device	Min.	Typ.	Max.	Units
Output Ripple and Noise	1. Add a 0.1uF ceramic capacitor and a 10uF aluminum electrolytic capacitor to output 2. Oscilloscope is 20MHz band width 3. Ambient temperature=25°C	CFM130M120			120	mV
		CFM130M180			180	
		CFM130M190			190	
		CFM130M240			240	
		CFM130M360			360	
		CFM130M480			480	
Load Capacitance	1. Input voltage is 115V _{ac} and 230V _{ac} . 2. Output is max. full load 3. Ambient temperature=25°C	CFM130M120			8400	uF
		CFM130M180			5600	
		CFM130M190			5200	
		CFM130M240			4200	
		CFM130M360			2720	
		CFM130M480			2040	
Efficiency	1. Input voltage is 230V _{ac} 2. Output is 75% full load 3. Ambient temperature=25°C	CFM130M120		93		%
		CFM130M180		93		
		CFM130M190		93		
		CFM130M240		93		
		CFM130M360		94		
		CFM130M480		94		

ISOLATION CHARACTERISTICS

PARAMETER	NOTES and CONDITIONS	Device	Min.	Typ.	Max.	Units
Input to Output	1 Minute (without dielectric breakdown)	All			4400	V _{ac}
Input to Earth (Ground)	1 Minute (without dielectric breakdown)	All			1800	V _{ac}
Output to Earth (Ground)	1 Minute (without dielectric breakdown)	All			1800	V _{ac}
Isolation Resistance	Input to output	All	100			MΩ

FEATURE CHARACTERISTICS

PARAMETER	NOTES and CONDITIONS	Device	Min.	Typ.	Max.	Units
Switching Frequency		All		105		kHz

GENERAL SPECIFICATIONS

PARAMETER	NOTES and CONDITIONS	Device	Min.	Typ.	Max.	Units
MTBF	I _o =100%; T _a =25°C per MIL-HDBK-217F	All	500			k hours
	I _o =100%; T _a =25°C Telcordia SR332		3160			
Humidity	Non-condensing	All			93	% RH
Shock	Meets MIL-STD-810F Table 516.5, TABLE 516.5-I 10ms, each axis 3 times(±X · ±Y · ±Z axis)	All		75		g
Vibration	Meets MIL-STD-810F Table 514.5C-VIII, 15~2000Hz, X · Y · Z axis, 1 hrs (each axis),. total 3 hrs.	All		4		g
Weight		CFM130M		135		grams
		CFM130M-B		170		
		CFM130M-C		218		
Dimensions	Open Frame (Wafer)	All	3.000x2.000x1.201 Inches (76.20x50.80x30.50 mm)			
	B (Base Cooling)		3.598x2.000x1.299 Inches (91.40x50.80x33.00mm)			
	C (Cover)		3.598x2.520x1.358 Inches (91.40x64.00x34.50mm)			
Safety	Class I & Class II, IEC 60601-1, EN 60601-1, ANSI/AAMI ES 60601-1					Ed 3.2
EMC Emission	EN 55011, Class B, IEC 61000-3-2, IEC 61000-3-3, FCC CFR 47 Part 18					



CFM130M Series

GENERAL SPECIFICATIONS

Conducted Disturbance	EN 55011, FCC CFR 47 Part 18 (Class I & Class II meets Class B)	Class B
Radiated Disturbance	EN 55011, FCC CFR 47 Part 18 Class I (Class I Meet Class B; Class II Meet Class A)	Class B
Harmonic Current Emissions	IEC 61000-3-2	Class A
Voltage Fluctuations & Flicker	EN 61000-3-3	Criteria A
EMC Immunity	EN 60601-1-2, IEC 61000-4-2, 3, 4, 5, 6, 8, 11	Ed 4.1
Electrostatic Discharge (ESD)	IEC 61000-4-2 Level 4: Air Discharge: $\pm 15\text{kV}$, Contact Discharge: $\pm 8\text{kV}$	Criterion A
Radio-Frequency, Continuous Radiated Disturbance	IEC 61000-4-3 Level 3: 80~2700MHz, 10V/m	Criterion A
Electrical Fast Transient (EFT)	IEC 61000-4-4 Level 3: $\pm 2\text{kV}$	Criterion A
Surge	IEC 61000-4-5 Level 3: L-N: $\pm 1\text{kV}$, L-E(Ground): $\pm 2\text{kV}$	Criterion A
Conducted Disturbances, Induced by RF Fields	IEC 61000-4-6 Level 2: 0.15~80MHz, 3V	Criterion A
Power Frequency Magnetic Field	IEC 61000-4-8 Level 4: 30A/m	Criterion A
Voltage Dips	IEC 61000-4-11, Dip: 30% IEC 61000-4-11, Dip: >95%	Criterion A
Voltage Interruptions	IEC 61000-4-11 >95% reduction	Criterion B
Application Note Link	CFM130M Series App Notes	

CHARACTERISTIC CURVE

Power Derating Curve

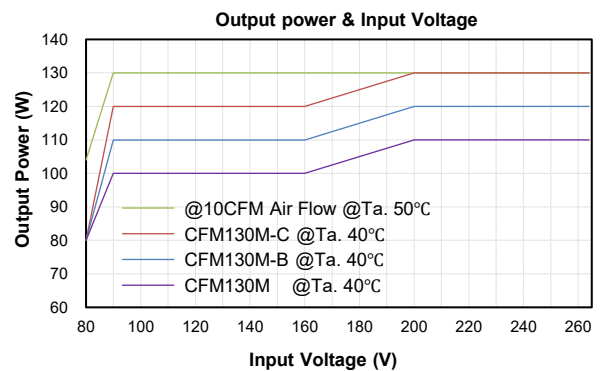
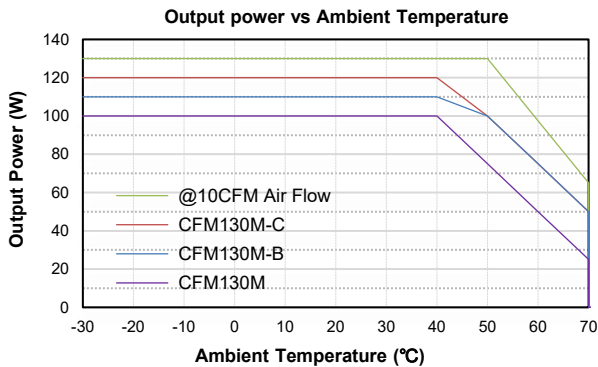

Performance Data

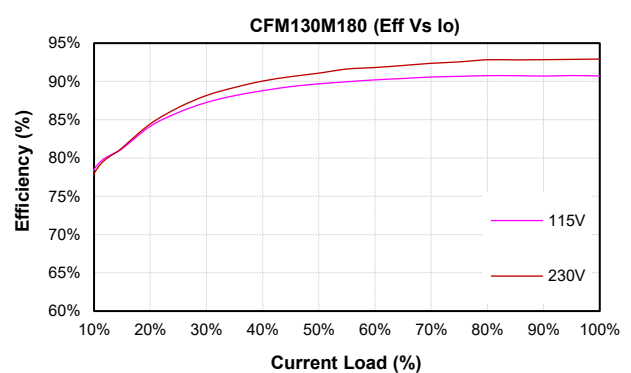
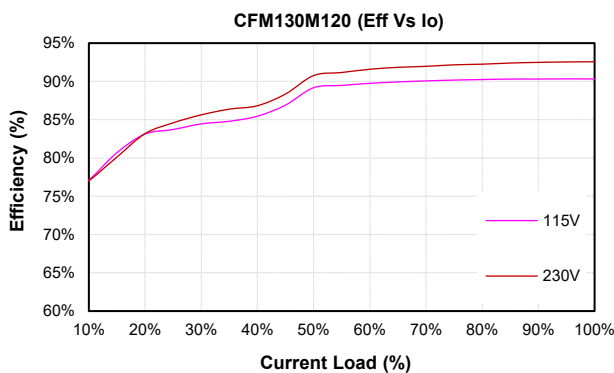



CFM130M Series

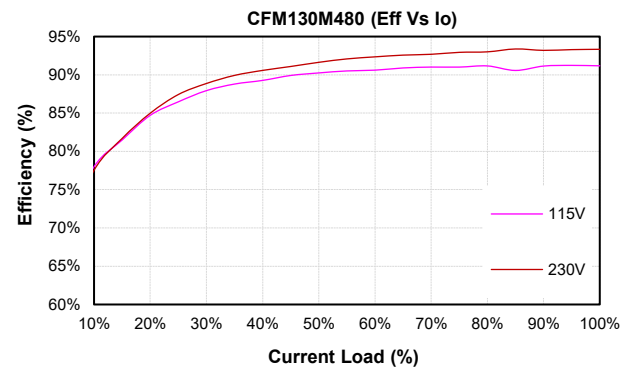
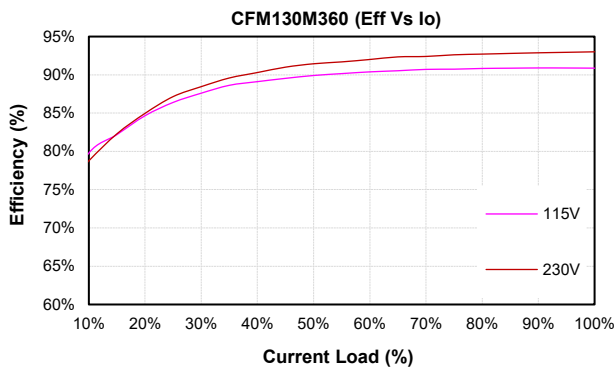
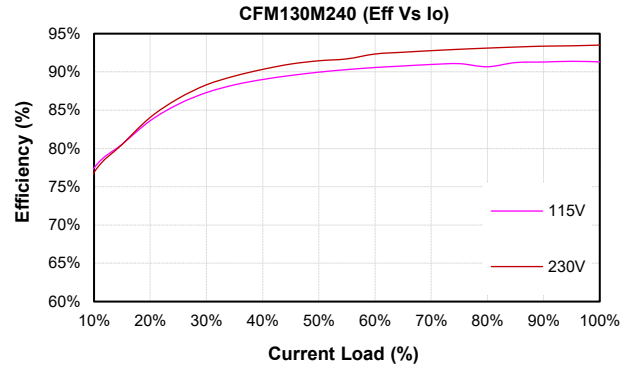
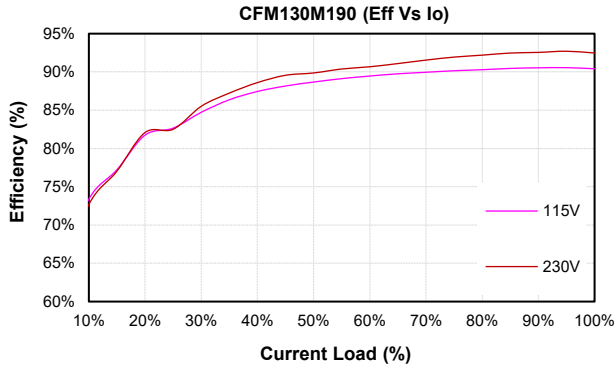



CFM130M Series

MECHANICAL SPECIFICATION

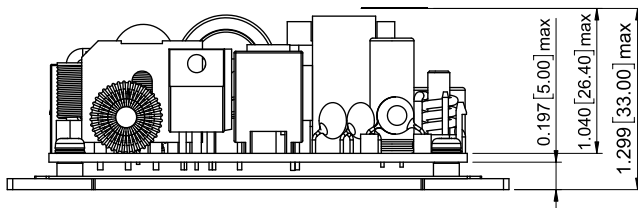
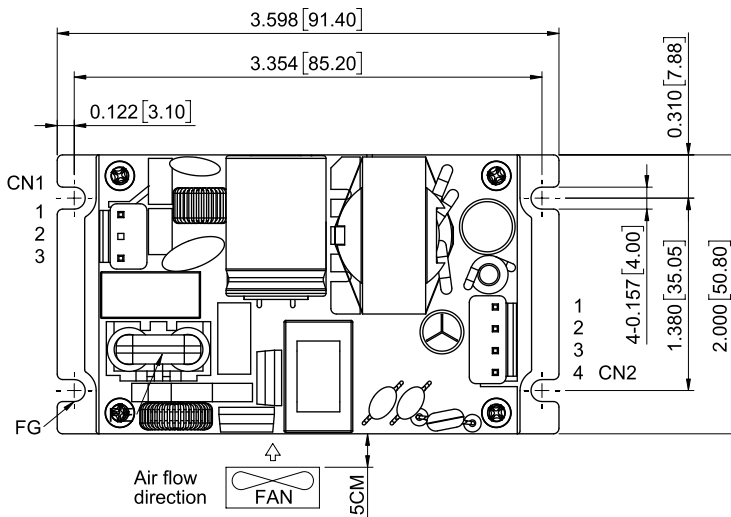
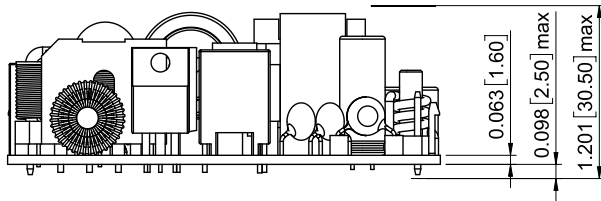
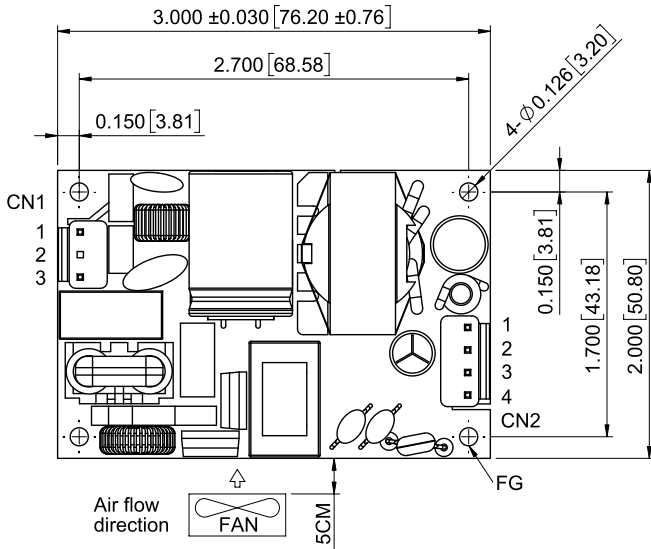

CFM130M

All Dimensions in Inches[mm]
Tolerance Inches: x.xxx=±0.020
Millimeters: x.xx=±0.50

AC Input Connector(CN1):TKP PVHI-03N2 or equivalent

Pin	Function	Mating Housing	Terminal
1	ACL	JST VHR-3N or equivalent	JST SVH-21T-P1.1 or equivalent
2	-		
3	ACN		

DC Output Connector(CN2):TKP PVHI-04 or equivalent

Pin	Function	Mating Housing	Terminal
1	+Vout	JST VHR-4N or equivalent	JST SVH-21T-P1.1 or equivalent
2	+Vout		
3	-Vout		
4	-Vout		

CFM130M-B

All Dimensions in Inches[mm]
Tolerance Inches: x.xxx=±0.020
Millimeters: x.xx=±0.50

AC Input Connector(CN1):TKP PVHI-03N2 or equivalent

Pin	Function	Mating Housing	Terminal
1	ACL	JST VHR-3N or equivalent	JST SVH-21T-P1.1 or equivalent
2	-		
3	ACN		

DC Output Connector(CN2):TKP PVHI-04 or equivalent

Pin	Function	Mating Housing	Terminal
1	+Vout	JST VHR-4N or equivalent	JST SVH-21T-P1.1 or equivalent
2	+Vout		
3	-Vout		
4	-Vout		



CFM130M Series

MECHANICAL SPECIFICATION

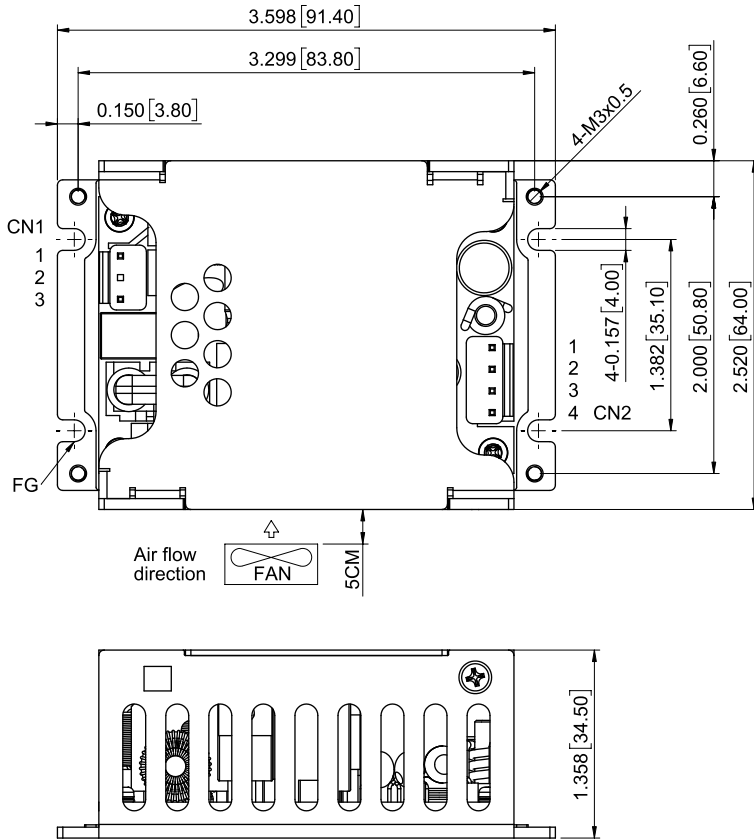

CFM130M-C

All Dimensions in Inches[mm]
 Tolerance Inches: x .xxx=±0.020
 Millimeters: x.xx=±0.50

AC Input Connector(CN1):TKP PVHI-03N2 or equivalent

Pin	Function	Mating Housing	Terminal
1	ACL	JST VHR-3N or equivalent	JST SVH-21T-P1.1 or equivalent
2	-		
3	ACN		

DC Output Connector(CN2):TKP PVHI-04 or equivalent

Pin	Function	Mating Housing	Terminal
1	+Vout	JST VHR-4N or equivalent	JST SVH-21T-P1.1 or equivalent
2	+Vout		
3	-Vout		
4	-Vout		

CINCON Electronics Co. Ltd.
 Add: 14F, No. 306, Sec.4, Hsin Yi Rd., Taipei, Taiwan
 Tel: 886-2-27086210
 Fax: 886-2-27029852
 E-mail: sales@cincon.com
 Web: www.cincon.com