



**N-Channel Enhancement Mode
Power MOSFET 900V / 56A**

Features

- ◆ $V_{DS} = 900V$
- ◆ $R_{DS(ON)} < 146m\Omega @ V_{GS} = 10V$
- ◆ Fully Avalanche Rated
- ◆ Pb Free & RoHS Compliant
- ◆ Isolation Type Package
- ◆ Electrically Isolation Base Plate

Preliminary

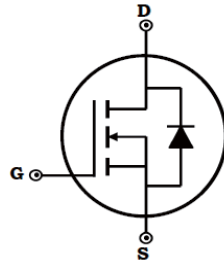

Dimensions in inches and (millimeters)

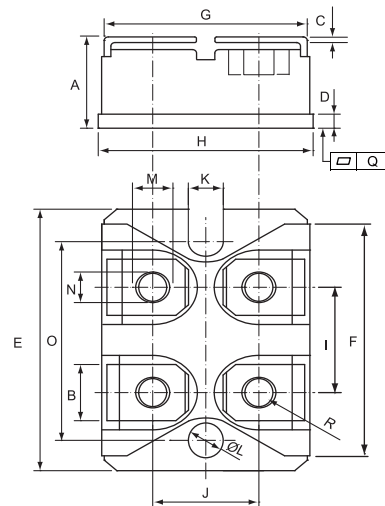

Applications

- ◆ Switch-Mode and Resonant-Mode Power Supplies
- ◆ Robotics and Servo Controls
- ◆ AC and DC Motor Drives
- ◆ Laser Drivers
- ◆ DC-DC Converters

Absolute Maximum Ratings (Tc=25°C unless otherwise noted)

Parameter	Symbol	Ratings	Unit
Drain-Source Voltage	V_{DS}	900	V
Gate-Source Voltage	V_{GS}	±30	V
Drain Current-Continuous @ Tc = 25°C @ Tc = 100°C	I_D	56 32	A
Drain Current-Pulsed @ Tc = 25°C	I_{DM}	168	A
Maximum Power Dissipation	P_D	1000	W
Storage Temperature Range	T_{STG}	-50 to +150	°C
Operating Junction Temperature Range	T_J	-50 to +150	°C
Thermal Resistance, Junction-to-Case	$R_{\theta JC}$	0.125	°C/W
Isolation Voltage (A.C. 1 minute) between All Terminals and Baseplate	V_{iso}	2500	V
Mounting torque (M4 Screw) To heatsink To terminals	M_d	1.3 1.1	Nm

	DIMENSIONS			
	INCHES		MM	
	MIN	MAX	MIN	MAX
A	0.460	0.483	11.68	12.28
B	0.307	0.323	7.80	8.20
C	0.030	0.033	0.75	0.85
D	0.071	0.081	1.80	2.05
E	1.488	1.504	37.80	38.20
F	1.248	1.260	31.70	32.00
G	0.917	0.957	23.30	24.30
H	0.996	1.008	25.30	25.60
I	0.579	0.602	14.70	15.30
J	0.492	0.516	12.50	13.10
K	0.161	0.169	4.10	4.30
L	0.161	0.169	4.10	4.30
M	0.181	0.197	4.60	5.00
N	0.165	0.181	4.20	4.60
O	1.181	1.197	30.00	30.40
Q	-0.002	0.004	-0.05	0.10
R	M4*8			



Electrical Characteristics @ T_J = 25°C (unless otherwise specified)

Parameter	Symbol	Conditions	Min.	Typ.	Max.	Unit
OFF Characteristics						
Drain-Source Breakdown Voltage	BV _{DSS}	V _{GS} =0V , I _{DS} =3mA	900	-	-	V
Zero Gate Voltage Drain Current	I _{DSS}	V _{GS} =0V , V _{DS} =900V	-	-	50	μA
Gate-Source Leakage Current	I _{GSS}	V _{GS} =±30V , V _{DS} =0V	-	-	±200	nA
ON Characteristics						
Gate Threshold Voltage	V _{TH}	V _{DS} =V _{GS} , I _{DS} =1mA	3.5	-	6.5	V
Drain-Source On-State Resistance	R _{DS(on)}	V _{GS} =10V , I _{DS} =28A	-	-	146	mΩ
Gate Resistance	R _G		-	1	-	Ω
Forward Transconductance	g _{fs}	V _{DS} =30V , I _D =28A	-	56	-	S
Dynamic Characteristics						
Input Capacitance	C _{iss}	V _{DS} =25V	-	21	-	nF
Output Capacitance	C _{oss}	V _{GS} =0V	-	1194	-	pF
Reverse Transfer Capacitance	C _{rss}	Freq.=1MHz	-	105	-	
Switching Characteristics						
Turn-On Delay Time	t _{d(on)}	V _{DS} =450V	-	129.4	-	ns
Rise Time	t _r	V _{GS} =10V	-	11.2	-	
Turn-Off Delay Time	t _{d(off)}	I _{DS} =28A	-	136.8	-	
Fall Time	t _f	R _G =1Ω	-	16.2	-	
Total Gate Charge at 10V	Q _g	V _{DS} =450V	-	148	-	nC
Gate to Source Charge	Q _{gs}	V _{GS} =10V	-	57	-	
Gate to Drain Charge	Q _{gd}	I _{DS} =28A	-	49	-	
Reverse Diode Characteristics						
Drain-Source Diode Forward Voltage	V _F	T _J =25°C , I _F =56A ^{Note1}	-	-	1.5	V
Diode Continuous Forward Current	I _F		-	-	56	A
Diode Pulsed Current	I _{F,pulse}		-	-	225	A
Reverse Recovery time	T _{rr}		-	-	600	ns
Reverse Recovery Charge	Q _{rr}	I _F =28A , V _R =450V , -di/dt=150A/us	-	30	-	μC
Peak Reverse Recovery Current	I _{RM}		-	75	-	A

Note:

1. Pulse Test: t ≤ 300 μs, Duty Cycle , d ≤ 2%.



Typical Characteristics

Fig. 1. Maximum Drain Current vs. Case Temperature

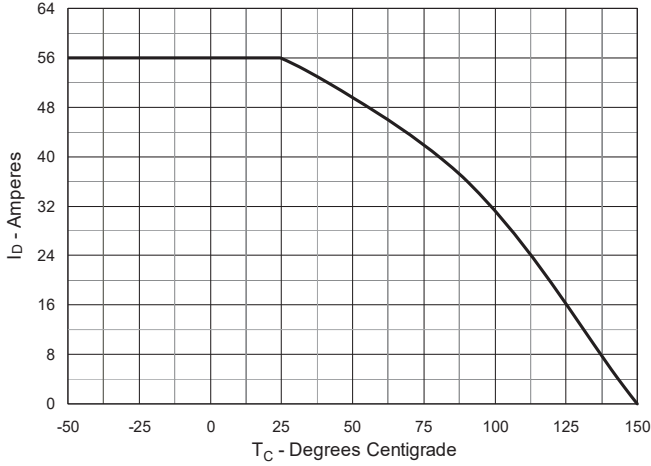

Fig. 2. Extended Output Characteristics @ $T_J = 25^\circ\text{C}$

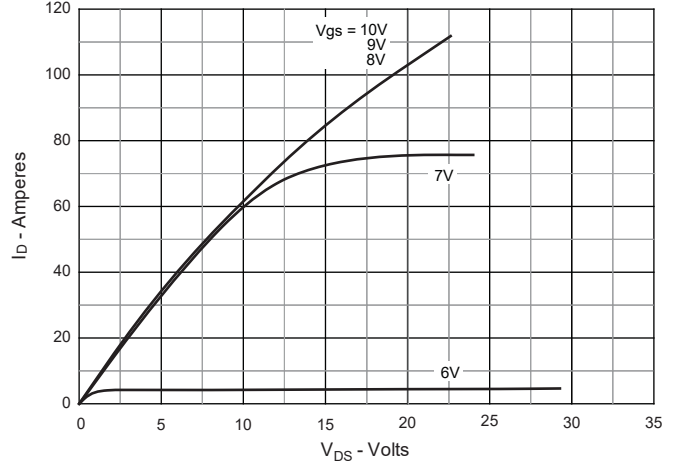

Fig. 3. Output Characteristics @ $T_J = 125^\circ\text{C}$

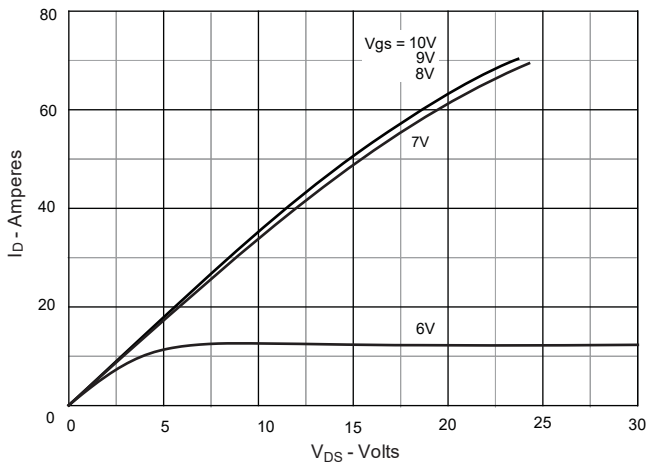

Fig. 4. $R_{DS(on)}$ Normalized to $I_D = 28\text{A}$ Value vs. Drain Current

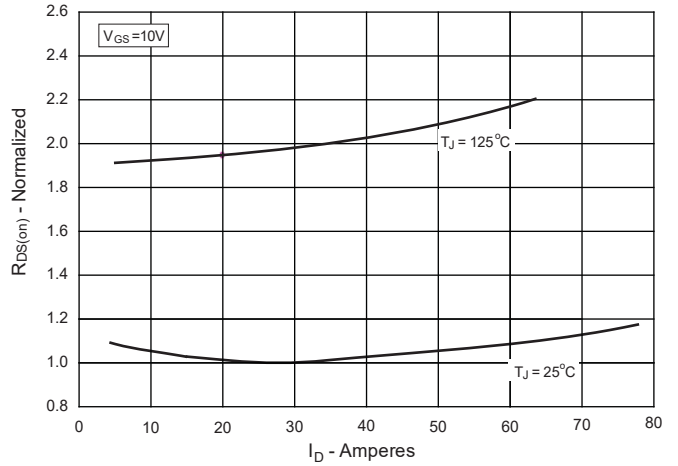

Fig. 5. Input Admittance

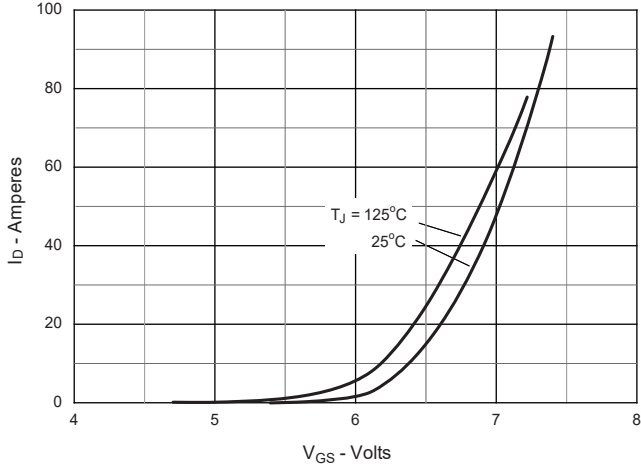
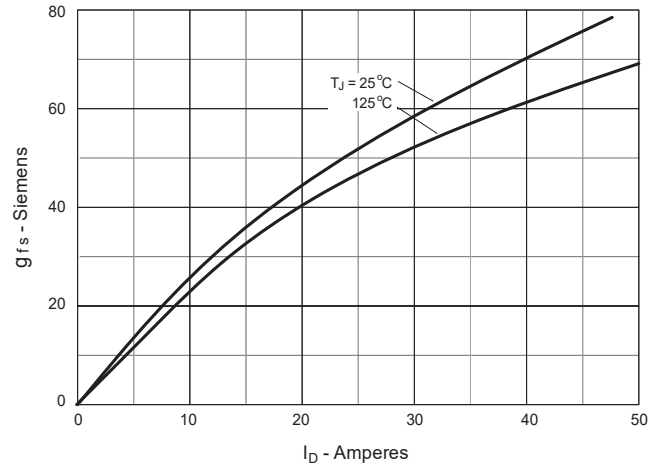

Fig. 6. Transconductance





Typical Characteristics

Fig. 7. Forward Voltage Drop of Intrinsic Diode

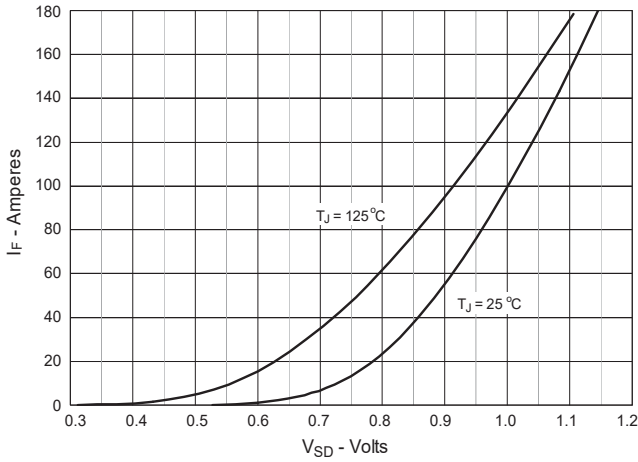

Fig. 8. Gate Charge

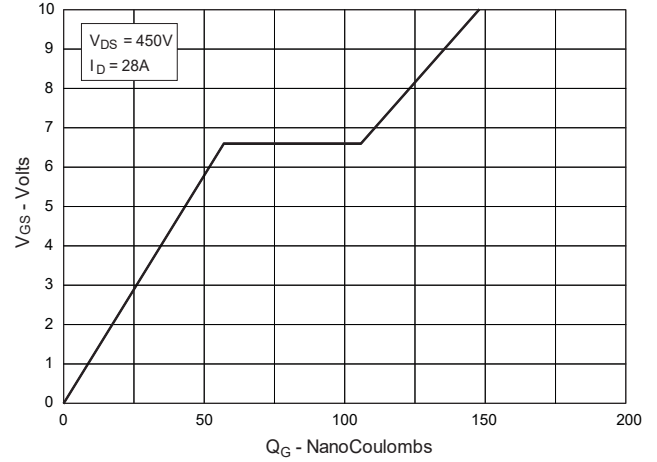

Fig. 9. Capacitance

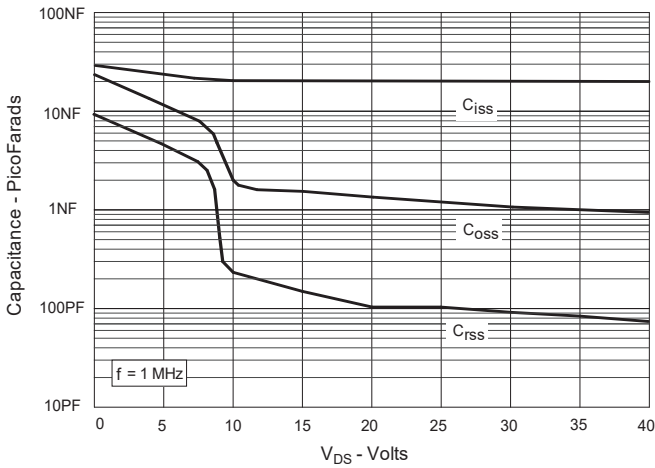

Fig. 10. Forward derating curve of reverse diode

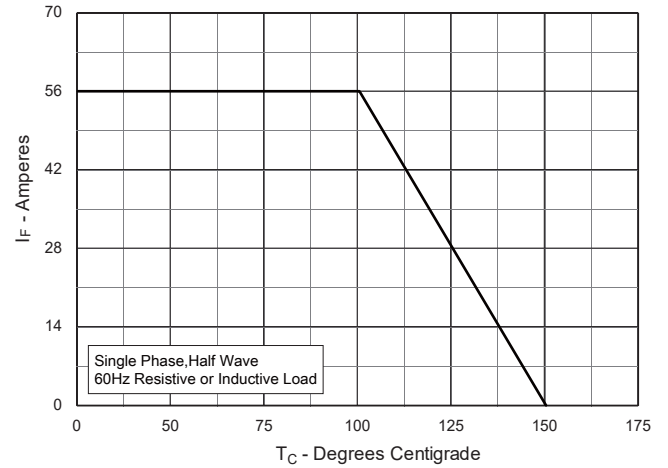

Fig 11. Peak forward surge current of reverse diode

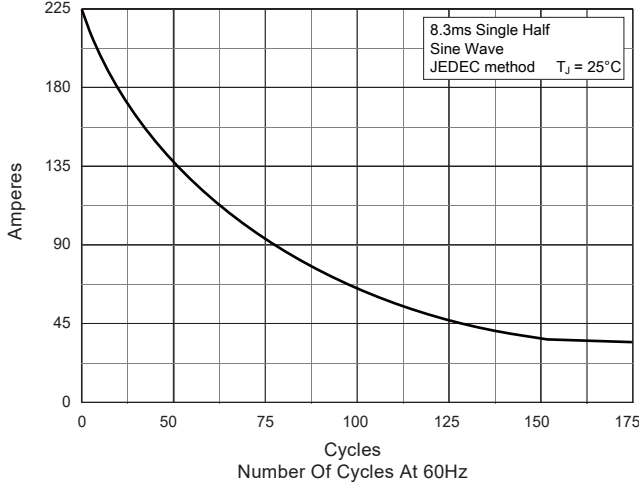
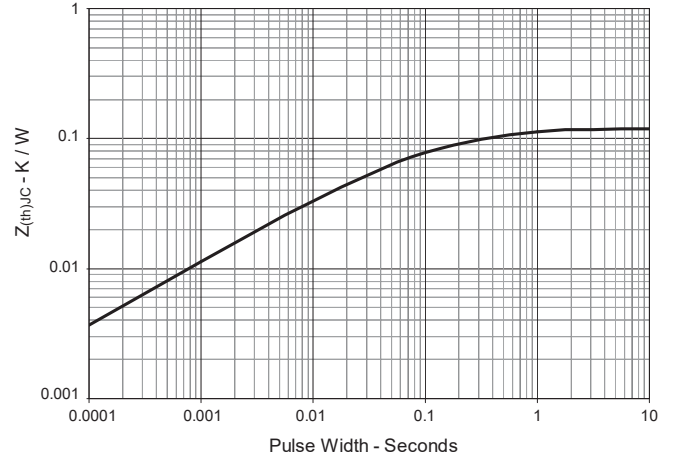

Fig 12. Maximum Transient Thermal Impedance





Disclaimer

DACO Semiconductor reserves the right to make modifications, enhancements, improvements, corrections, or other changes to this document and any product described herein without prior notice.

DACO Semiconductor makes no warranty, representation, or guarantee regarding the suitability of its products for any particular purpose, nor does DACO Semiconductor assume any liability arising out of the application or use of any product or circuit, and specifically disclaims any liability, including without limitation special, consequential or incidental damages.

Purchasers are responsible for its products and applications using DACO Semiconductor products, including compliance with all laws, regulations, and safety requirements or standards, regardless of any support or application information provided by DACO Semiconductor. "Typical" parameters that may be provided in DACO Semiconductor datasheets and/or specifications can and do vary in different applications and actual performance may vary over time. All operating parameters, including "Typical" must be validated for each customer application by the customer's technical experts.

DACO Semiconductor products are not designed, authorized, or warranted to be suitable for use in life support, life-critical or safety-critical systems, or equipment, nor in applications where failure or malfunction of DACO Semiconductor's product can reasonably be expected to result in personal injury, death or severe property or environmental damage. DACO Semiconductor accepts no liability for the inclusion and/or use of DACO Semiconductor's products in such equipment or applications and therefore such inclusion and/or use is at the customer's own risk.

Purchasers who buy or use DACO Semiconductor products for any unintended or unauthorized applications are required to indemnify and absolve DACO Semiconductor, its suppliers, and distributors from any claims, costs, damages, expenses, and reasonable attorney fees arising out of, directly or indirectly, any claim of personal injury or death associated with such unintended or unauthorized use, even if such claim alleges that DACO Semiconductor was negligent regarding the design or manufacture of the part.

No part of this publication may be reproduced or transmitted in any form or by any means, electronic or mechanical, including photocopying and recording, or by any information storage and retrieval system, or otherwise, without the prior written permission of DACO Semiconductor Co., Ltd.